

# SPECIFICATION

Device Name : Power MOSFET

---

Type Name : 2SK3613-01

---

Spec. No. : **MS5F5124**

---

Date : Jan.-18- 2002

---

This material and the information herein is the property of Fuji Electric Co.,Ltd. They shall be neither reproduced, copied, lent, or disclosed in any way whatsoever for the use of any third party nor used for the manufacturing purposes without the express written consent of Fuji Electric Co.,Ltd.

Fuji Electric Co.,Ltd.  
Matsumoto Factory

	DATE	NAME	APPROVED	Fuji Electric Co.,Ltd.		
DRAWN	Jan.-18-'02	H. Tokunishi		DWG. NO.	<b>MS5F5124</b>	1 / 21
CHECKED	Jan.-18-'02	T. HOSEN				
CHECKED	Jan.-18-'02	M. Watanabe				

# Revised Records

Date	Classification	Index	Content	Drawn	Checked	Checked	Approved
Jan.-18 2002	enactment	—	—————	H. Tokunishi	T. HOSEN	M. Wakasa	

This material and the information herein is the property of Fuji Electric Co.,Ltd. They shall be neither reproduced, copied, lent, or disclosed in any way whatsoever for the use of any third party nor used for the manufacturing purposes without the express written consent of Fuji Electric Co.,Ltd.

**Fuji Electric Co.,Ltd.**

DWG. NO.

**MS5F5124**

2 / 21

This material and the information herein is the property of Fuji Electric Co.,Ltd. They shall be neither reproduced, copied, lent, or disclosed in any way whatsoever for the use of any third party nor used for the manufacturing purposes without the express written consent of Fuji Electric Co.,Ltd.

- 1.Scope** This specifies Fuji Power MOSFET 2SK3613-01  
**2.Construction** N-Channel enhancement mode power MOSFET  
**3.Applications** for Switching  
**4.Outview** TFP Package Outview See to 12/21 page

**5.Absolute Maximum Ratings at Tc=25°C (unless otherwise specified)**

Description	Symbol	Characteristics	Unit	Remarks
Drain-Source Voltage	V <sub>DS</sub>	250	V	
	V <sub>DSX</sub>	220	V	V <sub>GS</sub> =-30V
Continuous Drain Current	I <sub>D</sub>	± 10	A	
		± 2.2	A	*1 , Ta=25°C
Pulsed Drain Current	I <sub>DP</sub>	± 40	A	
Gate-Source Voltage	V <sub>GS</sub>	± 30	V	
Non-repetitive Avalanche Current	I <sub>AS</sub>	10	A	
Maximum Avalanche Energy	E <sub>AS</sub>	182	mJ	L=3.05mH V <sub>CC</sub> =48V
Maximum Drain-Source dV/dt	dV <sub>DS</sub> /dt	20	kV/μs	V <sub>DS</sub> ≤250V
Peak Diode Recovery dV/dt	dV/dt	5	kV/μs	*2
Maximum Power Dissipation	P <sub>D</sub>	50	W	
		2.4	W	*1 , Ta=25°C
Operating and Storage Temperature range	T <sub>ch</sub>	150	°C	
	T <sub>stg</sub>	-55 to +150	°C	

\*1 Surface mounted on 1000mm<sup>2</sup>,t=1.6mm FR-4 PCB (Drain pad area : 500mm<sup>2</sup>)

\*2 I<sub>F</sub>≤-I<sub>D</sub>,-di/dt=50A/μs,V<sub>CC</sub>≤BV<sub>DSS</sub>,T<sub>ch</sub>≤150°C

**6.Electrical Characteristics at Tc=25°C (unless otherwise specified)**

**Static Ratings**

Description	Symbol	Conditions	min.	typ.	max.	Unit
Drain-Source Breakdown Voltage	BV <sub>DSS</sub>	I <sub>D</sub> =250μA V <sub>GS</sub> =0V	250	-	-	V
Gate Threshold Voltage	V <sub>GS(th)</sub>	I <sub>D</sub> =250μA V <sub>DS</sub> =V <sub>GS</sub>	3.0	-	5.0	V
Zero Gate Voltage Drain Current	I <sub>DSS</sub>	V <sub>DS</sub> =250V V <sub>GS</sub> =0V T <sub>ch</sub> =25°C	-	-	25	μA
		V <sub>DS</sub> =200V V <sub>GS</sub> =0V T <sub>ch</sub> =125°C	-	-	250	
Gate-Source Leakage Current	I <sub>GSS</sub>	V <sub>GS</sub> = ± 30V V <sub>DS</sub> =0V		10	100	nA
Drain-Source On-State Resistance	R <sub>DS(on)</sub>	I <sub>D</sub> =5A V <sub>GS</sub> =10V	-	200	260	mΩ

This material and the information herein is the property of Fuji Electric Co.,Ltd. They shall be neither reproduced, copied, lent, or disclosed in any way whatsoever for the use of any third party nor used for the manufacturing purposes without the express written consent of Fuji Electric Co.,Ltd.

### Dynamic Ratings

Description	Symbol	Conditions	min.	typ.	max.	Unit
Forward Transconductance	$g_{fs}$	$I_D=5A$ $V_{DS}=25V$	5	10	-	S
Input Capacitance	$C_{iss}$	$V_{DS}=75V$	-	785	1178	pF
Output Capacitance	$C_{oss}$	$V_{GS}=0V$	-	88	132	
Reverse Transfer Capacitance	$C_{rss}$	$f=1MHz$	-	4	6	
Turn-On Time	$t_d(on)$	$V_{cc}=48V$	-	12	18	ns
	$t_r$	$V_{GS}=10V$	-	2.7	4.1	
Turn-Off Time	$t_d(off)$	$I_D=5A$	-	22	33	
	$t_f$	$R_{GS}=10\Omega$	-	7.4	11.1	
Total Gate Charge	$Q_G$	$V_{cc}=125V$	-	21	31.5	nC
Gate-Source Charge	$Q_{GS}$	$I_D=10A$	-	8	12	
Gate-Drain Charge	$Q_{GD}$	$V_{GS}=10V$	-	5	7.5	

### Reverse Diode

Description	Symbol	Conditions	min.	typ.	max.	Unit
Avalanche Capability	$I_{AV}$	$L=100\mu H$ $T_{ch}=25^\circ C$ See Fig.1 and Fig.2	10	-	-	A
Diode Forward On-Voltage	$V_{SD}$	$I_F=10A$ $V_{GS}=0V$ $T_{ch}=25^\circ C$	-	1.10	1.65	V
Reverse Recovery Time	$t_{rr}$	$I_F=10A$ $V_{GS}=0V$	-	0.155	-	$\mu s$
Reverse Recovery Charge	$Q_{rr}$	$-di/dt=100A/\mu s$ $T_{ch}=25^\circ C$	-	1.05	-	$\mu C$

### 7.Thermal Resistance

Description	Symbol	min.	typ.	max.	Unit
Channel to Case	$R_{th}(ch-c)$			2.5	$^\circ C/W$
Channel to Ambient	$R_{th}(ch-a)$			87.0	$^\circ C/W$
Channel to Ambient	$R_{th}(ch-a) *1$			52.0	$^\circ C/W$

\*1 Surface mounted on  $1000mm^2$ ,  $t=1.6mm$  FR-4 PCB (Drain pad area :  $500mm^2$ )

Fig.1 Test circuit

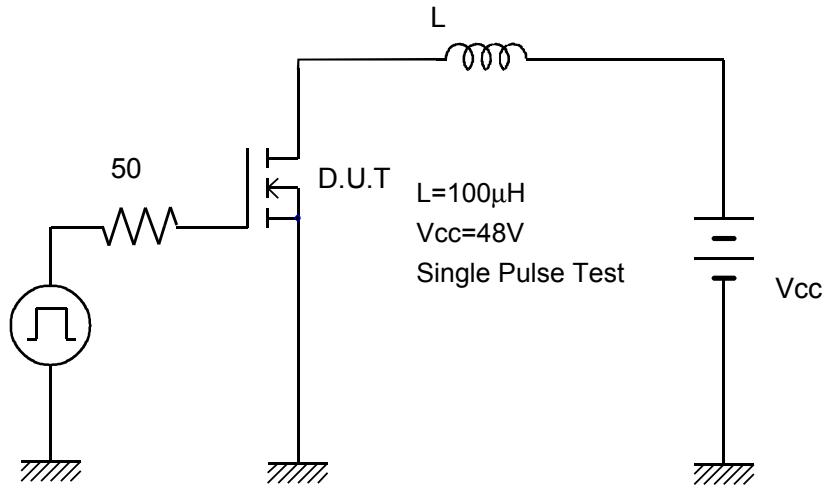
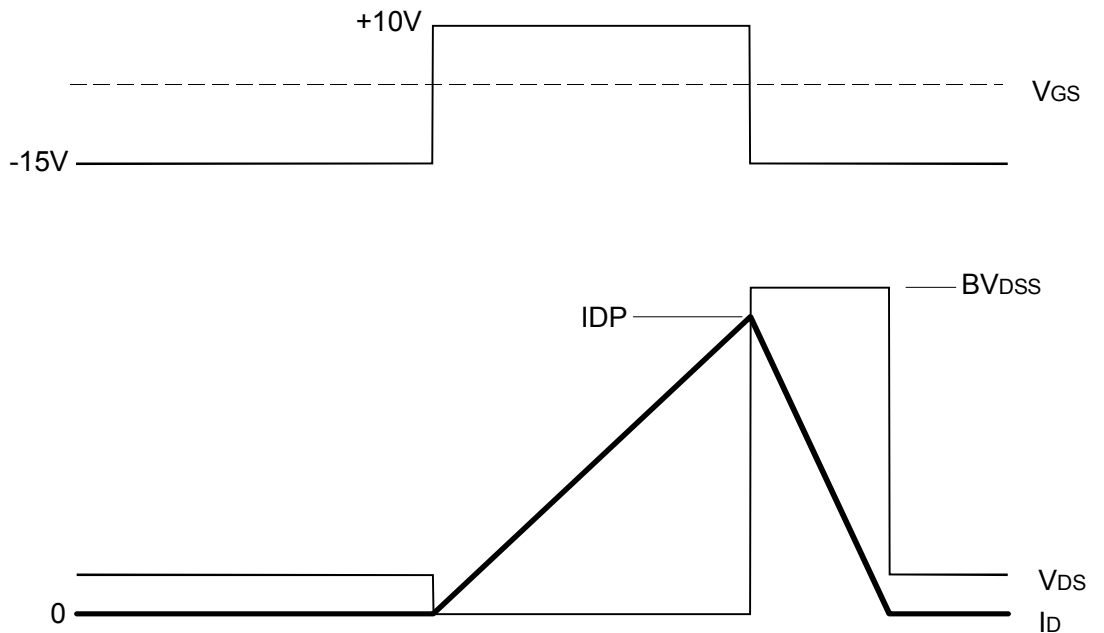

Fig.2 Operating waveforms



This material and the information herein is the property of Fuji Electric Co.,Ltd. They shall be neither reproduced, copied, lent, or disclosed in any way whatsoever for the use of any third party nor used for the manufacturing purposes without the express written consent of Fuji Electric Co.,Ltd.

**8. Reliability test items**

All guaranteed values are under the categories of reliability per non-assembled(only MOSFETs).  
 Each categories under the guaranteed reliability conform to EIAJ ED4701 B101A standards.

( Test items required without fail : Test Method B-121,B-122,B-123,B-131,B-141  
 Humidification treatment (85±2°C,65±5%RH,168±24hr)  
 Heat treatment of soldering (IR-ray Reflow ,235±5°C(240°Cmax.),10±1sec,2 times) )

	Test No.	Test Items	Testing methods and Conditions	Reference Standard EIAJ ED4701	Sampling number	Acceptance number
Mechanical test methods	1	Vibration	frequency : 100Hz to 2kHz Acceleration : 100m/s <sup>2</sup> Sweeping time : 20min./1 cycle 6times for each X,Y&Z directions.	A-121 test code C	15	(0:1)
	2	Shock	Peak amplitude: 15km/s <sup>2</sup> Duration time : 0.5ms 3times for each X,Y&Z directions.	A-122 test code D	15	
	3	Solderability	Solder temp. : 215±5°C Immersion time : 10±0.5sec	A-131A test code B	15	
	4	Resistance to Soldering Heat	Solder temp. : 235±5°C Immersion time : 10±1sec IR-ray Reflowing	A-133A test code 1-A	15	

This material and the information herein is the property of Fuji Electric Co.,Ltd. They shall be neither reproduced, copied, lent, or disclosed in any way whatsoever for the use of any third party nor used for the manufacturing purposes without the express written consent of Fuji Electric Co.,Ltd.

This material and the information herein is the property of Fuji Electric Co.,Ltd. They shall be neither reproduced, copied, lent, or disclosed in any way whatsoever for the use of any third party nor used for the manufacturing purposes without the express written consent of Fuji Electric Co.,Ltd.

	Test No.	Test Items	Testing methods and Conditions	Reference Standard EIAJ ED4701	Sampling number	Acceptance number
Climatic test methods	1	High Temp. Storage	Temperature : 150+0/-5°C Test duration : 1000hr	B-111A	22	(0:1)
	2	Low Temp. Storage	Temperature : -55+5/-0°C Test duration : 1000hr	B-112A	22	
	3	Temperature Humidity Storage	Temperature : 85±2°C Relative humidity : 85±5% Test duration : 1000hr	B-121A test code C	22	
	4	Temperature Humidity BIAS	Temperature : 85±2°C Relative humidity : 85±5% Bias Voltage : $V_{DS(max)} * 0.8$ Test duration : 1000hr	B-122A test code C	22	
	5	Unsaturated Pressurized Vapor	Temperature : 130±2°C Relative humidity : 85±5% Vapor pressure : 230kPa Test duration : 96hr	B-123A test code C	22	
	6	Temperature Cycle	High temp.side : 150±5°C Low temp.side : -55±5°C Duration time : HT 30min,LT 30min Number of cycles : 100cycles	B-131A test code A	22	
	7	Thermal Shock	Fluid : pure water(running water) High temp.side : 100+0/-5°C Low temp.side : 0+5/-0°C Duration time : HT 5min,LT 5min Number of cycles : 100cycles	B-141A test code A	22	
Test for FET	1	Intermittent Operating Life	$T_a=25±5°C$ $\Delta T_c=90\text{degree}$ $T_{ch} \leq T_{ch(max.)}$ Test duration : 3000 cycle	D-322	22	(0:1)
	2	HTRB (Gate-source)	Temperature : 150+0/-5°C Bias Voltage : $V_{GS(max)}$ Test duration : 1000hr	D-323	22	
	3	HTRB (Drain-Source)	Temperature : 150+0/-5°C Bias Voltage : $V_{DS(max)}$ Test duration : 1000hr	D-323	22	

Failure Criteria

	Item	Symbols	Failure Criteria		Unit
			Lower Limit	Upper Limit	
Electrical Characteristics	Breakdown Voltage	BVDSS	LSL * 0.8	-----	V
	Zero gate Voltage Drain-Source Current	IDSS	-----	USL * 2	A
	Gate-Source Leakage Current	IGSS	-----	USL * 2	A
	Gate Threshold Voltage	VGS(th)	LSL * 0.8	USL * 1.2	V
	Drain-Source on-state Resistance	RDS(on)	-----	USL * 1.2	$\Omega$
	Forward Transconductance	gfs	LSL * 0.8	-----	S
	Diode forward on-Voltage	VSD	-----	USL * 1.2	V
Outview	Marking				
	Soldering and other damages	-----	With eyes or Microscope		-----

\* LSL : Lower Specification Limit

\* USL : Upper Specification Limit

\* Before any of electrical characteristics measure, all testing related to the humidity have conducted after drying the package surface for more than an hour at 150°C.

**Fuji Electric Co.,Ltd.**

DWG NO.

**MS5F5124**

7 / 21

This material and the information herein is the property of Fuji Electric Co., Ltd. They shall be neither reproduced, copied, lent, or disclosed in any way whatsoever for the use of any third party nor used for the manufacturing purposes without the express written consent of Fuji Electric Co., Ltd.

## 9 Warning

9.1. Although Fuji Electric is enhancing product quality and reliability, a small percentage of semiconductor products may become faulty. When using Fuji Electric semiconductor products in your equipment, you are requested to take adequate safety measures to prevent the equipment from causing a physical injury, fire, or other problem if any of the products become faulty. It is recommended to make your design fail-safe, flame retardant, and free of malfunction.

9.2. The products introduced in this Specification are intended for use in the following electronic and electrical equipment which has normal reliability requirements.

- Computers/OA equipments      • Communications equipment (Terminal devices)
- Measurement equipments      • Machine tools                      • AV equipments
- Electrical home appliances      • Personal equipments              • Industrial robots                      etc...

9.3. If you need to use a product in this Specification for equipment requiring higher reliability than normal, such as for the equipment listed below, it is imperative to contact Fuji Electric to obtain prior approval. When using these products for such equipment, take adequate measures such as a backup system to prevent the equipment from malfunctioning even if a Fuji's product incorporated in the equipment becomes faulty.

- Transportation equipment (Automotives, Locomotives and ships etc...)
- Backbone network equipment                      • Traffic-signal control equipment
- Gas alarm, Leakage gas auto breaker
- Burglar alarm, Fire alarm, Emergency equipments etc...

9.4. Don't use products in this Specification for the equipment requiring strict reliability such as (without limitation)

- Aerospace equipment                      • Aeronautic equipment                      • nuclear control equipment
- Medical equipment                      • Submarine repeater equipment

## 10. General Notice

### 10.1. Preventing ESD Damage

Although the gate oxide of Fuji Power MOSFETs is much higher ruggedness to ESD damage than small-Signal MOSFETs and CMOS ICs, careful handling of any MOS devices are an important consideration.

- 1) When handling MOSFETs, hold them by the case (package) and don't touch the leads and terminals.
- 2) It is recommended that any handling of MOSFETs is done while used electrically conductive floor and tablemats that are grounded.
- 3) Before touching a MOSFETs terminal, discharge any static electricity from your body and clothes by grounding out through a high impedance resistor (about 1MΩ)
- 4) When soldering, in order to protect the MOSFETs from static electricity, ground the soldering iron or soldering bath through a low impedance resistor.



This material and the information herein is the property of Fuji Electric Co., Ltd. They shall be neither reproduced, copied, lent, or disclosed in any way whatsoever for the use of any third party nor used for the manufacturing purposes without the express written consent of Fuji Electric Co., Ltd.

#### 10.2. Short mode failure / Open mode failure

The MOSFETs may be in the risk of having short mode failure or open mode failure when the applied over voltage, over current or over temperature each specified maximum rating. It is recommended to use the fail-safe equipment or circuit from such possible failures.

#### 10.3. An Electric shock / A Skin burn

You may be in risk for an Electric shock or a Skin burn for directly touching to the leads or package of the MOSFETs while turning on electricity or operating.

#### 10.4. Smoke / Fire

Fuji MOSFETs are made of incombustibility material. However, a failure of the MOSFETs may emit smoke or fire. Also, operating the MOSFETs near any flammable place or material may risk the MOSFETs to emit smoke or fire due to the MOSFETs reach high temperature while operated.

#### 10.5. Corrosion / Erosion

Avoid use or storage of the MOSFETs under the higher humidity, corrosive gases. It will lead the device to corrode and possibly cause the device to fail.

#### 10.6. Radiation field

Don't use of the device under the radiation field since the device is not designed for radiation proofing.

### **11. Notes for Design**

11.1. You must design the MOSFETs to be operated within specified maximum ratings (Voltage, Current, Temperature etc...) which are imperative to prevent possible failure or destruction of the device.

11.2. We recommend to use the protection equipment or safety equipment such as fuse, breaker to prevent the fire or damage in case of unexpected accident may have occurred.

11.3. You must design the MOSFETs within its reliability and lifetime in certain the environment or condition. There is a risk that MOSFETs breakdown earlier than the target lifetime of the your products when MOSFETs was used in the reliability condition excessively. Especially avoid use of the MOSFETs under the higher humidity, corrosive gases.

11.4. We recommend to consider for the temperature rise not only for the Channel but also for the Leads if it designed to large current operation to the MOSFETs.

11.5. We only guarantee the non-repetitive Avalanche capability and not for the continuous, repetitive Avalanche capability which can be assumed as abnormal condition. Please note the device may be destructed from the Avalanche over the specified maximum rating.

## 12. Note on implementation

### 12.1. Soldering

Soldering involves temperatures which exceed the device storage temperature rating. To avoid device damage and to ensure reliability, the following guidelines from the quality assurance standard must be observed.

#### 1) Solder temperature and duration (Through-Hole Package)

Solder temperature	Duration
260±5 °C	10±1 seconds
350±10 °C	3.5±0.5 seconds

2) The device should not be soldered closer than 1mm from the package. (\* through-hole package)

3) When flow soldered, care must be taken to avoid immersing the package in the solder-bath.

12.2. Please see to the following the Torque reference when mounting the device to heat sink. Excess torque applied to the mounting screw causes damage to the device and weak torque will increase the thermal resistance. Both of these conditions may lead the device to be destructed.

Table 1 : Recommended tightening torques.

Package style	Screw	Recommended tightening torques
TO-220 TO-220F	M3	30 – 50 Ncm
TO-3P TO-3PF TO-247	M3	40 – 60 Ncm
TO-3PL	M3	60 –80 Ncm

12.3. If the heat sink with coarse finish is used, increase in thermal resistance and concentrated force to a point may cause the MOSFETs to be destructed. We recommend in such condition to process the surface of heat sink within ±50µm and use of thermal compound to optimize its efficiency of heat radiation. Moreover, it is important to evenly apply the compound and eliminate any air voids. A simple method is to apply a dot of compound of the appropriate quantity to the center of the case just below the chip mount.

This material and the information herein is the property of Fuji Electric Co.,Ltd. They shall be neither reproduced, copied, lent, or disclosed in any way whatsoever for the use of any third party nor used for the manufacturing purposes without the express written consent of Fuji Electric Co.,Ltd.

### **13. Notes for Storage**

- 13.1. The MOSFETs should be stored at a standard temperature of 5 to 35 °C and humidity of 45 to 75%RH. If the storage area is very dry, a humidifier may be required. In such a case, use only deionized water or boiled water, since the chlorine in tap water may corrode the leads.
- 13.2. Avoid exposure to corrosive gases and dust.
- 13.3. Rapid temperature changes may cause condensation on the MOSFETs surface. Therefore, store the MOSFETs in a place with few temperature changes.
- 13.4. While in storage, it is important that nothing be loaded on top of the MOSFETs, since this may cause excessive external force on the case.
- 13.5. Store MOSFETs with unprocessed lead terminals. Rust may cause presoldered connections to go bad during later processing.
- 13.6. Use only antistatic containers or shipping bag for storing MOSFETs.

### **14. Additional points**

If you have any question about any portion in this Specification, ask Fuji Electric or its sales agents before using the product. Neither Fuji nor its agents shall be liable for any injury caused by any use of the products not in accordance with instructions set forth herein.

# FUJI POWER MOS FET

## OUT VIEW

### 外形寸法図

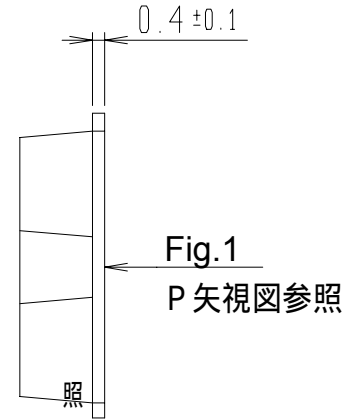
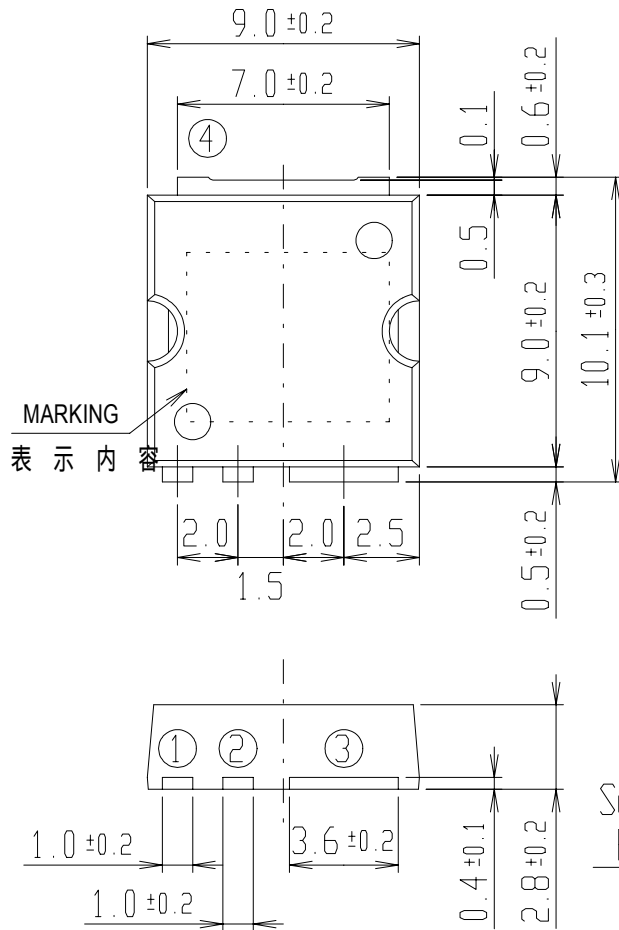
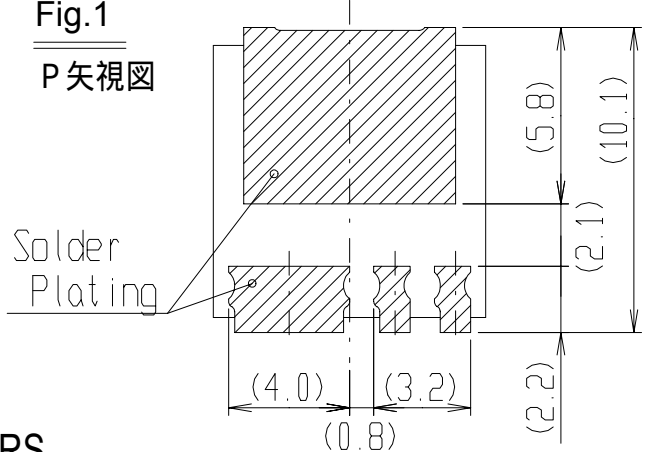

Fig.1  
P 矢視図



DIMENSIONS ARE IN MILLIMETERS.

Note:1. Dimension shown in ( ) is reference values.

注) 1. ( ) 内寸法は参考値とする。

## MARKING

表示内容

Trademark

商標

Special specification for customer

特殊品記号

Lot No.

ロットNo.

Type name

形名

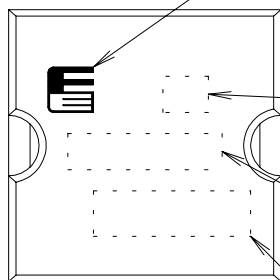

## CONNECTION

結線図

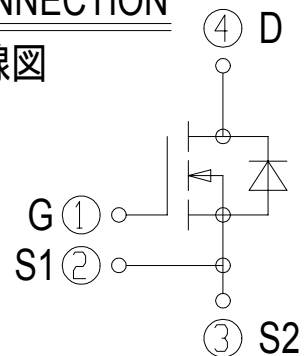

This material and the information herein is the property of Fuji Electric Co., Ltd. They shall be neither reproduced, copied, lent, or disclosed in any way whatsoever for the use of any third party nor used for the manufacturing purposes without the express written consent of Fuji Electric Co., Ltd.

Allowable Power Dissipation

$PD=f(T_c)$

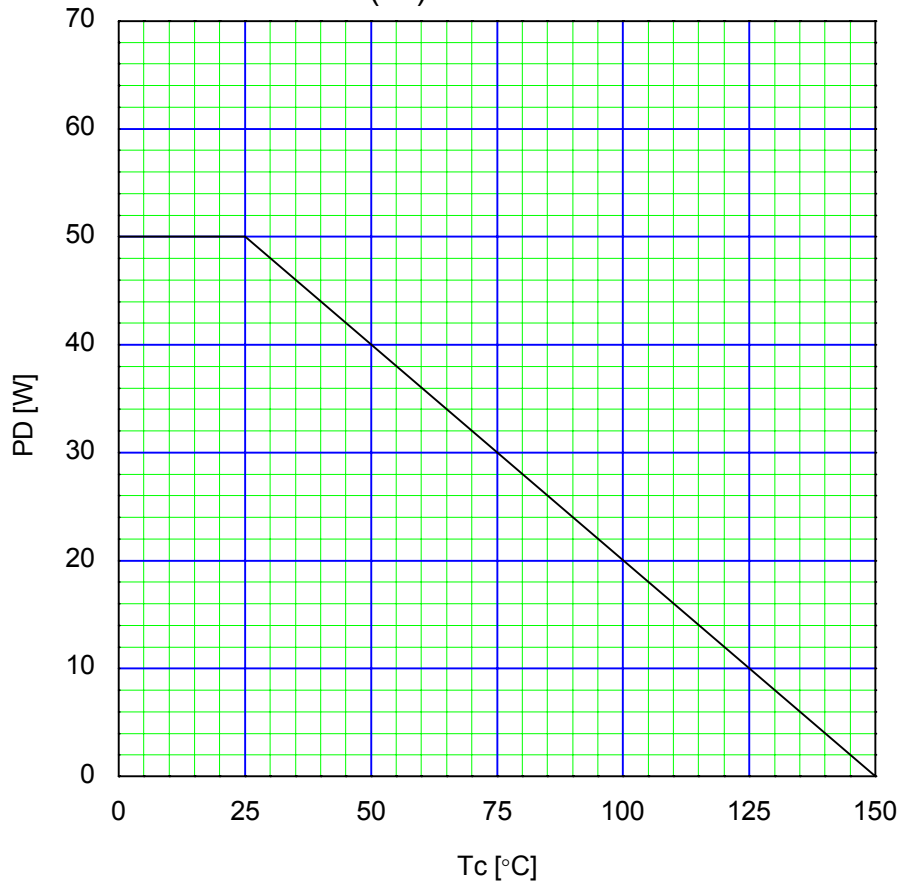

Allowable Power Dissipation

$PD=f(T_c)$

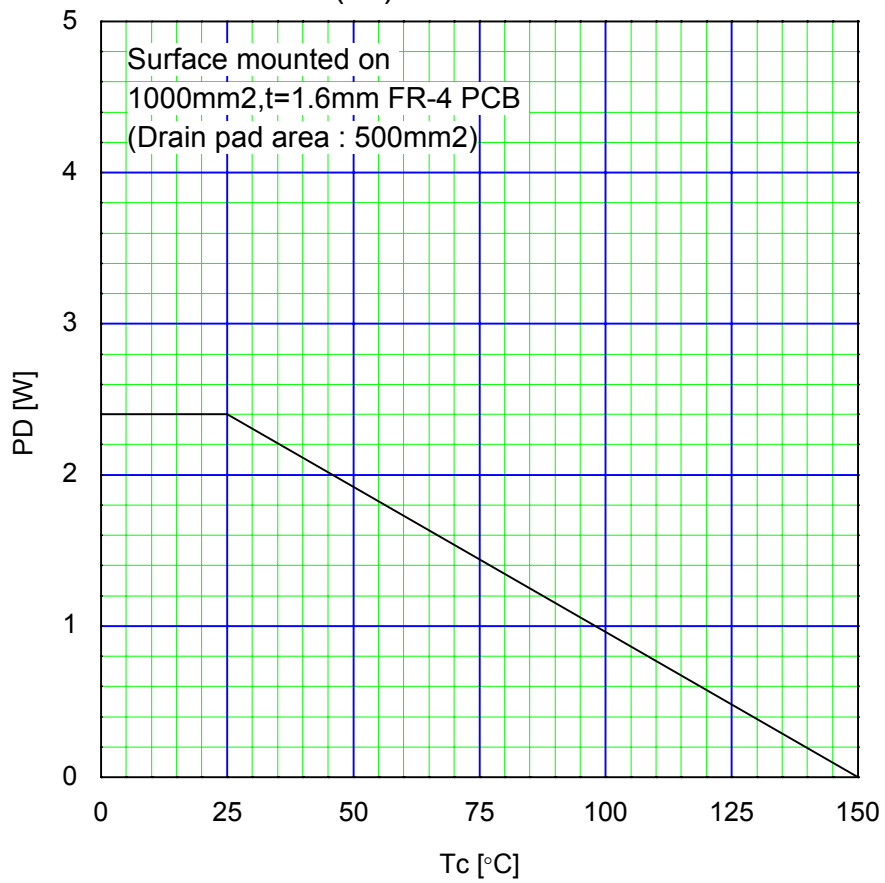

This material and the information herein is the property of Fuji Electric Co.,Ltd. They shall be neither reproduced, copied, lent, or disclosed in any way whatsoever for the use of any third party nor used for the manufacturing purposes without the express written consent of Fuji Electric Co.,Ltd.

This material and the information herein is the property of Fuji Electric Co.,Ltd. They shall be neither reproduced, copied, lent, or disclosed in any way whatsoever for the use of any third party nor used for the manufacturing purposes without the express written consent of Fuji Electric Co.,Ltd.

Typical Output Characteristics  
 $I_D=f(V_{DS}):80\ \mu\text{s}$  pulse test,  $T_{ch}=25^\circ\text{C}$

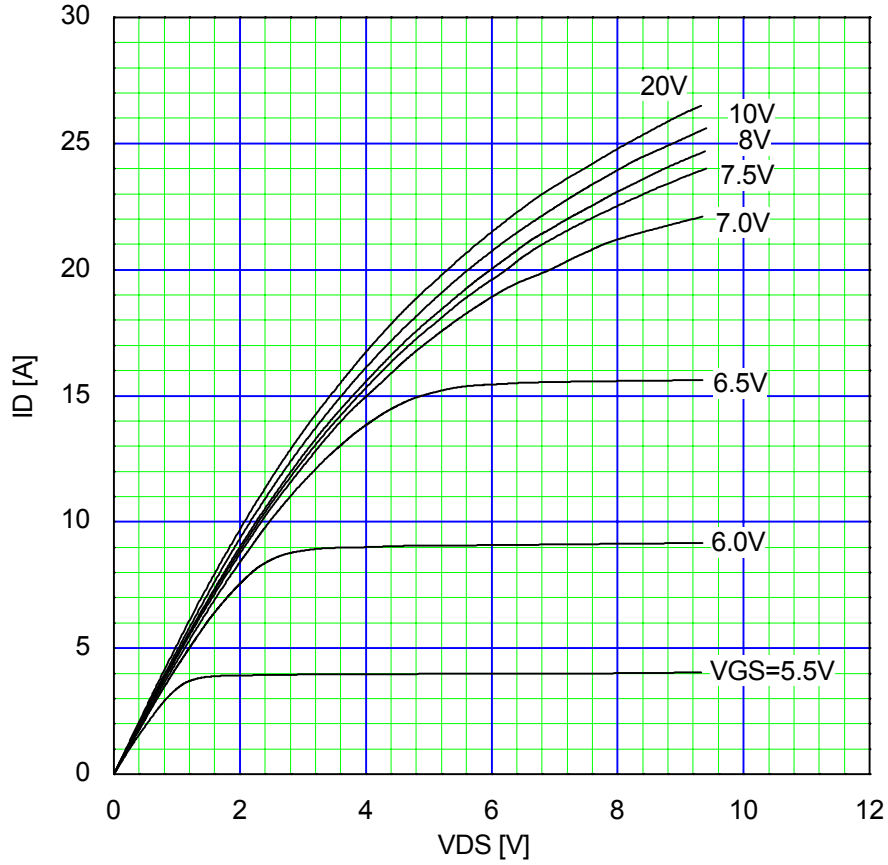

Typical Transfer Characteristic  
 $I_D=f(V_{GS}):80\ \mu\text{s}$  pulse test,  $V_{DS}=25\text{V}$ ,  $T_{ch}=25^\circ\text{C}$

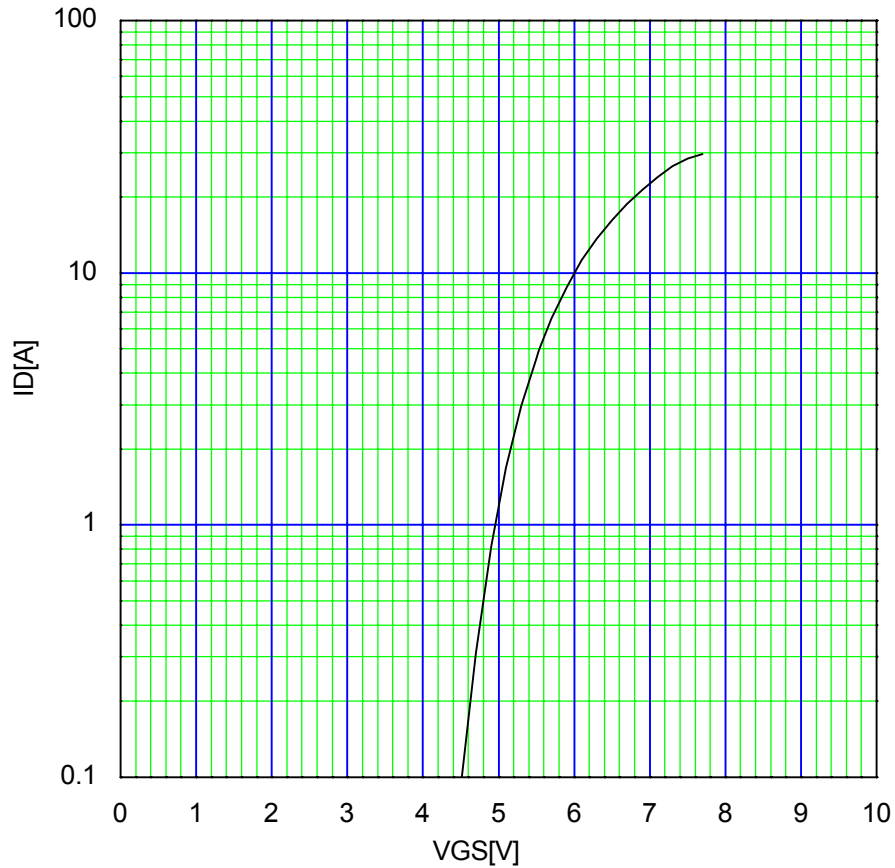

This material and the information herein is the property of Fuji Electric Co.,Ltd. They shall be neither reproduced, copied, lent, or disclosed in any way whatsoever for the use of any third party nor used for the manufacturing purposes without the express written consent of Fuji Electric Co.,Ltd.

Typical Transconductance  
 $g_{fs}=f(I_D):80\ \mu\text{s}\ \text{pulse}\ \text{test}, V_{DS}=25\text{V}, T_{ch}=25^\circ\text{C}$

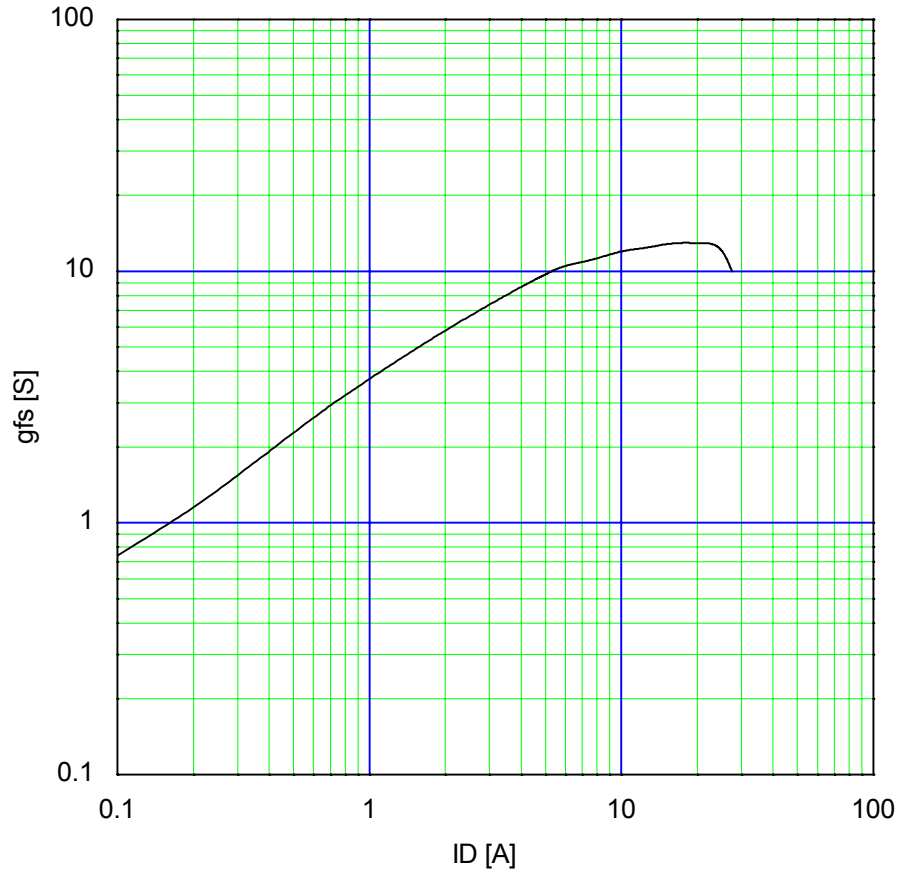

Typical Drain-Source on-state Resistance  
 $R_{DS(on)}=f(I_D):80\ \mu\text{s}\ \text{pulse}\ \text{test}, T_{ch}=25^\circ\text{C}$

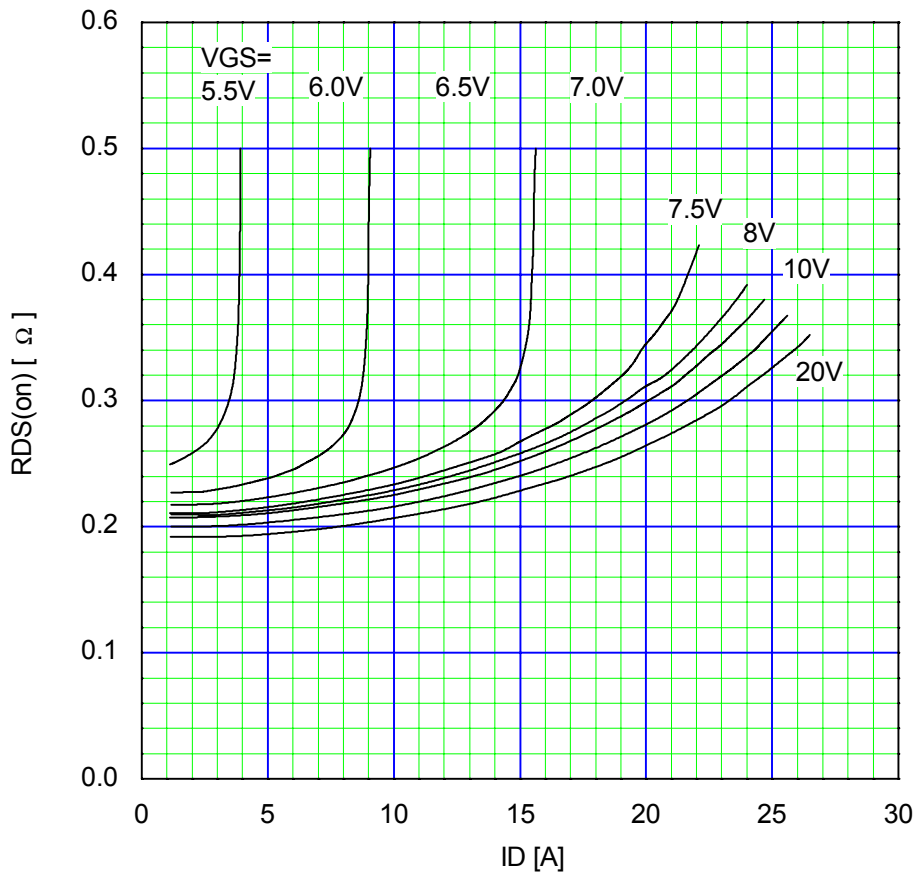

This material and the information herein is the property of Fuji Electric Co.,Ltd. They shall be neither reproduced, copied, lent, or disclosed in any way whatsoever for the use of any third party nor used for the manufacturing purposes without the express written consent of Fuji Electric Co.,Ltd.

### Drain-Source On-state Resistance $R_{DS(on)}=f(T_{ch}):I_D=5A,V_{GS}=10V$

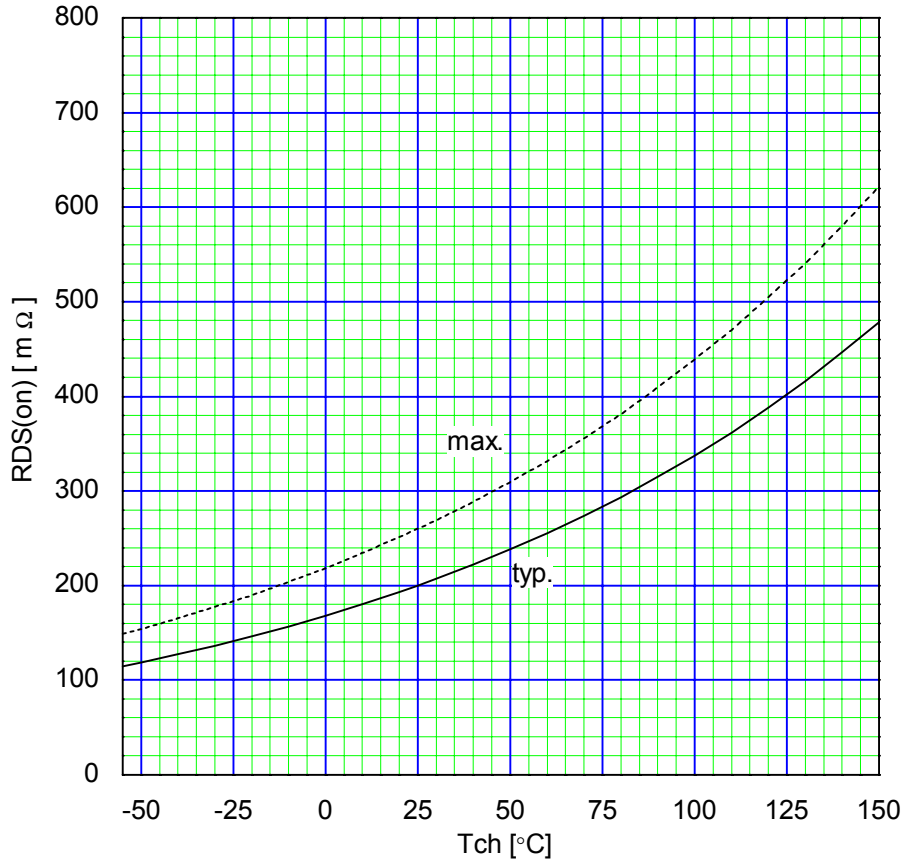

### Gate Threshold Voltage vs. $T_{ch}$ $V_{GS(th)}=f(T_{ch}):V_{DS}=V_{GS},I_D=250\mu A$

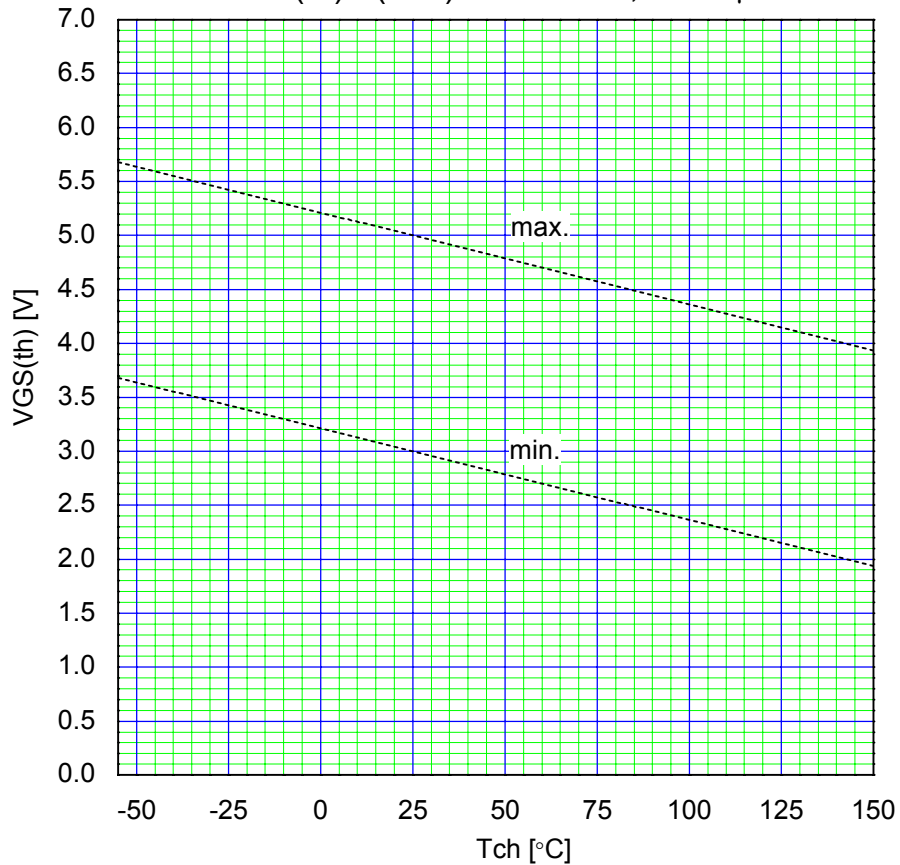



This material and the information herein is the property of Fuji Electric Co.,Ltd. They shall be neither reproduced, copied, lent, or disclosed in any way whatsoever for the use of any third party nor used for the manufacturing purposes without the express written consent of Fuji Electric Co.,Ltd.

### Typical Gate Charge Characteristics $V_{GS}=f(Q_g): I_D=10A, T_{ch}=25^\circ C$

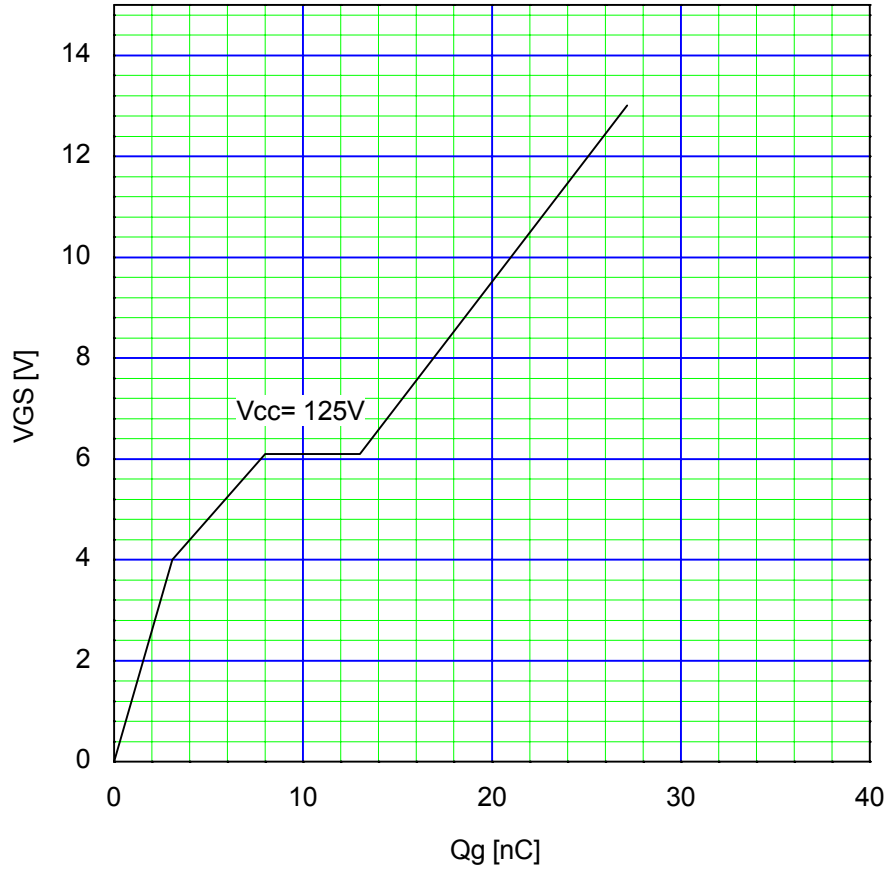

### Typical Capacitance $C=f(V_{DS}): V_{GS}=0V, f=1MHz$

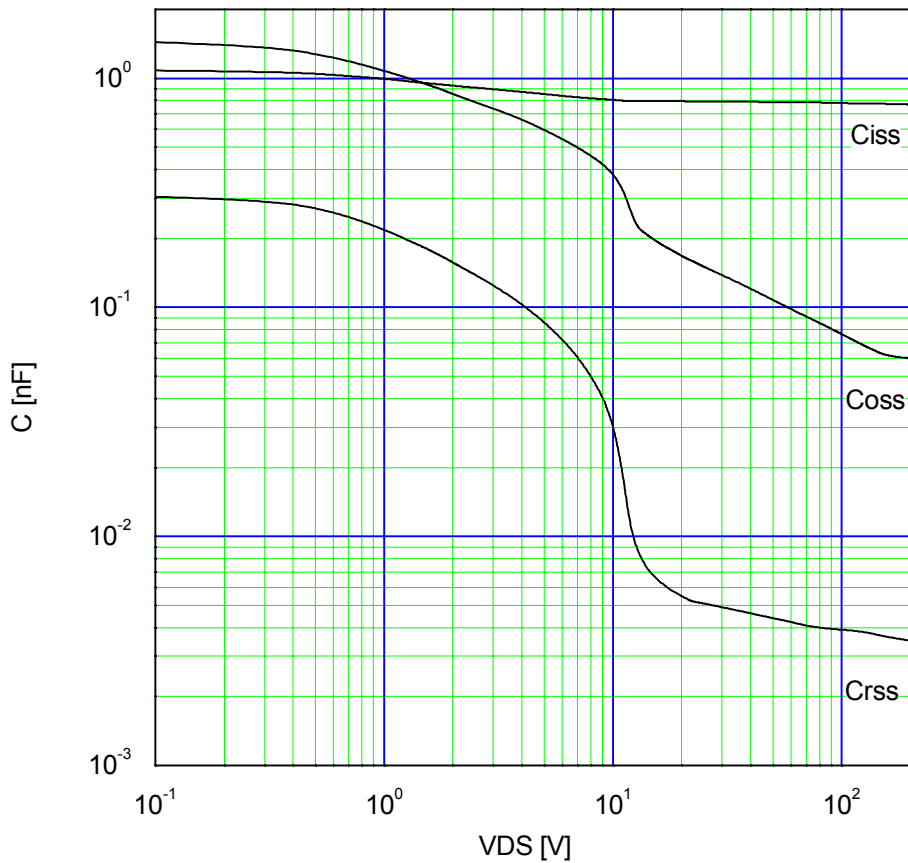

This material and the information herein is the property of Fuji Electric Co.,Ltd. They shall be neither reproduced, copied, lent, or disclosed in any way whatsoever for the use of any third party nor used for the manufacturing purposes without the express written consent of Fuji Electric Co.,Ltd.

Typical Forward Characteristics of Reverse Diode  
 $I_F=f(V_{SD}):80\ \mu\text{s}\ \text{pulse}\ \text{test},T_{ch}=25^\circ\text{C}$

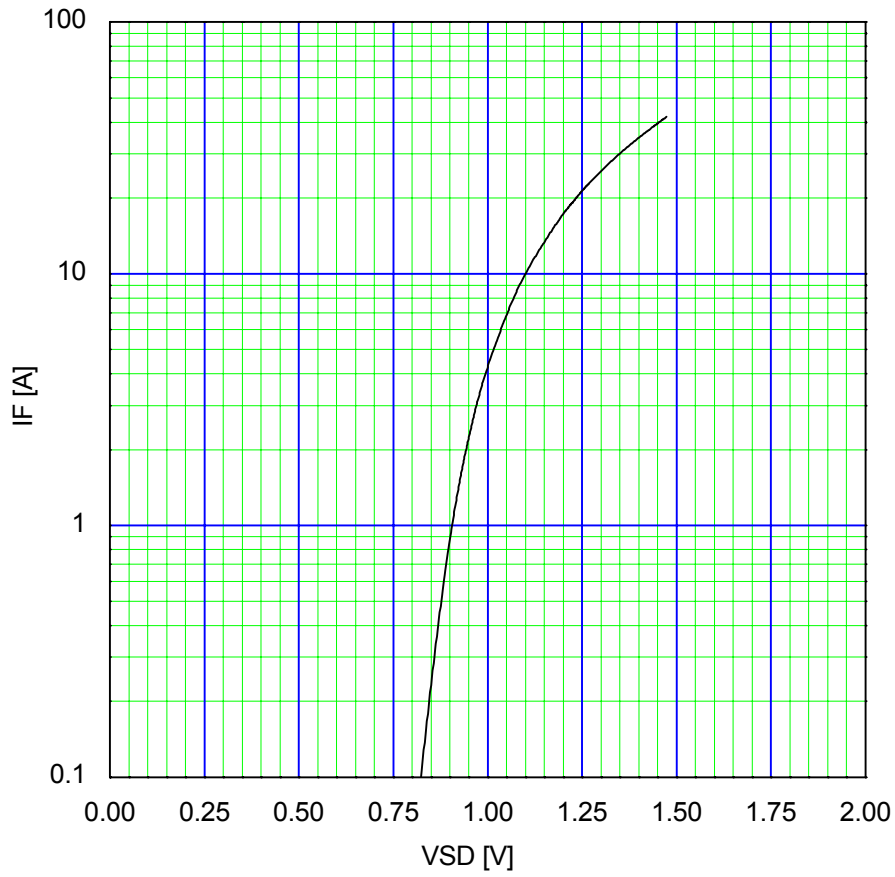

Typical Switching Characteristics vs.  $I_D$   
 $t=f(I_D):V_{cc}=48\text{V},V_{GS}=10\text{V},R_G=10\ \Omega$

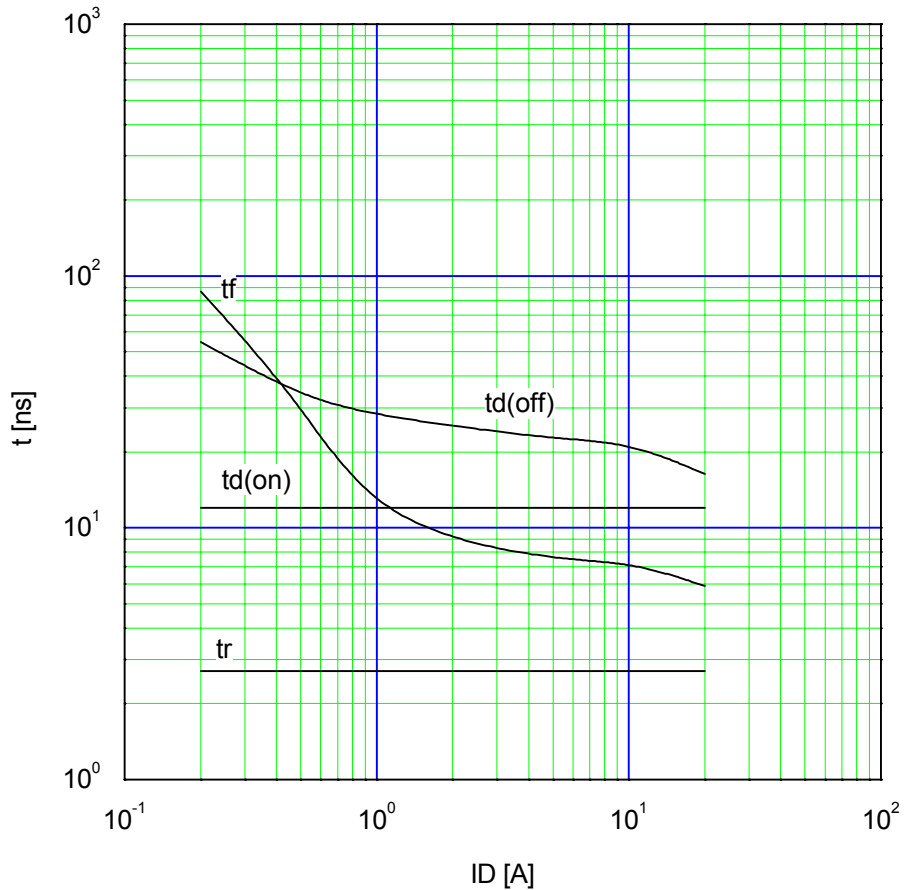

This material and the information herein is the property of Fuji Electric Co.,Ltd. They shall be neither reproduced, copied, lent, or disclosed in any way whatsoever for the use of any third party nor used for the manufacturing purposes without the express written consent of Fuji Electric Co.,Ltd.

Maximum Avalanche Current vs. starting Tch  
 $I(AV)=f(\text{starting Tch}):V_{CC}=48V$

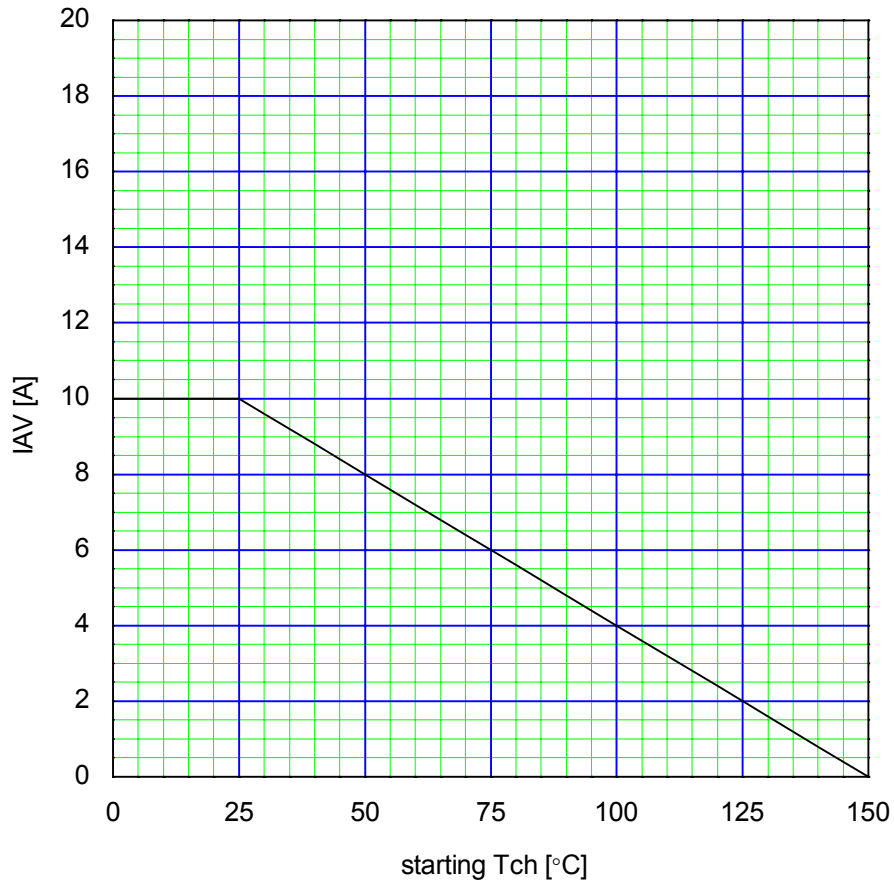

Maximum Avalanche Energy vs. starting Tch  
 $E(AV)=f(\text{starting Tch}):V_{CC}=48V, I(AV)\leq 10A$

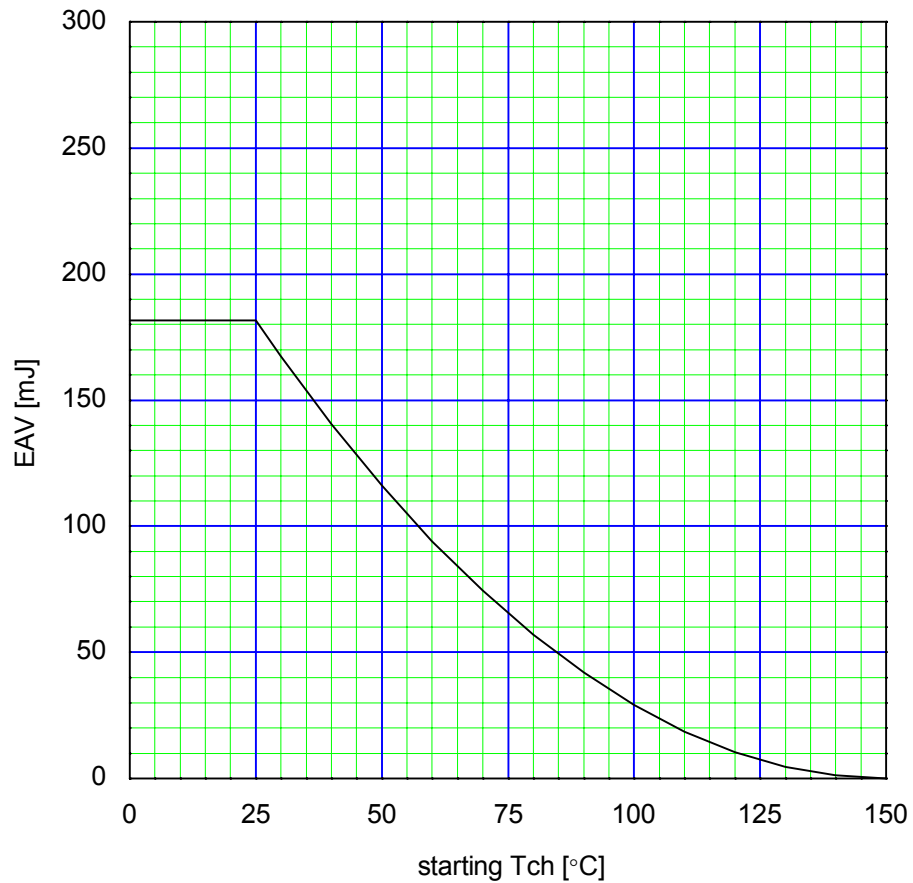

This material and the information herein is the property of Fuji Electric Co.,Ltd. They shall be neither reproduced, copied, lent, or disclosed in any way whatsoever for the use of any third party nor used for the manufacturing purposes without the express written consent of Fuji Electric Co.,Ltd.

### Maximum Avalanche Current Pulsewidth

$$I_{AV} = f(t_{AV}): \text{starting } T_{ch} = 25^{\circ}\text{C}, V_{cc} = 48\text{V}$$

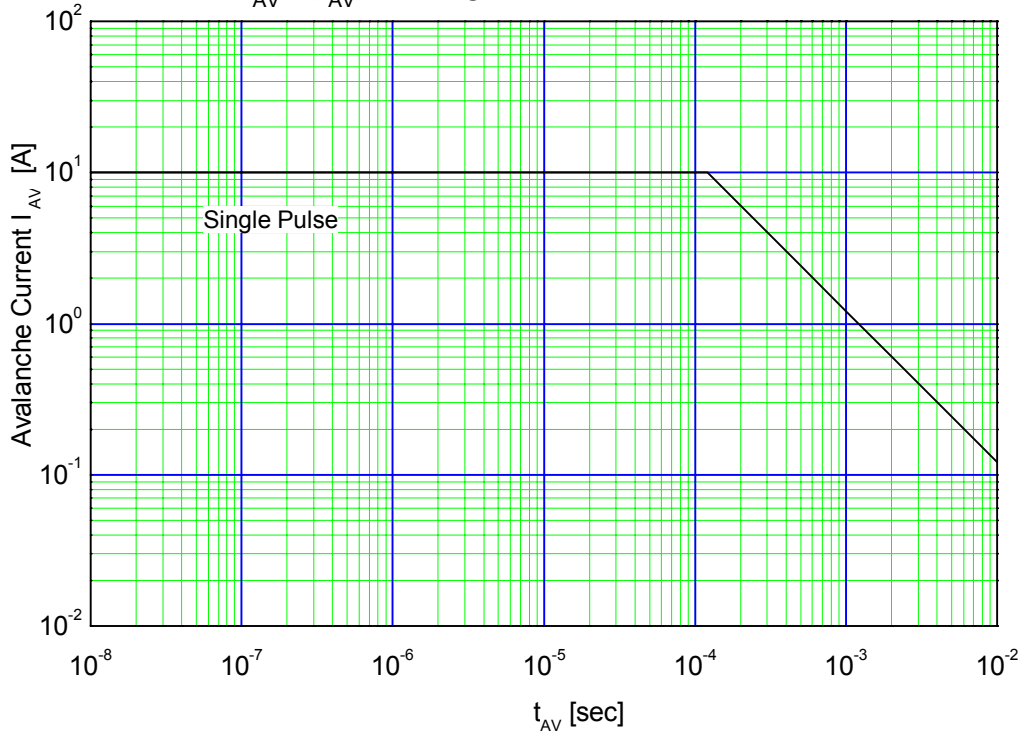

### Transient Thermal Impedance

$$Z_{th}(ch-c) = f(t): \text{Duty} = 0$$

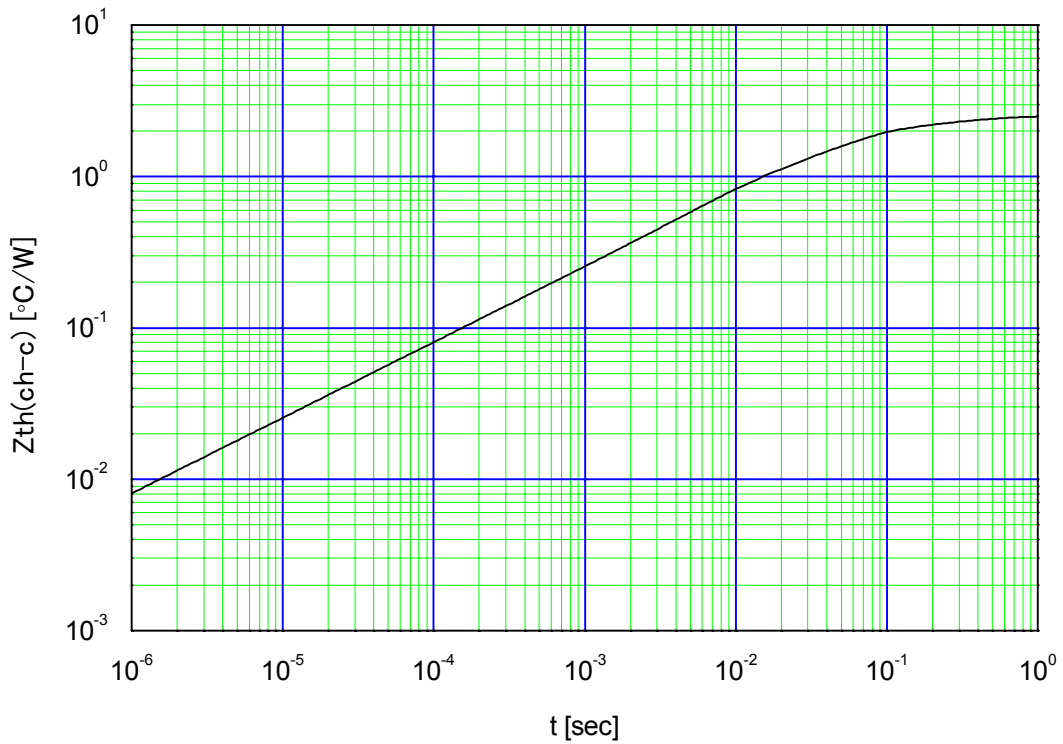

This material and the information herein is the property of Fuji Electric Co.,Ltd. They shall be neither reproduced, copied, lent, or disclosed in any way whatsoever for the use of any third party nor used for the manufacturing purposes without the express written consent of Fuji Electric Co.,Ltd.

### Thermal Resistance vs. Drain Pad area t=1.6mm FR-4 PCB

