

2SK3219-01MR

FUJI POWER MOS-FET

N-CHANNEL SILICON POWER MOS-FET

■ Features

- High speed switching
- Low on-resistance
- No secondary breakdown
- Low driving power
- Avalanche-proof

■ Applications

- Switching regulators
- UPS (Uninterruptible Power Supply)
- DC-DC converters

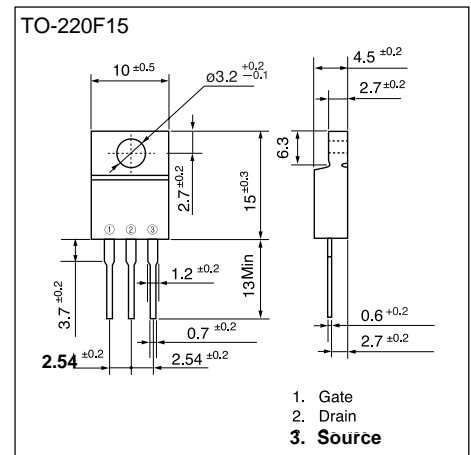

■ Maximum ratings and characteristic Absolute maximum ratings

● (T_c=25°C unless otherwise specified)

Item	Symbol	Rating	Unit	
Drain-source voltage	V _{DS}	150	V	
Continuous drain current	I _D	±40	A	
Pulsed drain current	I _{D(puls)}	±160	A	
Gate-source voltage	V _{GS}	±30	V	
Maximum Avalanche Energy	E _{AV*1}	387	mJ	
Max. power dissipation	T _a =25°C	P _D	2.0	W
	T _c =25°C	P _D	70	W
Operating and storage temperature range	T _{ch}	+150	°C	
	T _{stg}	-55 to +150	°C	

*1 L=420μH, V_{cc}=24V

■ Equivalent circuit schematic

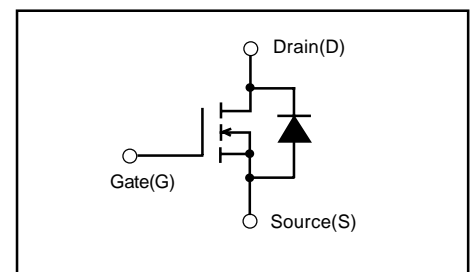

● Electrical characteristics (T_c =25°C unless otherwise specified)

Item	Symbol	Test Conditions	Min.	Typ.	Max.	Units
Drain-source breakdown voltage	V _{(BR)DSS}	I _D =1mA V _{GS} =0V	150			V
Gate threshold voltage	V _{GS(th)}	I _D =1mA V _{DS} =V _{GS}	2.5	3.0	3.5	V
Zero gate voltage drain current	I _{DSS}	V _{DS} =150V V _{GS} =0V	T _{ch} =25°C	1	100	μA
			T _{ch} =125°C	0.1	0.5	mA
Gate-source leakage current	I _{GSS}	V _{GS} =±30V V _{DS} =0V		10	100	nA
Drain-source on-state resistance	R _{DS(on)}	I _D =20A V _{GS} =10V		37	43	mΩ
Forward transconductance	g _{fs}	I _D =20A V _{DS} =25V	12.5	25.0		S
Input capacitance	C _{iss}	V _{DS} =25V		2650	3980	pF
Output capacitance	C _{oss}	V _{GS} =0V		550	830	
Reverse transfer capacitance	C _{rss}	f=1MHz		240	360	
Turn-on time t _{on}	t _{d(on)}	V _{CC} =48V I _D =40A V _{GS} =10V		21	32	ns
			t _r		95	
Turn-off time t _{off}	t _{d(off)}	R _{GS} =10Ω		115	173	
			t _f		60	
Avalanche capability	I _{AV}	L=100μH T _{ch} =25°C	40			A
Diode forward on-voltage	V _{SD}	I _F =40A V _{GS} =0V T _{ch} =25°C		0.97	1.46	V
Reverse recovery time	t _{rr}	I _F =40A V _{GS} =0V		180		ns
Reverse recovery charge	Q _{rr}	-di/dt=100A/μs T _{ch} =25°C		1.30		μC

● Thermal characteristics

Item	Symbol	Test Conditions	Min.	Typ.	Max.	Units
Thermal resistance	R _{th(ch-c)}	channel to case			1.79	°C/W
	R _{th(ch-a)}	channel to ambient			62.5	°C/W

Characteristics

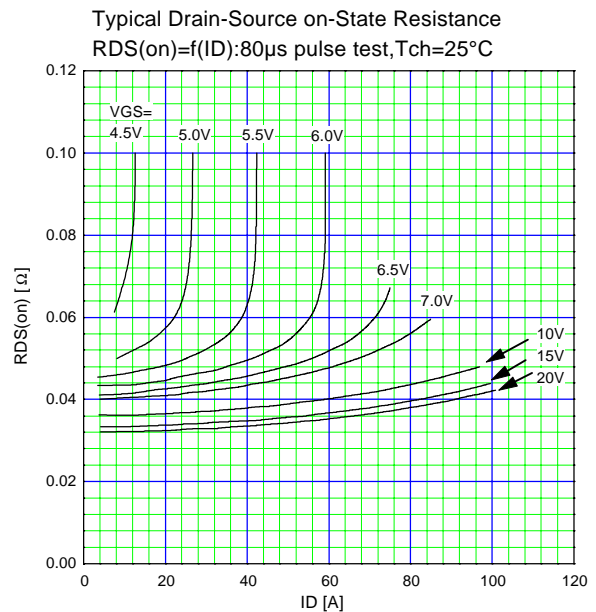
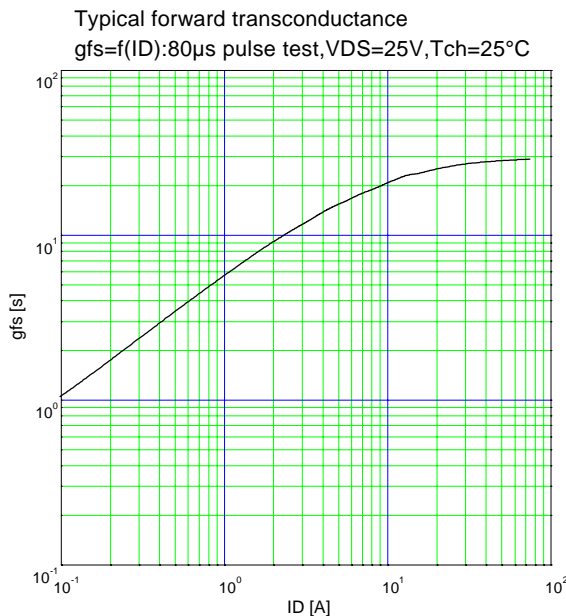
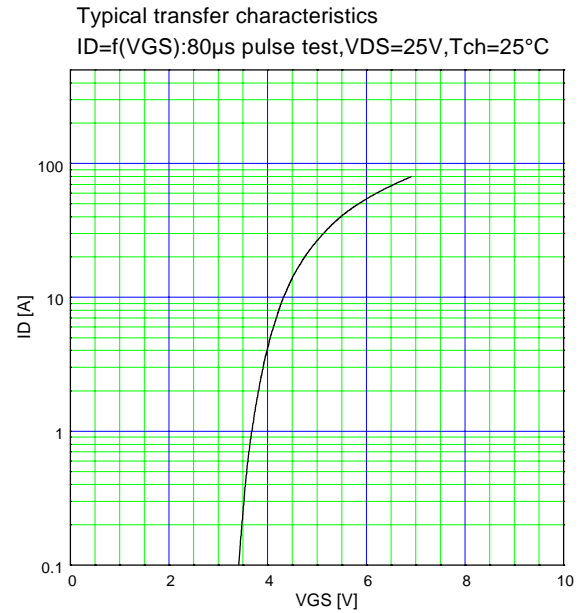
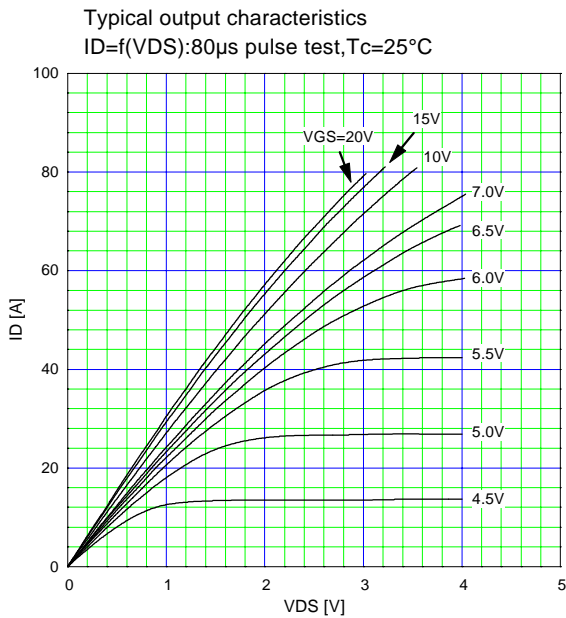
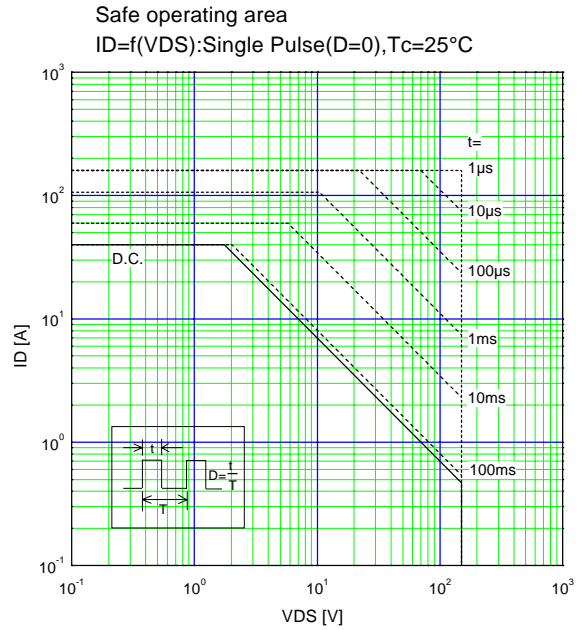
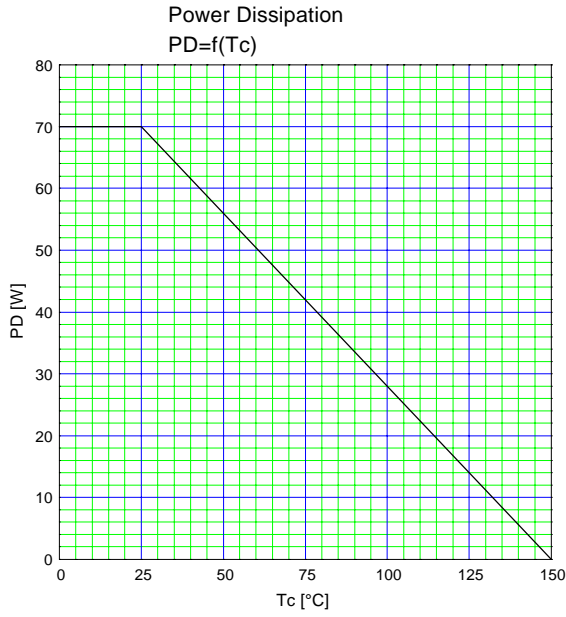

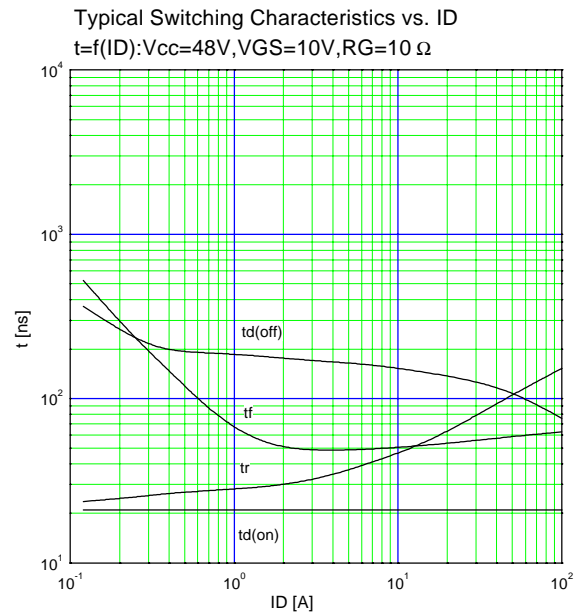
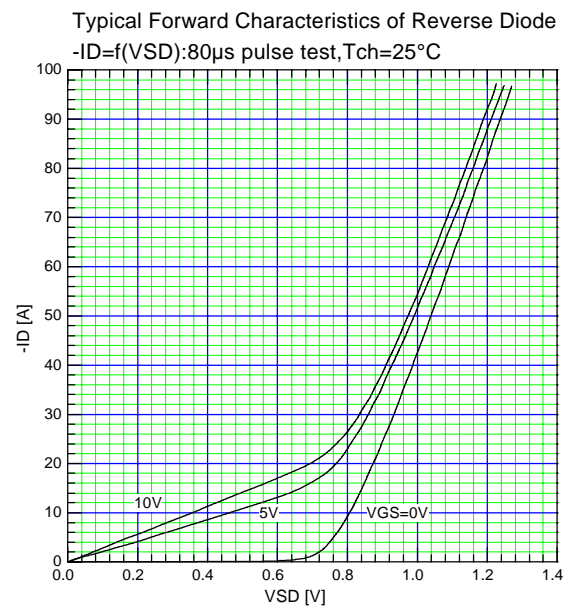
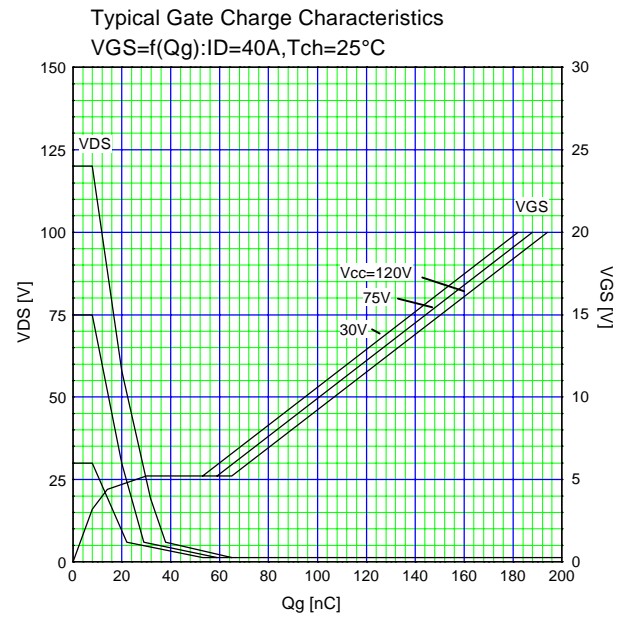
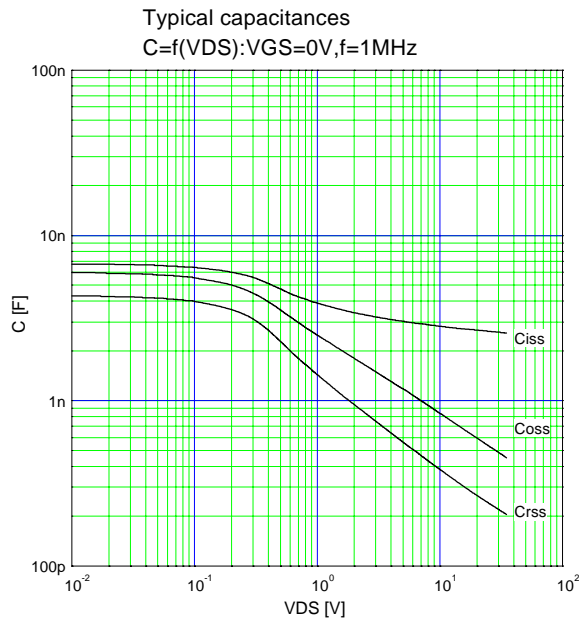
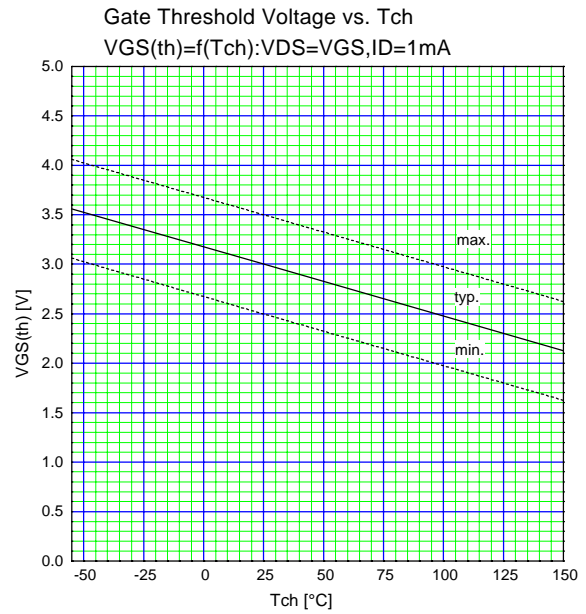
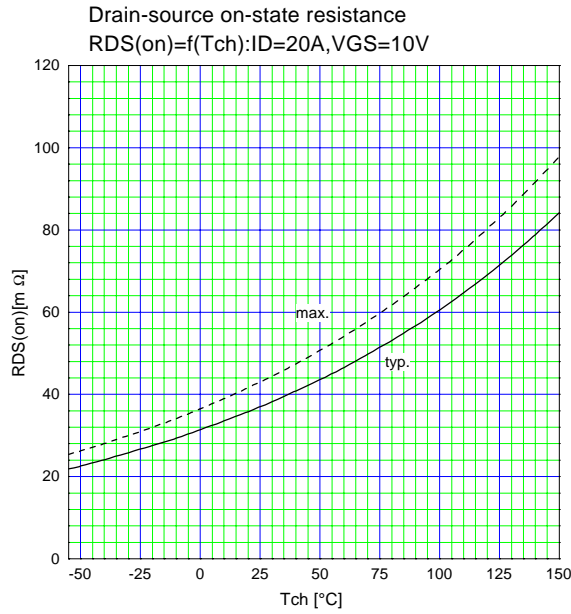

Maximum Avalanche Current vs. starting Tch
 $I(AV)=f(\text{starting Tch}), \text{Non Repetitive}$

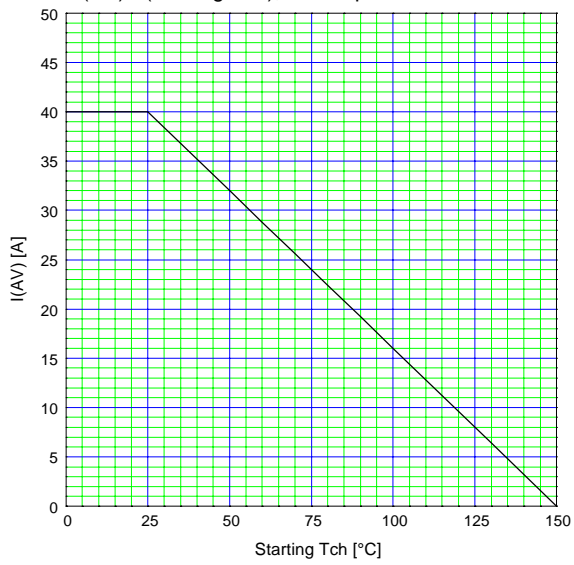

Transient Thermal Impedance
 $Z_{th}(ch-c)=f(t): D=t/T$

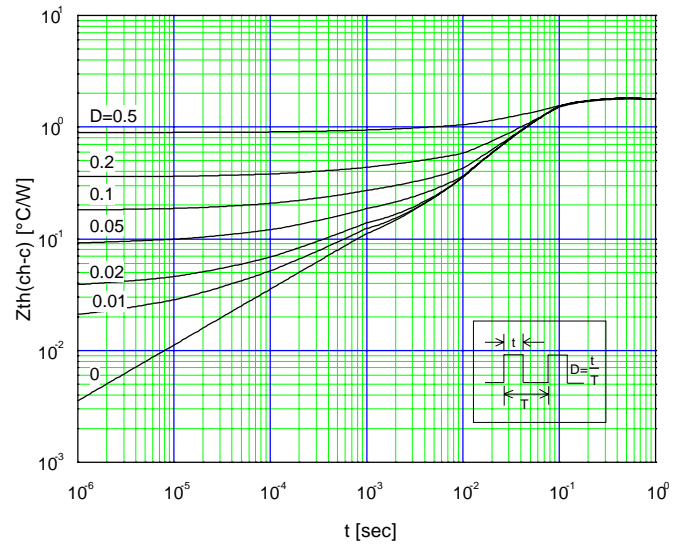

Maximum Avalanche energy vs. starting Tch
 $E_{as}=f(\text{starting Tch}): V_{cc}=24V, I_{AV} \le 40A, \text{Non-Repitative}$

