

# SPECIFICATION

DEVICE NAME : Power MOSFET

TYPE NAME : 2SK2918-01

SPEC. No. :

This material and the information herein is the property of Fuji Electric Co. Ltd. They shall be neither reproduced, copied, lent, or disclosed in any way whatsoever for the use of any third party nor used for the manufacturing purposes without the express written consent of Fuji Electric Co., Ltd.

Fuji Electric Co., Ltd.  
Matsumoto Factory

	DATE	NAME	APPROVED	Fuji Electric Co., Ltd.	
DRAWN				DWG. NO.	1/11
CHECKED					

H04-004-07

1. Scope  
This specifies Fuji power MOSFET 2SK2918-01
2. Construction N-channel enhancement mode power MOSFET
3. Application for switching
4. Outview T0-220 Outview See to 5/11 page
5. Absolute maximum ratings at  $T_c=25^\circ\text{C}$  (unless otherwise specified)

Description	Symbol	Characteristics	Unit	
Drain-source voltage	$V_{DS}$	200	V	
Drain-gate voltage	$V_{DGR}$	200	V	
Continuous Drain current	$I_D$	$\pm 20$	A	
Pulsed drain current	$I_{DPULSE}$	$\pm 80$	A	
Gate-source voltage	$V_{GS}$	$\pm 30$	V	
Maximum power dissipation	$P_D$	80	W	
Operating and storage temperature range	$T_{ch}$	150	$^\circ\text{C}$	
	$T_{sto}$	-55 ~ +150	$^\circ\text{C}$	

6. Electrical characteristics at  $T_c=25^\circ\text{C}$  (unless otherwise specified)
- Static ratings

Description	Symbol	Conditions	Characteristics			Unit	
			Min.	Typ.	Max.		
Drain-source breakdown voltage	$BV_{DSS}$	$I_D = 1\text{mA}$ $V_{GS} = 0\text{V}$	200			V	
Gate threshold voltage	$V_{GS(th)}$	$I_D = 1\text{mA}$ $V_{DS} = V_{GS}$	2.5	3.0	3.5	V	
Zero gate voltage drain current	$I_{DSS}$	$V_{DS} = 200\text{V}$ $V_{GS} = 0\text{V}$	$T_{ch} = 25^\circ\text{C}$		10	500	$\mu\text{A}$
	$I_{DSS}$		$T_{ch} = 125^\circ\text{C}$		0.2	1.0	mA
Gate-source leakage current	$I_{GSS}$	$V_{GS} = \pm 30\text{V}$ $V_{DS} = 0\text{V}$		10	100	nA	
Drain-source on-state resistance	$R_{DS(on)}$	$I_D = 10\text{A}$ $V_{GS} = 10\text{V}$		100	130	$\text{m}\Omega$	

This material and the information herein is the property of Fuji Electric Co. Ltd. They shall be neither reproduced, copied, lent, or disclosed in any way whatsoever for the use of any third party nor used for the manufacturing purposes without the express written consent of Fuji Electric Co., Ltd.

Dynamic ratings

Description	Symbol	Conditions	Characteristics			Unit
			Min.	Typ.	Max.	
Forward transconductance	$g_{fs}$	$I_D = 10A$ $V_{DS} = 25V$	7.0	15.0		S
Input capacitance	$C_{iss}$	$V_{DS} = 25V$ $V_{GS} = 0V$ $f = 1MHz$		1800	2700	pF
Output capacitance	$C_{oss}$			320	480	pF
Reverse transfer capacitance	$C_{rss}$			80	120	pF
Turn-on time	$t_{d(on)}$	$V_{CC} = 150V$ $V_{GS} = 10V$ $I_D = 20A$ $R_{GS} = 10\Omega$		15	25	ns
	$t_r$			60	90	ns
Turn-off time	$t_{d(off)}$			65	100	ns
	$t_f$			60	90	ns

Reverse diode

Description	Symbol	Conditions	Characteristics			Unit
			Min.	Typ.	Max.	
Avalanche capability	$I_{AV}$	$L = 100\mu H$ , $T_{ch} = 25^\circ C$ *See Fig.1 and 2	20.0			A
Diode forward on-voltage	$V_{SD}$	$I_F = 2 \times I_{DR}$ $V_{GS} = 0V$ , $T_{ch} = 25^\circ C$		1.06	1.59	V
Reverse recovery time	$t_{rr}$	$I_F = I_{DR}$ $V_{GS} = 0V$ $-di_F/dt = 100A/\mu s$ $T_{ch} = 25^\circ C$		145		ns
Reverse recovery charge	$Q_{rr}$				900	

7. Thermal resistance

Description	Symbol	Conditions	Characteristics			Unit
			Min.	Typ.	Max.	
Thermal resistance	$R_{th_{ch-c}}$				1.56	$^\circ C/W$
	$R_{th_{ch-a}}$				75.0	$^\circ C/W$

This material and the information herein is the property of Fuji Electric Co., Ltd. They shall be neither reproduced, copied, lent, or disclosed in any way whatsoever for the use of any third party nor used for the manufacturing purposes without the express written consent of Fuji Electric Co., Ltd.

Fig.1 Test circuit

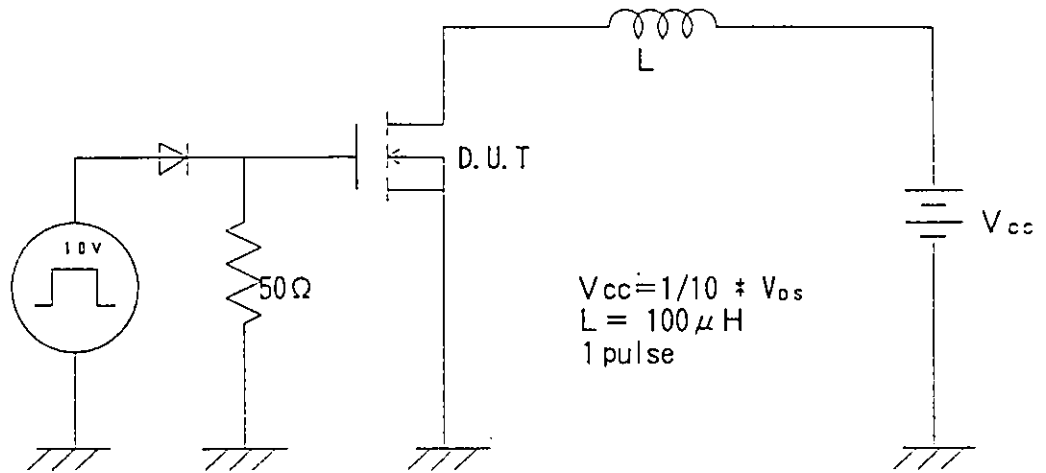
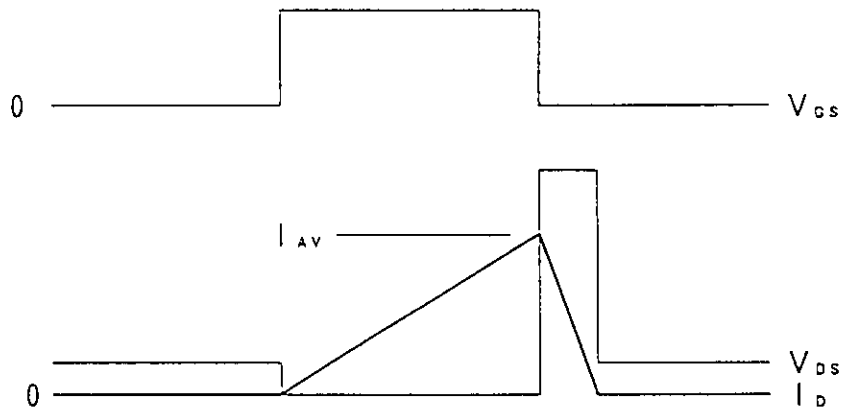
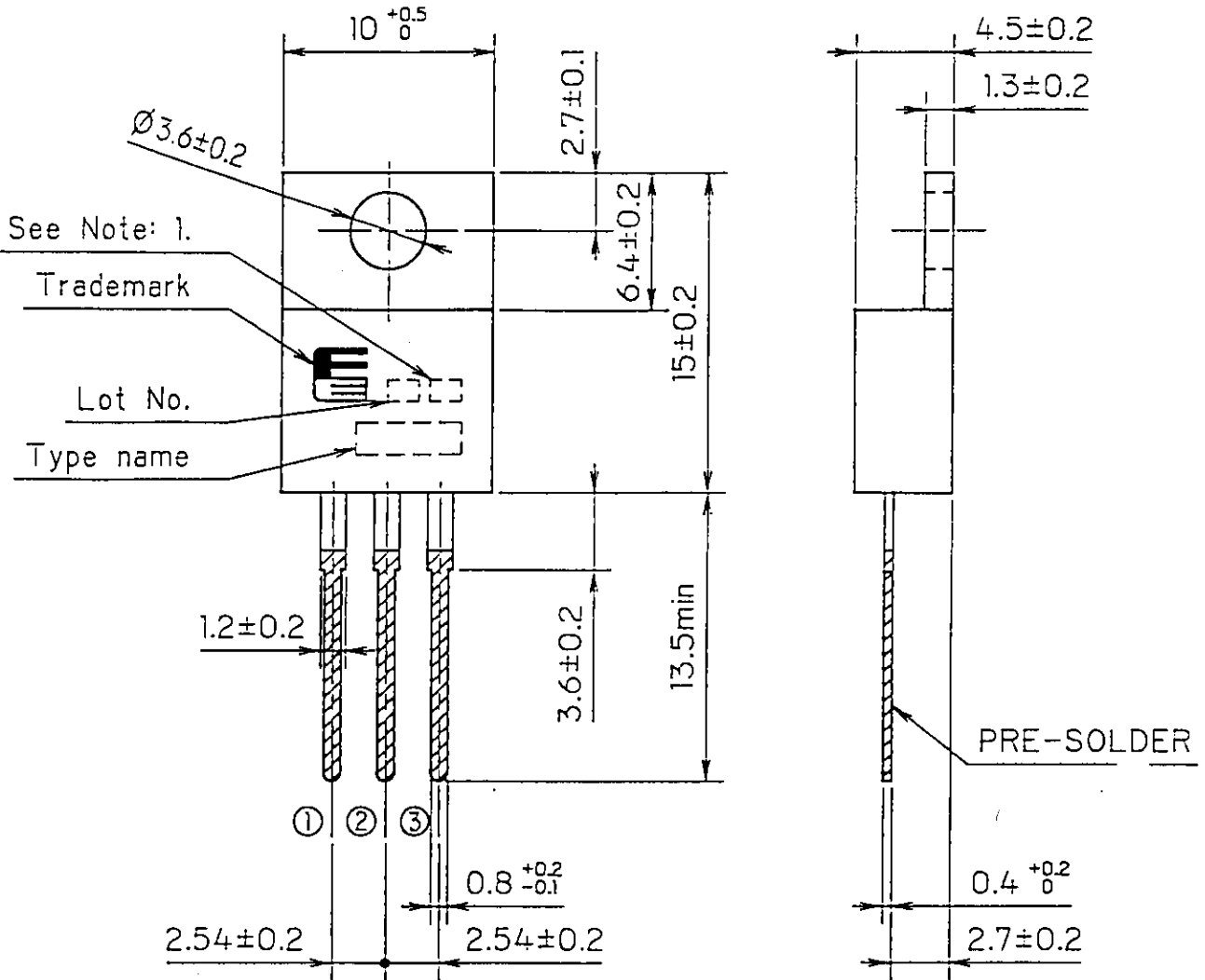

Fig.2 Operating waveforms



# FUJI POWER MOS FET

TYPE : 2SK2918-01



## CONNECTION

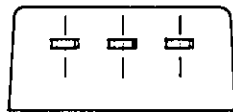

① ② ③

- ① GATE
- ② DRAIN
- ③ SOURCE

Note: 1.  $V_{GS(th)}$  selected code.

JEDEC : TO-220AB

Note: 1. Guaranteed mark of avalanche ruggedness.

DIMENSIONS ARE IN MILLIMETERS.

Fuji Electric Co., Ltd.

DWG. NO.

5/11

H04-004-03

This material and the information herein is the property of Fuji Electric Co., Ltd. They shall be neither reproduced, copied, lent, or disclosed in any way whatsoever for the use of any third party, nor used for the manufacturing purposes without the express written consent of Fuji Electric Co., Ltd.

This material and the information herein is the property of Fuji Electric Co., Ltd. They shall be neither reproduced, copied, lent, or disclosed in any way whatsoever for the use of any third party nor used for the manufacturing purposes without the express written consent of Fuji Electric Co., Ltd.

### Power Dissipation PD=f(Tc)

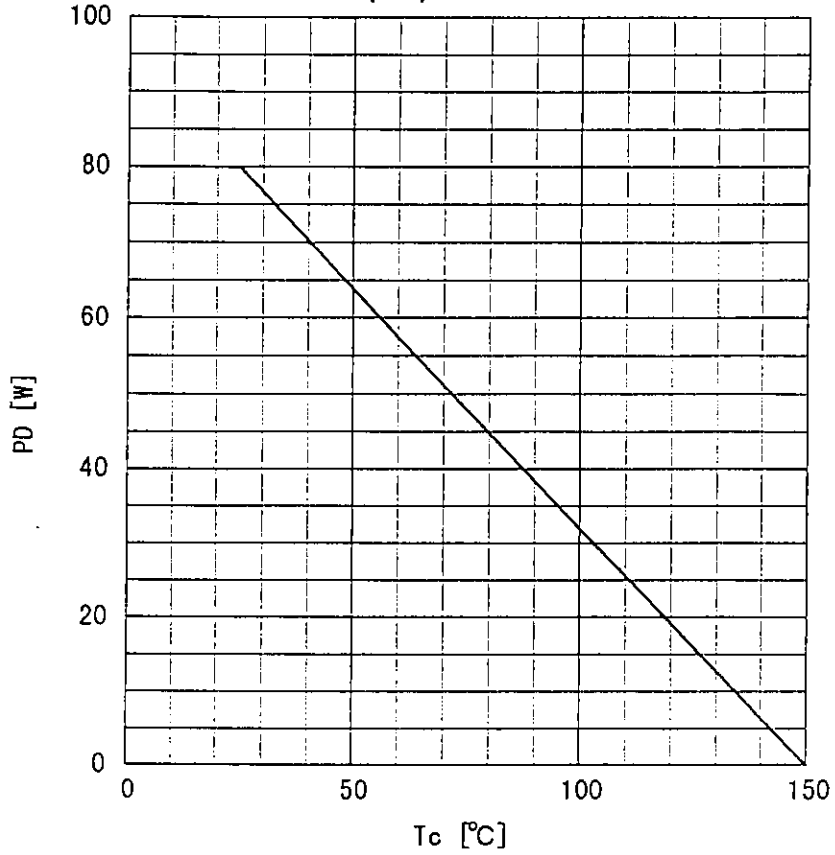

### Safe operating area ID=f(VDS) : D=0.01, Tc=25°C

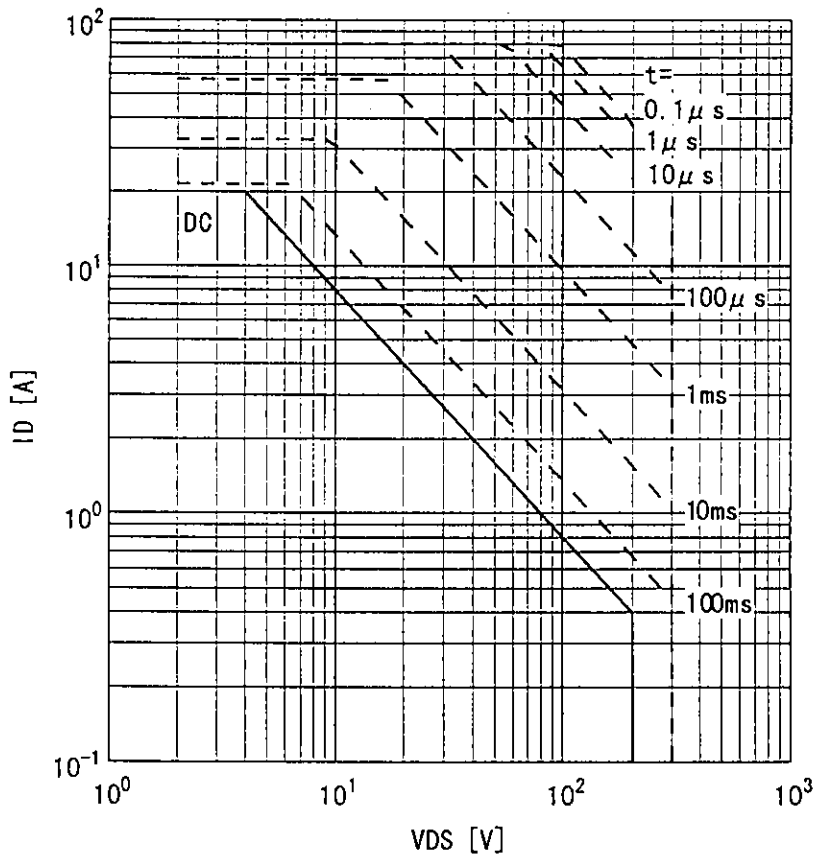

Typical output characteristics  
 $I_D = f(V_{DS})$ : 80  $\mu$ s pulse test,  $T_{ch} = 25^\circ\text{C}$

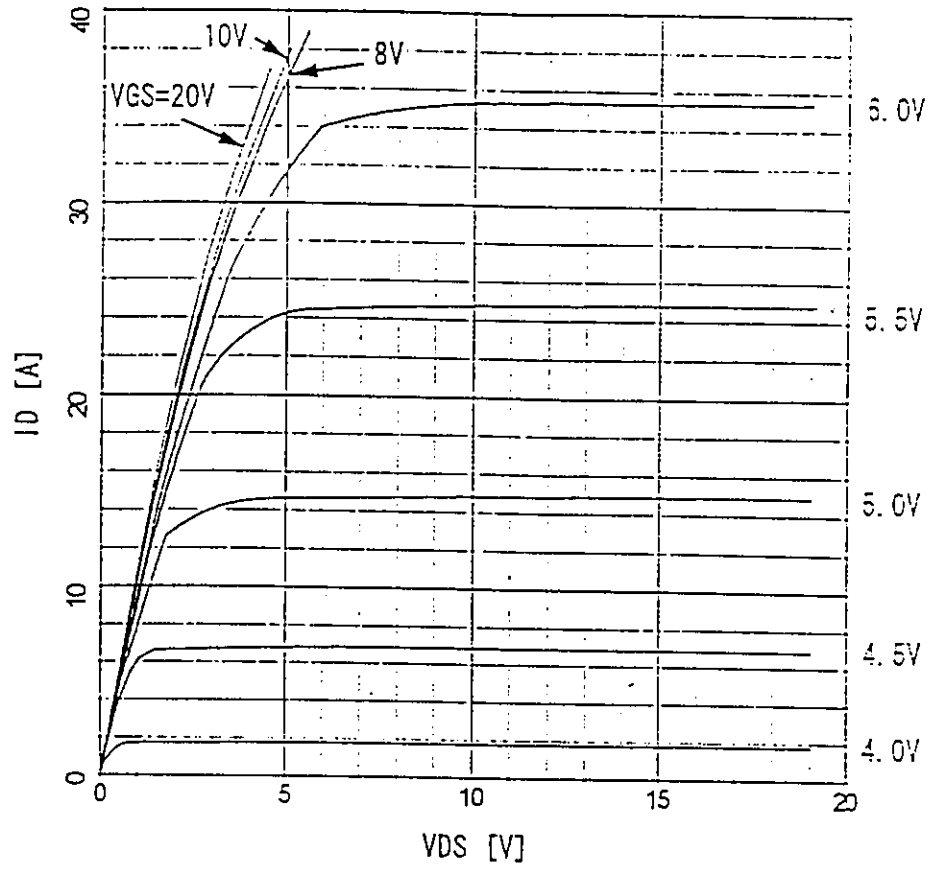

Typical transfer characteristic  
 $I_D = f(V_{GS})$ : 80  $\mu$ s pulse test,  $V_{DS} = 25V$ ,  $T_{ch} = 25^\circ\text{C}$

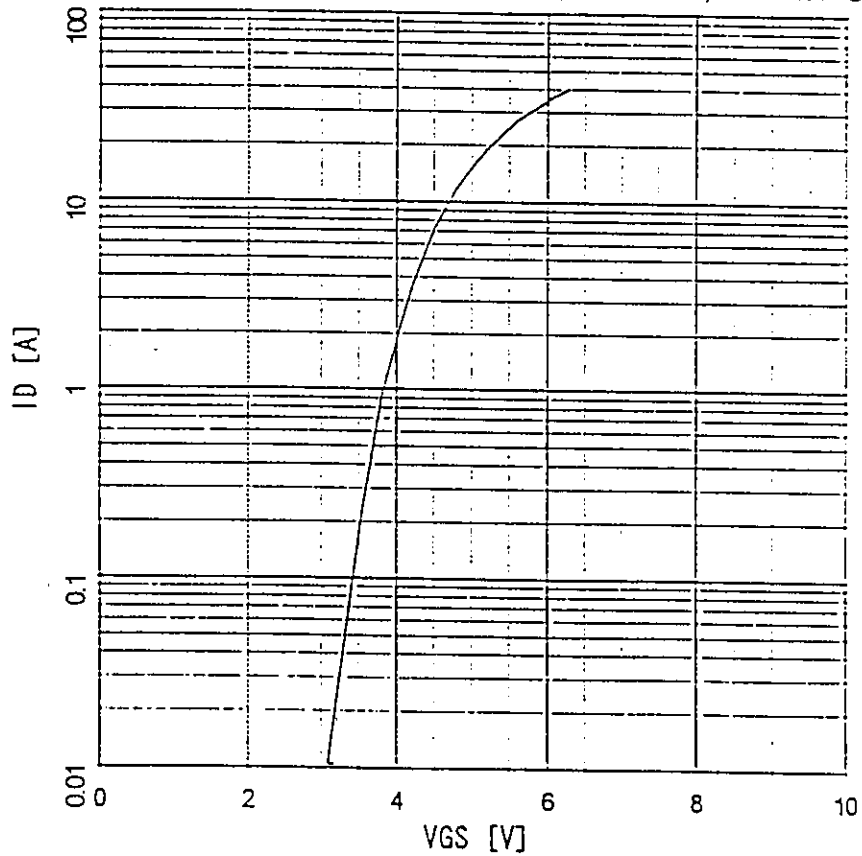

Typical transconductance  
 $g_{fs} = f(I_D)$ :  $80 \mu s$  pulse test,  $V_{DS} = 25V$ ,  $T_{ch} = 25^\circ C$

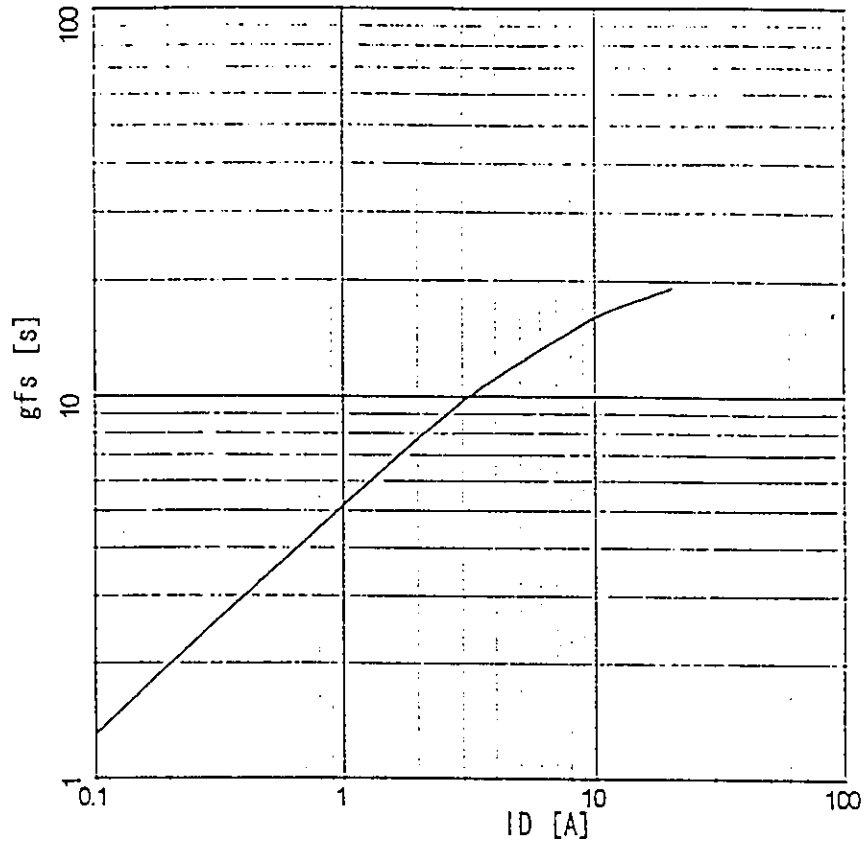

Typical drain-source on-state resistance  
 $R_{DS(on)} = f(I_D)$ :  $T_{ch} = 25^\circ C$

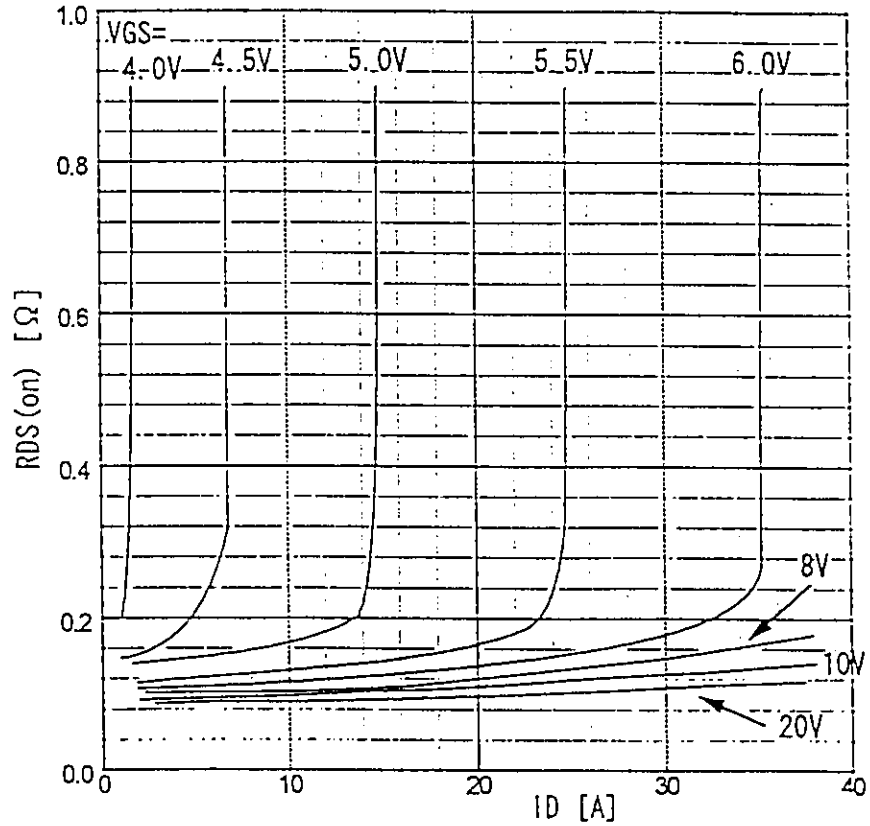



Drain-source on-state resistance  
 $R_{DS(on)} = f(T_{ch}) : I_D = 10A, V_{GS} = 10V$

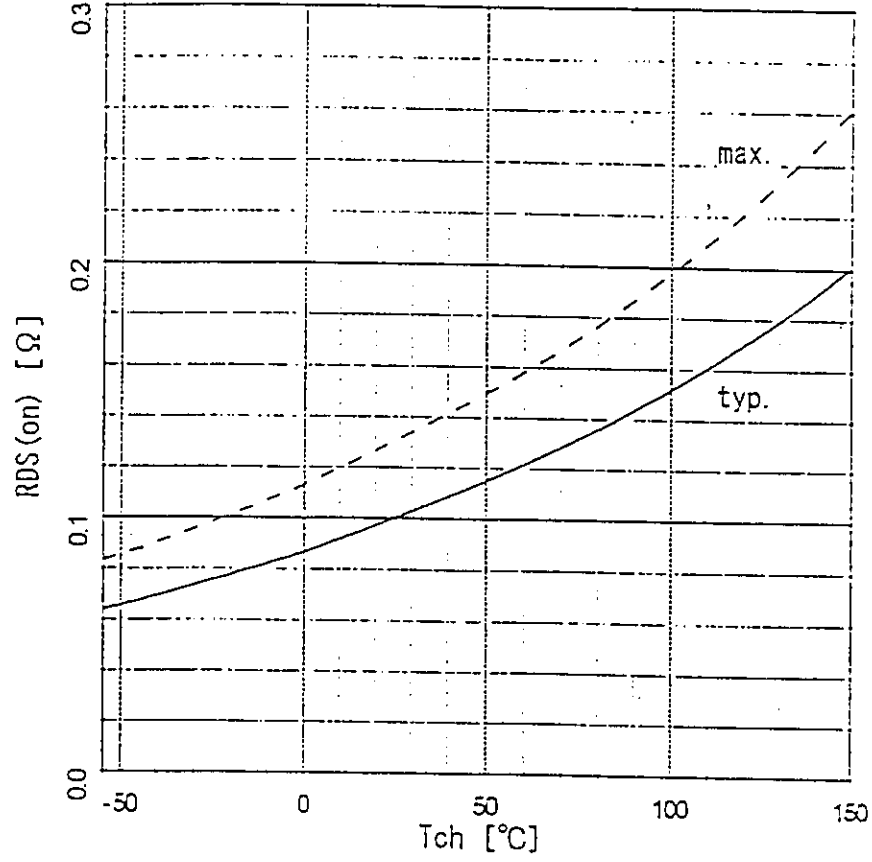

Gate threshold voltage  
 $V_{GS(th)} = f(T_{ch}) : I_D = 1mA, V_{DS} = V_{GS}$

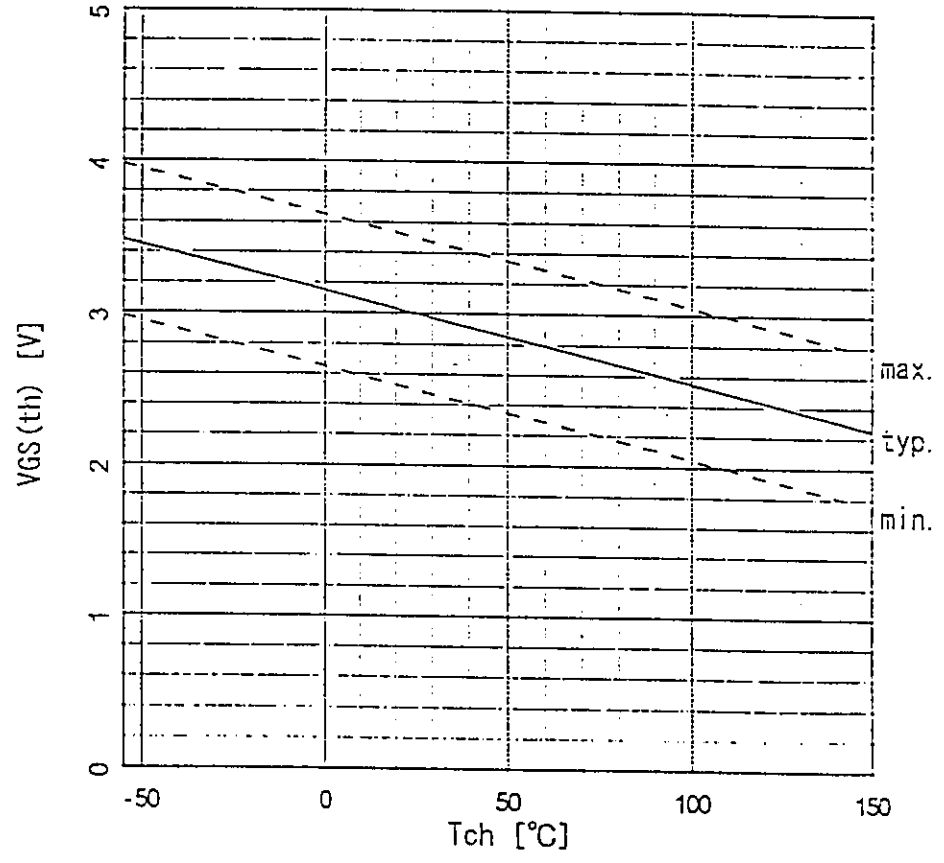

Typical capacitances  
 $C=f(V_{DS}) : V_{GS}=0V, f=1MHz$

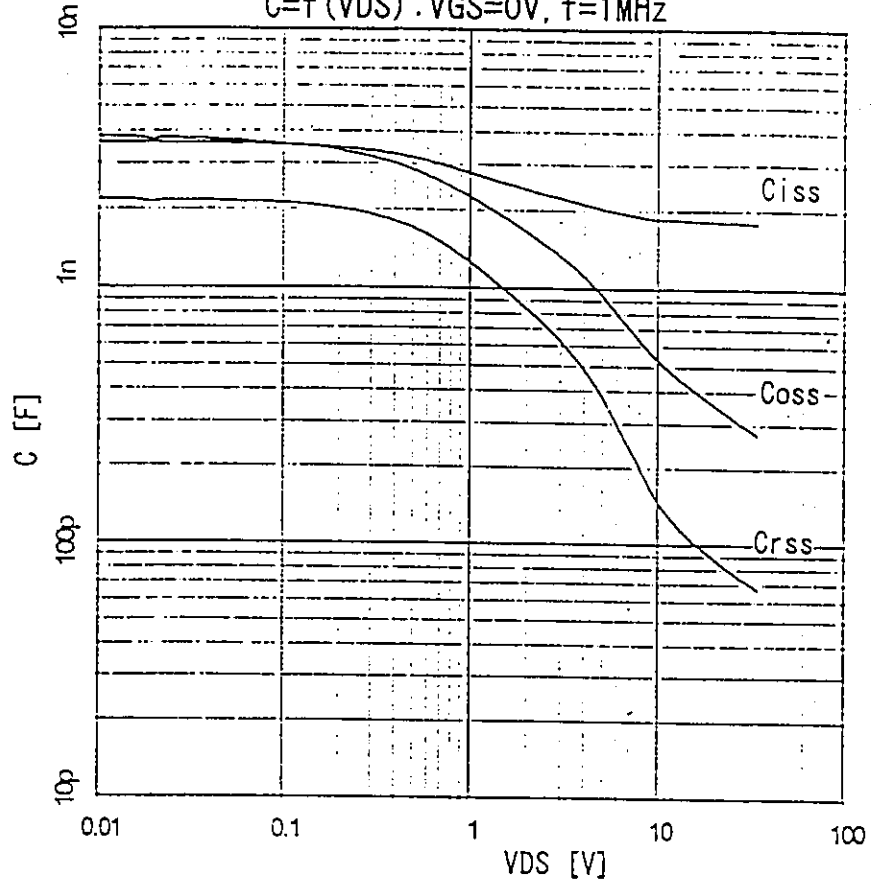

Typical gate charge characteristics  
 $V_{GS}=f(Q_g) : I_D=20A$

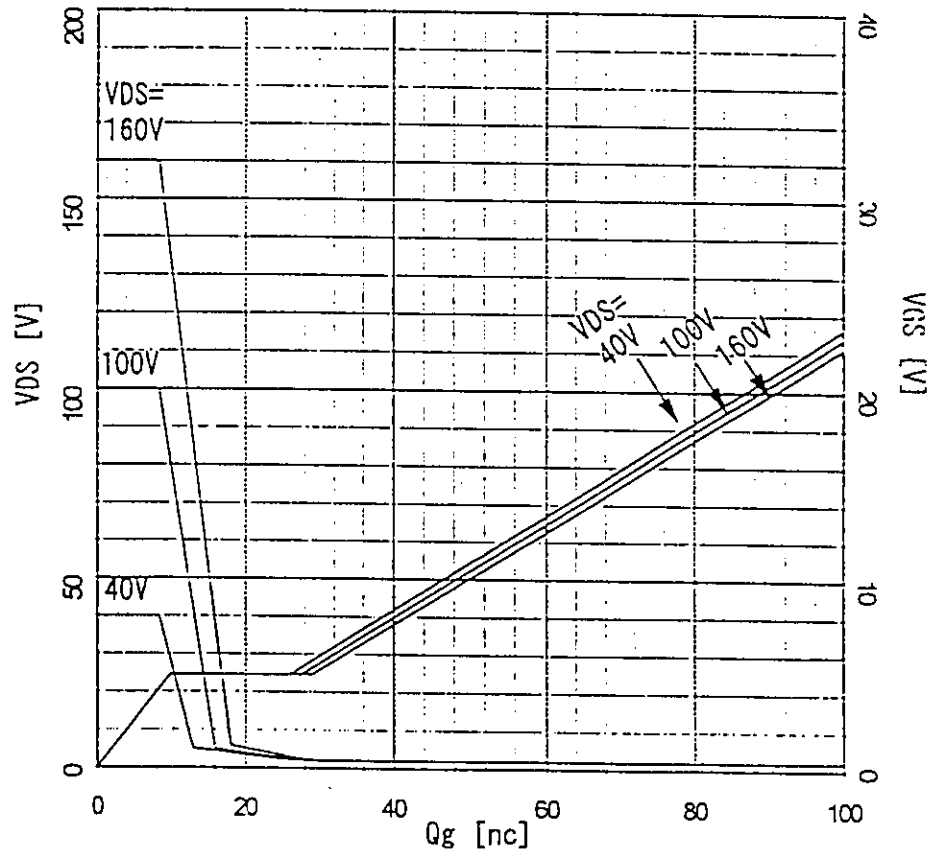

Forward characteristic of reverse diode  
 $I_F = f(V_{SD}) : 80 \mu s$  pulses test

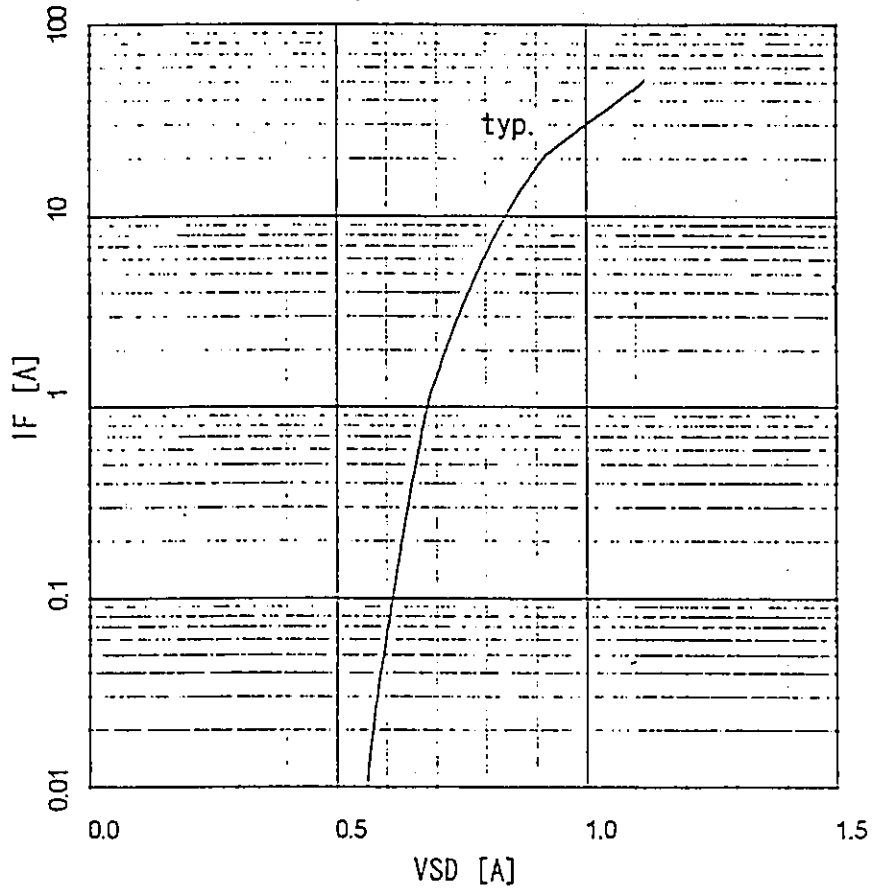

Transient thermal impedance  
 $Z_{thc} = f(t)$  parameter:  $D = t/T$

