

**> Features**

- High Speed Switching
- Low On-Resistance
- No Secondary Breakdown
- Low Driving Power
- High Voltage
- $V_{GS} = \pm 30V$  Guarantee
- Repetitive Avalanche Rated

**> Applications**

- Switching Regulators
- UPS
- DC-DC converters
- General Purpose Power Amplifier

**> Outline Drawing**

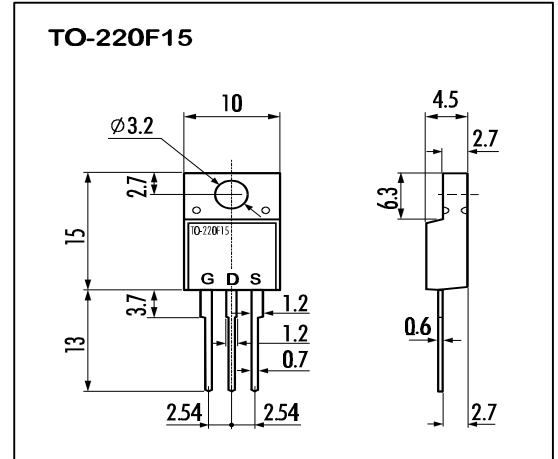

**> Maximum Ratings and Characteristics**

- Absolute Maximum Ratings ( $T_C=25^\circ C$ ), unless otherwise specified

Item	Symbol	Rating	Unit
Drain-Source-Voltage	$V_{DS}$	30	V
Continuous Drain Current	$I_D$	±35	A
Pulsed Drain Current	$I_{D(puls)}$	±140	A
Gate-Source-Voltage	$V_{GS}$	±16	V
Max. Avalanche Energy	$E_{AV}$	129.3	mJ
Max. Power Dissipation	$P_D$	20	W
Operating and Storage Temperature Range	$T_{ch}$	150	$^\circ C$
	$T_{stg}$	-55 ~ +150	$^\circ C$

$L=0.70mH, V_{CC}=12V$

**> Equivalent Circuit**

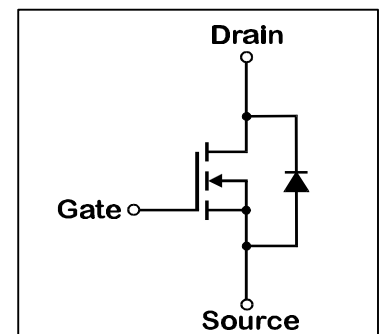

- Electrical Characteristics ( $T_C=25^\circ C$ ), unless otherwise specified

Item	Symbol	Test conditions	Min.	Typ.	Max.	Unit
Drain-Source Breakdown-Voltage	$BV_{DSS}$	$I_D=1mA, V_{GS}=0V$	30			V
Gate Threshold Voltage	$V_{GS(th)}$	$I_D=1mA, V_{DS}=V_{GS}$	1,0	1,5	2,0	V
Zero Gate Voltage Drain Current	$I_{DSS}$	$V_{DS}=30V, T_{ch}=25^\circ C, V_{GS}=0V$		10	500	$\mu A$
		$T_{ch}=125^\circ C$		0,2	1,0	mA
Gate Source Leakage Current	$I_{GSS}$	$V_{GS}=\pm 16V, V_{DS}=0V$		10	100	nA
Drain Source On-State Resistance	$R_{DS(on)}$	$I_D=17,5A, V_{GS}=4V$		22	30	$m\Omega$
		$V_{GS}=10V$		14	20	$m\Omega$
Forward Transconductance	$g_{fs}$	$I_D=17,5A, V_{DS}=25V$	16	33		S
Input Capacitance	$C_{iss}$	$V_{DS}=25V, V_{GS}=0V$		1100	1650	pF
Output Capacitance	$C_{oss}$	$f=1MHz$		550	830	pF
Reverse Transfer Capacitance	$C_{rss}$			240	360	pF
Turn-On-Time $t_{on} (t_{on}=t_{d(on)}+t_r)$	$t_{d(on)}$	$V_{CC}=15V, I_D=35A, V_{GS}=10V, R_{GS}=10\Omega$		9	15	ns
	$t_r$			75	115	ns
Turn-Off-Time $t_{off} (t_{off}=t_{d(off)}+t_f)$	$t_{d(off)}$			15	23	ns
	$t_f$			50	75	ns
Avalanche Capability	$I_{AV}$	$L = 100\mu H, T_{ch}=25^\circ C$	35			A
Diode Forward On-Voltage	$V_{SD}$	$I_F=2I_{DR}, V_{GS}=0V, T_{ch}=25^\circ C$		0,98	1,71	V
Reverse Recovery Time	$t_{rr}$	$I_F=2I_{DR}, V_{GS}=0V$		50		ns
Reverse Recovery Charge	$Q_{rr}$	$-di_F/dt=100A/\mu s, T_{ch}=25^\circ C$		0,08		$\mu C$

- Thermal Characteristics

Item	Symbol	Test conditions	Min.	Typ.	Max.	Unit
Thermal Resistance	$R_{th(ch-c)}$	channel to case			6,25	$^\circ C/W$
	$R_{th(ch-a)}$	channel to air			62,5	$^\circ C/W$

# N-channel MOS-FET

30V 20mΩ ±35A 20W

# 2SK2808-01MR

## FAP-IIS Series



### > Characteristics

Typical Output Characteristics

$I_D = f(V_{DS})$ ; 80μs pulse test;  $T_{ch} = 25^\circ\text{C}$

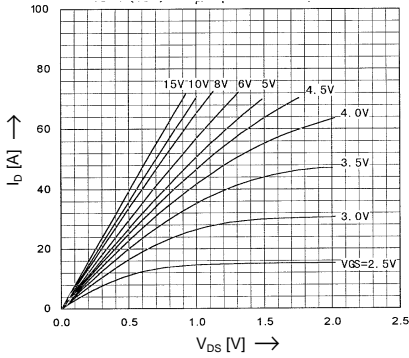

Drain-Source-On-State Resistance vs.  $T_{ch}$

$R_{DS(on)} = f(T_{ch})$ ;  $I_D = 17.5\text{A}$ ;  $V_{GS} = 10\text{V}$

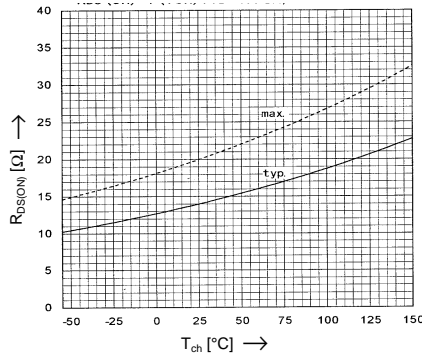

Typical Transfer Characteristics

$I_D = f(V_{GS})$ ; 80μs pulse test;  $V_{DS} = 25\text{V}$ ;  $T_{ch} = 25^\circ\text{C}$

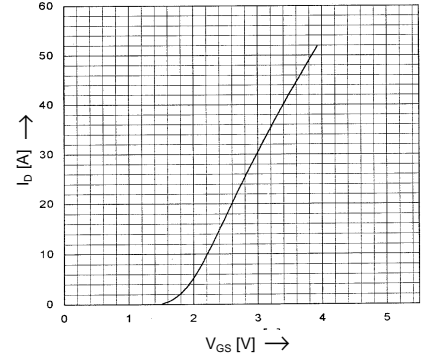

Typical Drain-Source-On-State-Resistance vs.  $I_D$

$R_{DS(on)} = f(I_D)$ ; 80μs pulse test;  $T_{ch} = 25^\circ\text{C}$

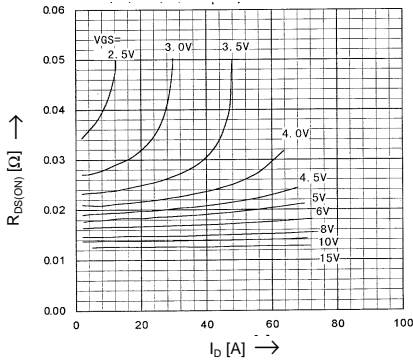

Typical Forward Transconductance vs.  $I_D$

$g_{fs} = f(I_D)$ ; 80μs pulse test;  $V_{DS} = 25\text{V}$ ;  $T_{ch} = 25^\circ\text{C}$

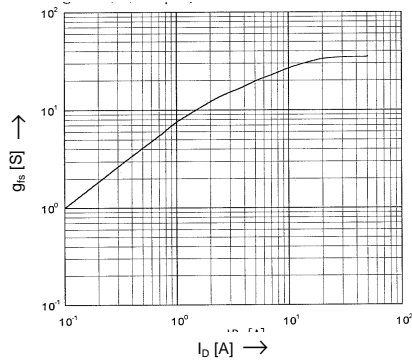

Gate Threshold Voltage vs.  $T_{ch}$

$V_{GS(th)} = f(T_{ch})$ ;  $I_D = 1\text{mA}$ ;  $V_{DS} = V_{GS}$

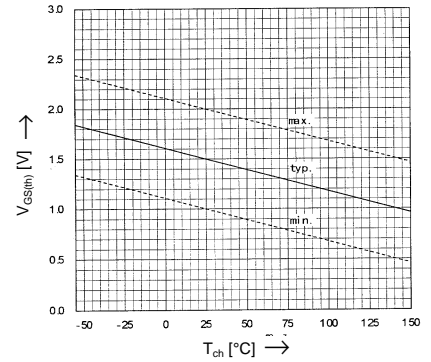

Typical Capacitances vs.  $V_{DS}$

$C = f(V_{DS})$ ;  $V_{GS} = 0\text{V}$ ;  $f = 1\text{MHz}$

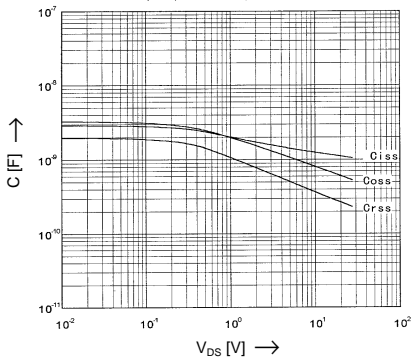

Typical Gate Charge Characteristic

$V_{GS} = f(Q_g)$ ;  $I_D = 35\text{A}$ ;  $T_{ch} = 25^\circ\text{C}$

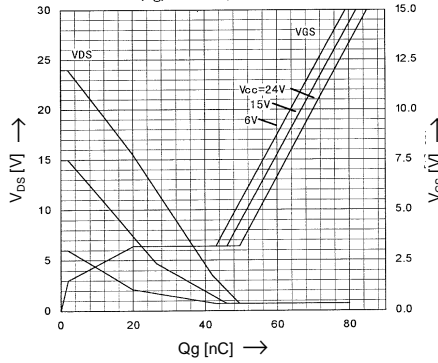

Forward Characteristics of Reverse Diode

$I_F = f(V_{SD})$ ; 80μs pulse test;  $V_{GS} = 0\text{V}$ ;  $T_{ch} = 25^\circ\text{C}$

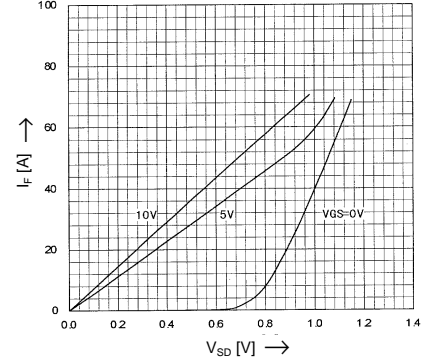

Avalanche Energy Derating

$E(AV) = f(\text{starting } T_{ch})$ ;  $V_{CC} = 12\text{V}$ ;  $I_{(AV)} = 35\text{A}$

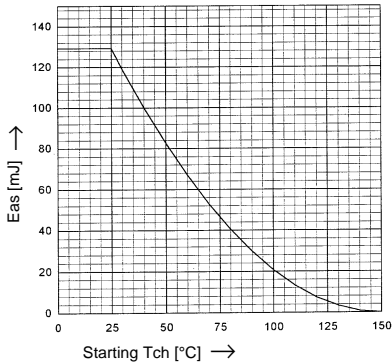

Safe operation area

$I_D = f(V_{DS})$ ;  $D = 0.01$ ;  $T_{ch} = 25^\circ\text{C}$

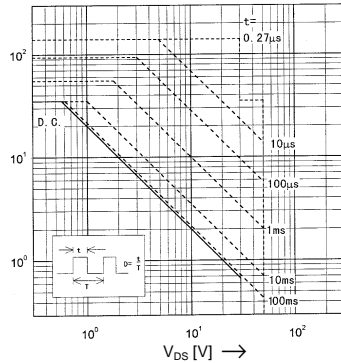

$Z_{th(ch-c)}$  [K/W]

Transient thermal impedance

$Z_{th(ch-c)} = f(t)$  parameter:  $D = t/T$

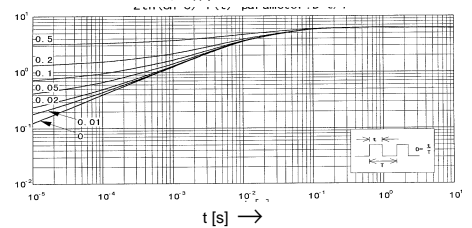

N-channel MOS-FET			
30V	20mΩ	±35A	20W

# 2SK2808-01MR

## FAP-IIS Series



### > Characteristics

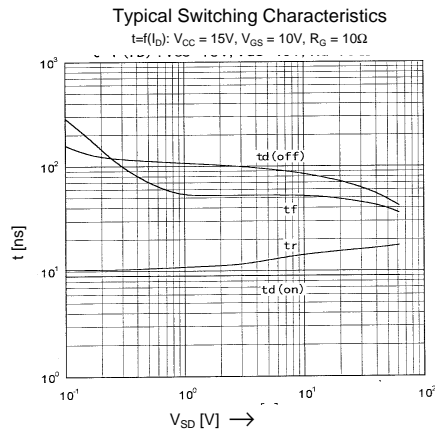

Power Dissipation  
 $P_D=f(T_C)$

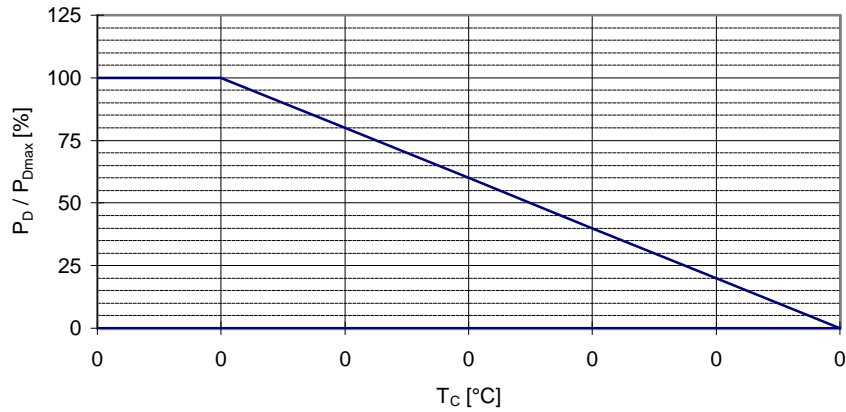

Maximum Avalanche Current vs. starting  $T_{ch}$   
 $I_{AV}=f(\text{starting } T_{ch})$

