

> **Features**

- High Speed Switching
- Low On-Resistance
- No Secondary Breakdown
- Low Driving Power
- High Voltage
- $V_{GS} = \pm 30V$  Guarantee
- Repetitive Avalanche Rated

> **Applications**

- Switching Regulators
- UPS
- DC-DC converters
- General Purpose Power Amplifier

> **Outline Drawing**

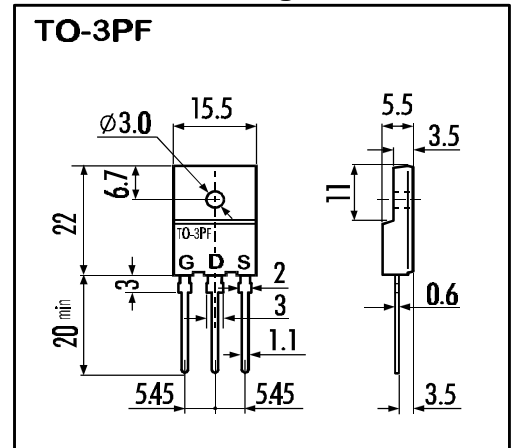

> **Maximum Ratings and Characteristics**

- Absolute Maximum Ratings ( $T_C=25^\circ C$ ), unless otherwise specified

Item	Symbol	Rating	Unit
Drain-Source-Voltage	$V_{DS}$	600	V
Continous Drain Current	$I_D$	9	A
Pulsed Drain Current	$I_{D(puls)}$	32	A
Gate-Source-Voltage	$V_{GS}$	$\pm 30$	V
Repetitive or Non-Repetitive ( $T_{ch} \leq 150^\circ C$ )	$I_{AR}$	9	A
Avalanche Energy	$E_{AS}$	117,6	mJ
Max. Power Dissipation	$P_D$	60	W
Operating and Storage Temperature Range	$T_{ch}$	150	$^\circ C$
	$T_{stg}$	-55 ~ +150	$^\circ C$

> **Equivalent Circuit**



- Electrical Characteristics ( $T_C=25^\circ C$ ), unless otherwise specified

Item	Symbol	Test conditions	Min.	Typ.	Max.	Unit
Drain-Source Breakdown-Voltage	$V_{(BR)DSS}$	$I_D=1mA$ $V_{GS}=0V$	600			V
Gate Threshold Voltage	$V_{GS(th)}$	$I_D=1mA$ $V_{DS}=V_{GS}$	3,5	4,0	4,5	V
Zero Gate Voltage Drain Current	$I_{DSS}$	$V_{DS}=600V$ $T_{ch}=25^\circ C$		10	500	$\mu A$
		$V_{GS}=0V$ $T_{ch}=125^\circ C$		0,2	1,0	mA
Gate Source Leakage Current	$I_{GSS}$	$V_{GS}=\pm 30V$ $V_{DS}=0V$		10	100	nA
Drain Source On-State Resistance	$R_{DS(on)}$	$I_D=4A$ $V_{GS}=10V$		1,0	1,2	$\Omega$
Forward Transconductance	$g_{fs}$	$I_D=4A$ $V_{DS}=25V$	2,5	5		S
Input Capacitance	$C_{iss}$	$V_{DS}=25V$		900	1400	pF
Output Capacitance	$C_{oss}$	$V_{GS}=0V$		150	230	pF
Reverse Transfer Capacitance	$C_{rss}$	$f=1MHz$		70	110	pF
Turn-On-Time $t_{on}$ ( $t_{on}=t_{d(on)}+t_r$ )	$t_{d(on)}$	$V_{CC}=300V$		25	40	ns
	$t_r$	$I_D=9A$		70	110	ns
Turn-Off-Time $t_{off}$ ( $t_{off}=t_{d(off)}+t_f$ )	$t_{d(off)}$	$V_{GS}=10V$		60	90	ns
	$t_f$	$R_{GS}=10\Omega$		35	60	ns
Avalanche Capability	$I_{AV}$	$L=100\mu H$ $T_{ch}=25^\circ C$	9			A
Diode Forward On-Voltage	$V_{SD}$	$I_F=2I_{DR}$ $V_{GS}=0V$ $T_{ch}=25^\circ C$		1,0	1,50	V
Reverse Recovery Time	$t_{rr}$	$I_F=I_{DR}$ $V_{GS}=0V$		550		ns
Reverse Recovery Charge	$Q_{rr}$	$-dI_F/dt=100A/\mu s$ $T_{ch}=25^\circ C$		7,0		$\mu C$

- Thermal Characteristics

Item	Symbol	Test conditions	Min.	Typ.	Max.	Unit
Thermal Resistance	$R_{th(ch-a)}$	channel to air			30	$^\circ C/W$
	$R_{th(ch-c)}$	channel to case			2,08	$^\circ C/W$

N-channel MOS-FET			
600V	1,2Ω	9A	60W

# 2SK2760-01

## FAP-IIS Series



### > Characteristics

Typical Output Characteristics

$I_D=f(V_{DS})$ ; 80μs pulse test;  $T_C=25^\circ\text{C}$

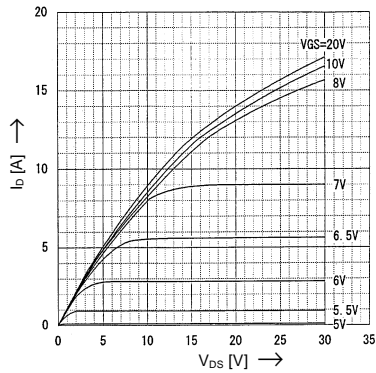

Drain-Source On-State Resistance vs.  $T_{ch}$

$R_{DS(on)}=f(T_{ch})$ ;  $I_D=4\text{A}$ ;  $V_{GS}=10\text{V}$

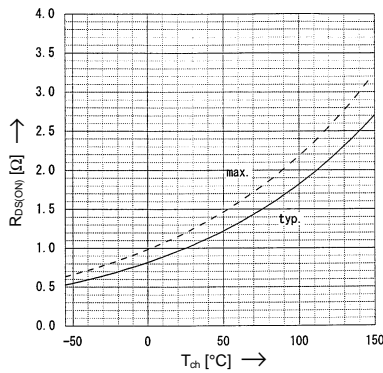

Typical Transfer Characteristics

$I_D=f(V_{GS})$ ; 80μs pulse test;  $V_{DS}=25\text{V}$ ;  $T_{ch}=25^\circ\text{C}$

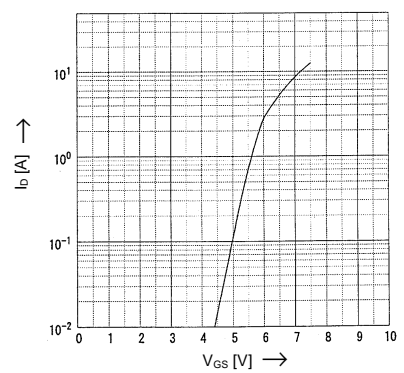

Typical Drain-Source On-State-Resistance vs.  $I_D$

$R_{DS(on)}=f(I_D)$ ; 80μs pulse test;  $T_C=25^\circ\text{C}$

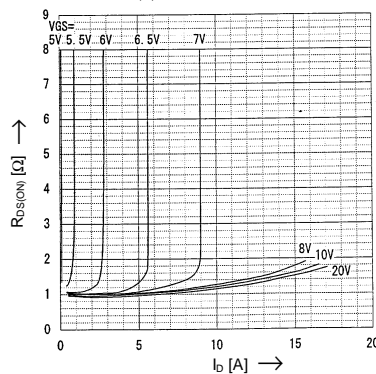

Typical Forward Transconductance vs.  $I_D$

$g_{fs}=f(I_D)$ ; 80μs pulse test;  $V_{DS}=25\text{V}$ ;  $T_{ch}=25^\circ\text{C}$

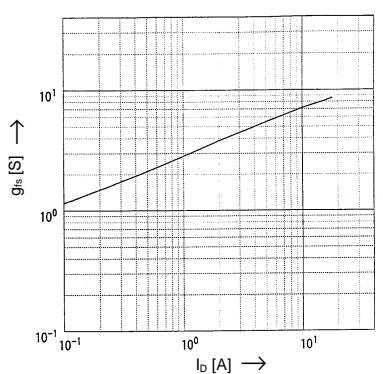

Gate Threshold Voltage vs.  $T_{ch}$

$V_{GS(th)}=f(T_{ch})$ ;  $I_D=1\text{mA}$ ;  $V_{DS}=V_{GS}$

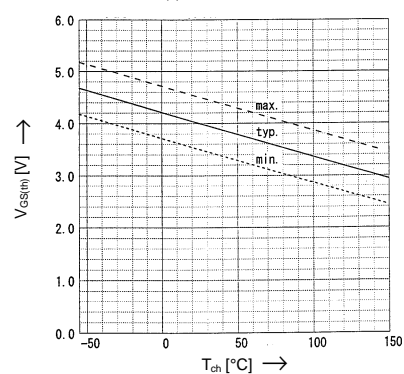

Typical Capacitances vs.  $V_{DS}$

$C=f(V_{DS})$ ;  $V_{GS}=0\text{V}$ ;  $f=1\text{MHz}$

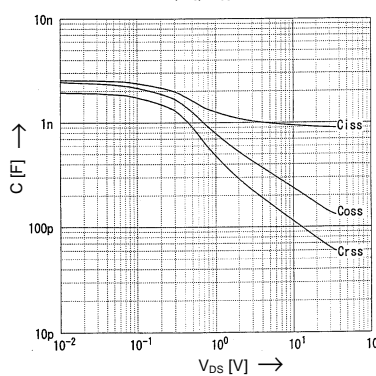

Typical Gate Charge Characteristic

$V_{GS}=f(Q_g)$ ;  $I_D=9\text{A}$ ;  $T_C=25^\circ\text{C}$

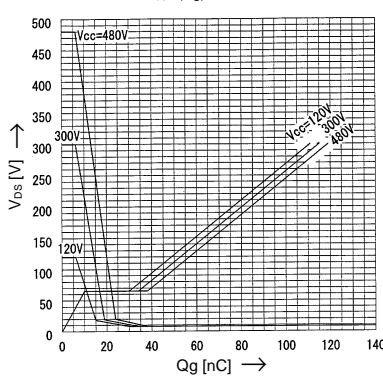

Forward Characteristics of Reverse Diode

$I_F=f(V_{SD})$ ; 80μs pulse test;  $V_{GS}=0\text{V}$

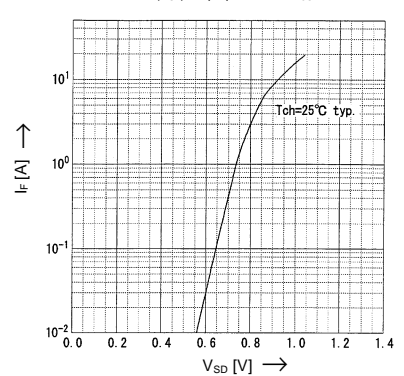

Avalanche Energy Derating

$E_{as}=f(\text{starting } T_{ch})$ ;  $V_{CC}=60\text{V}$ ;  $I_A=9\text{A}$

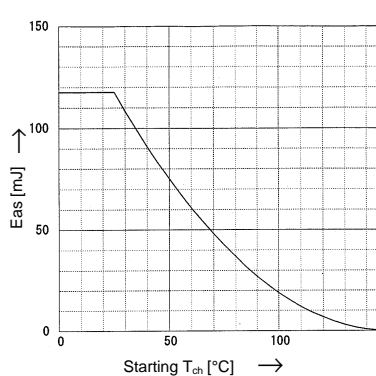

Safe Operation Area

$I_D=f(V_{DS})$ ;  $D=0.01$ ;  $T_C=25^\circ\text{C}$

