

> Features

- High Speed Switching
- Low On-Resistance
- No Secondary Breakdown
- Low Driving Power
- High Voltage
- $V_{GS} = \pm 30V$ Guarantee
- Repetitive Avalanche Rated

> Applications

- Switching Regulators
- UPS
- DC-DC converters
- General Purpose Power Amplifier

> Outline Drawing

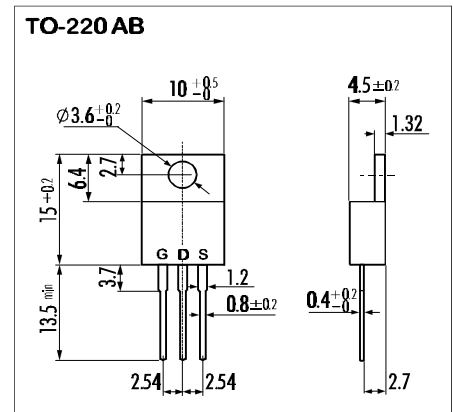

> Maximum Ratings and Characteristics

- Absolute Maximum Ratings($T_C=25^\circ C$), unless otherwise specified

Item	Symbol	Rating	Unit
Drain-Source-Voltage	V_{DS}	800	V
Continous Drain Current	I_D	4	A
Pulsed Drain Current	$I_{D(puls)}$	16	A
Gate-Source-Voltage	V_{GS}	± 30	V
Repetitive or Non-Repetitive ($T_{ch} \leq 150^\circ C$)	I_{AR}	4	A
Avalanche Energy	E_{AS}	254	mJ
Max. Power Dissipation	P_D	80	W
Operating and Storage Temperature Range	T_{ch}	150	$^\circ C$
	T_{stg}	-55 ~ +150	$^\circ C$

> Equivalent Circuit



- Electrical Characteristics ($T_C=25^\circ C$), unless otherwise specified

Item	Symbol	Test conditions	Min.	Typ.	Max.	Unit
Drain-Source Breakdown-Voltage	$V_{(BR)DSS}$	$I_D=1mA$ $V_{GS}=0V$	800			V
Gate Threshold Voltage	$V_{GS(th)}$	$I_D=1mA$ $V_{DS}=V_{GS}$	3,5	4,0	4,5	V
Zero Gate Voltage Drain Current	I_{DSS}	$V_{DS}=800V$ $T_{ch}=25^\circ C$		10	500	μA
		$V_{GS}=0V$ $T_{ch}=125^\circ C$		0,2	1,0	mA
Gate Source Leakage Current	I_{GSS}	$V_{GS}=\pm 30V$ $V_{DS}=0V$		10	100	nA
Drain Source On-State Resistance	$R_{DS(on)}$	$I_D=2A$ $V_{GS}=10V$		3,19	4,0	Ω
Forward Transconductance	g_{fs}	$I_D=2A$ $V_{DS}=25V$		2		S
Input Capacitance	C_{iss}	$V_{DS}=25V$		450		pF
Output Capacitance	C_{oss}	$V_{GS}=0V$		75		pF
Reverse Transfer Capacitance	C_{rss}	$f=1MHz$		40		pF
Turn-On-Time t_{on} ($t_{on}=t_{d(on)}+t_r$)	$t_{d(on)}$	$V_{CC}=600V$		20		ns
	t_r	$I_D=2A$		40		ns
Turn-Off-Time t_{off} ($t_{off}=t_{d(off)}+t_f$)	$t_{d(off)}$	$V_{GS}=10V$		50		ns
	t_f	$R_{GS}=10 \Omega$		25		ns
Avalanche Capability	I_{AV}	$L = 100\mu H$ $T_{ch}=25^\circ C$	4			A
Diode Forward On-Voltage	V_{SD}	$I_F=2I_{DR}$ $V_{GS}=0V$ $T_{ch}=25^\circ C$		1,0		V
Reverse Recovery Time	t_{rr}	$I_F=I_{DR}$ $V_{GS}=0V$		450		ns
Reverse Recovery Charge	Q_{rr}	$-dI_F/dt=100A/\mu s$ $T_{ch}=25^\circ C$		3,0		μC

- Thermal Characteristics

Item	Symbol	Test conditions	Min.	Typ.	Max.	Unit
Thermal Resistance	$R_{th(ch-a)}$	channel to air			75	$^\circ C/W$
	$R_{th(ch-c)}$	channel to case			1,56	$^\circ C/W$

N-channel MOS-FET			
800V	4Ω	4A	80W

2SK2646-01

FAP-IIS Series



> Characteristics

Typical Output Characteristics

$I_D=f(V_{DS})$; 80μs pulse test; $T_C=25^\circ\text{C}$

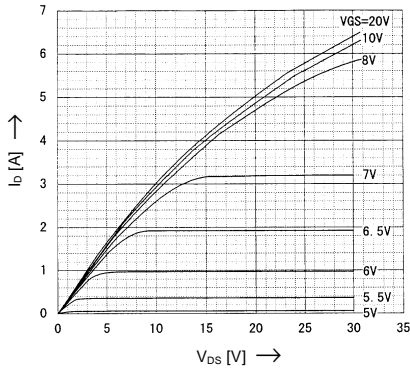

Drain-Source-On-State Resistance vs. T_{ch}

$R_{DS(on)}=f(T_{ch})$; $I_D=2\text{A}$; $V_{GS}=10\text{V}$

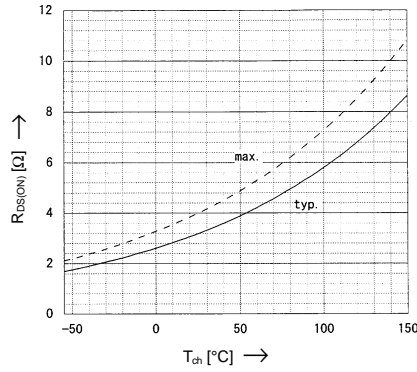

Typical Transfer Characteristics

$I_D=f(V_{GS})$; 80μs pulse test; $V_{DS}=25\text{V}$; $T_{ch}=25^\circ\text{C}$

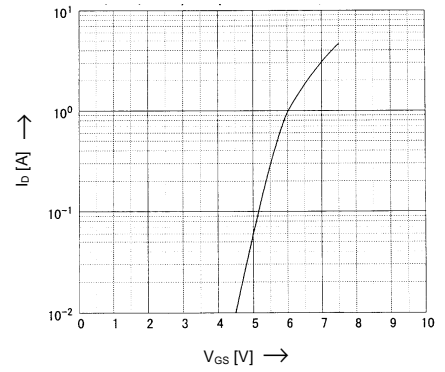

Typical Drain-Source-On-State-Resistance vs. I_D

$R_{DS(on)}=f(I_D)$; 80μs pulse test; $T_C=25^\circ\text{C}$

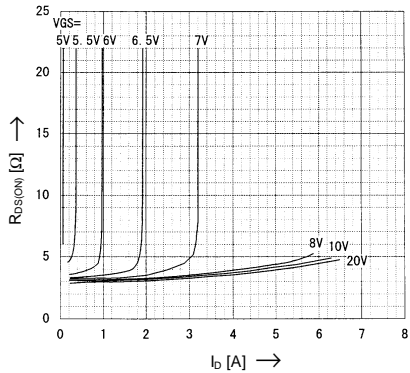

Typical Forward Transconductance vs. I_D

$g_{fs}=f(I_D)$; 80μs pulse test; $V_{DS}=25\text{V}$; $T_C=25^\circ\text{C}$

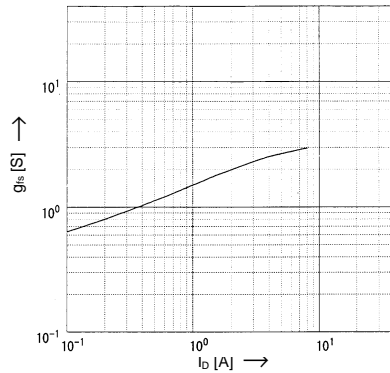

Gate Threshold Voltage vs. T_{ch}

$V_{GS(th)}=f(T_{ch})$; $I_D=1\text{mA}$; $V_{DS}=V_{GS}$

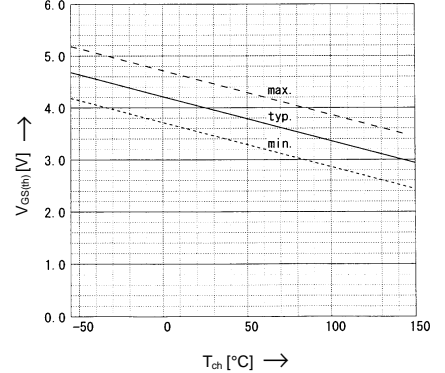

Typical Capacitances vs. V_{DS}

$C=f(V_{DS})$; $V_{GS}=0\text{V}$; $f=1\text{MHz}$

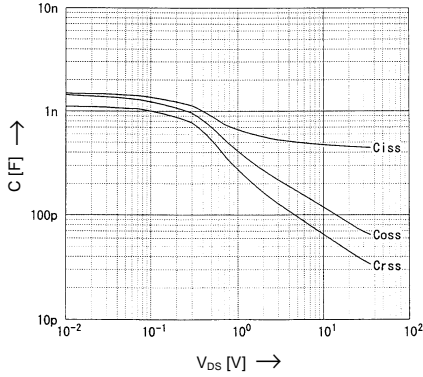

Avalanche Energy Derating

$E_{AS}=f(\text{starting } T_{ch})$; $V_{CC}=80\text{V}$; $I_{AV}=4\text{A}$

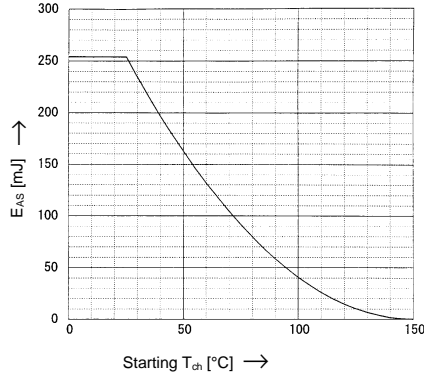

Forward Characteristics of Reverse Diode

$I_F=f(V_{SD})$; 80μs pulse test; $V_{GS}=0\text{V}$

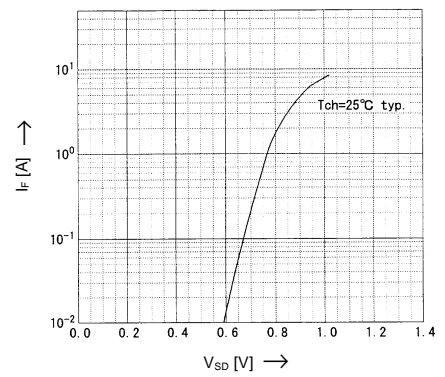

Power Dissipation

$P_D=f(T_C)$

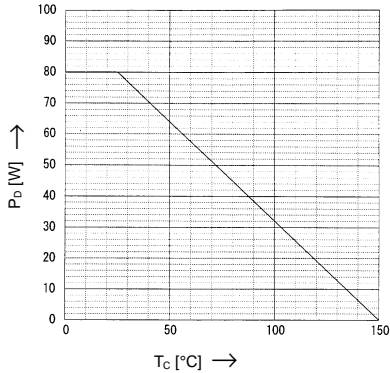

Safe operation area

$I_D=f(V_{DS})$; $D=0.01$; $T_C=25^\circ\text{C}$

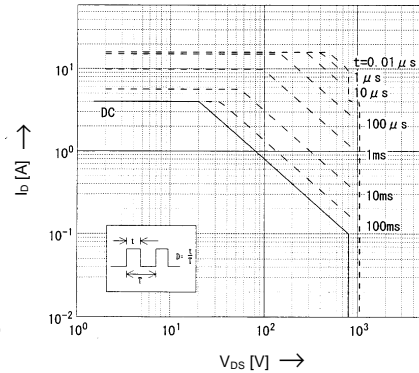

Transient Thermal impedance

Transient Thermal impedance

$Z_{th(ch-e)}=f(t)$ parameter: $D=l/T$

