

Features

- High speed switching
- Low on-resistance
- No secondary breakdown
- Low driving power
- High voltage
- $V_{GSS} = \pm 30V$ Guarantee
- Avalanche-proof

Applications

- Switching regulators
- UPS
- DC-DC converters
- General purpose power amplifier

Max. Ratings and Characteristics

Absolute Maximum Ratings($T_c = 25^\circ C$)

Items	Symbols	Ratings	Units
Drain-source voltage	V_{DSS}	900	V
Continuous drain current	I_D	3.5	A
Pulsed drain current	$I_{D(pulse)}$	9.0	A
Continuous reverse drain current	I_{DR}	3.5	A
Gate-source peak voltage	V_{GSS}	± 30	V
Max. power dissipation	P_D	40	W
Operating and storage temperature range	T_{ch} T_{stg}	150 -55 ~ +150	$^\circ C$

Electrical Characteristics($T_c = 25^\circ C$)

Items	Symbols	Test Conditions	Min.	Typ.	Max.	Units
Drain-source breakdown voltage	$V_{(BR)DSS}$	$I_D = 1mA$ $V_{GS} = 0V$	900			V
Gate threshold voltage	$V_{GS(th)}$	$I_D = 1mA$ $V_{DS} = V_{GS}$	2.5	3.5	5.0	V
Zero gate voltage drain current	I_{DSS}	$V_{DS} = 900V$ $V_{GS} = 0V$	$T_{ch} = 25^\circ C$	10	500	μA
			$T_{ch} = 125^\circ C$	0.2	1.0	mA
Gate-source leakage current	I_{GSS}	$V_{GS} = \pm 30V$ $V_{DS} = 0V$		10	100	nA
Drain-source on-state resistance	$R_{DS(on)}$	$I_D = 2A$ $V_{GS} = 10V$		4.0	5.5	Ω
Forward transconductance	g_{fs}	$I_D = 2A$ $V_{DS} = 25V$	2	4		S
Input capacitance	C_{iss}	$V_{DS} = 25V$		800	1200	pF
Output capacitance	C_{oss}	$V_{GS} = 0V$		80	120	
Reverse transfer capacitance	C_{rss}	$f = 1MHz$		30	45	
Turn-on time t_{on} ($t_{on} = t_{d(on)} + t_r$)	$t_{d(on)}$	$V_{CC} = 600V$ $I_D = 3.5A$ $V_{GS} = 10V$ $R_G = 25\Omega$		30	45	ns
	t_r			65	100	
Turn-off time t_{off} ($t_{off} = t_{d(off)} + t_r$)	$t_{d(off)}$			110	165	
	t_r			60	90	
Diode forward on-voltage	V_{SD}	$I_F = 2 \times I_{DR}$ $V_{GS} = 0V$ $T_{ch} = 25^\circ C$		0.90	1.35	V
Reverse recovery time	t_{rr}	$I_F = I_{DR}$ $d_i/d_t = 100A/\mu S$ $T_{ch} = 25^\circ C$		700		ns

Thermal Characteristics

Items	Symbols	Test Conditions	Min.	Typ.	Max.	Units
Thermal resistance	$R_{th(ch-a)}$	channel to air			62.5	$^\circ C/W$
	$R_{th(ch-c)}$	channel to case			3.125	$^\circ C/W$

Outline Drawings

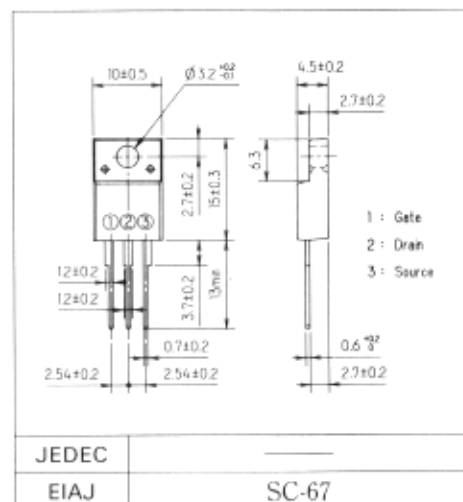

Equivalent Circuit Schematic

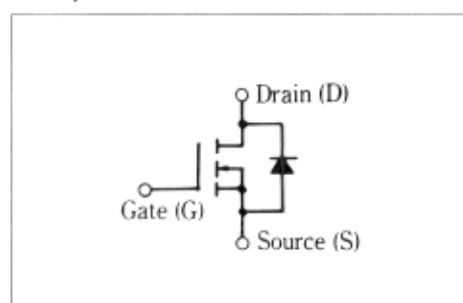

■ Characteristics

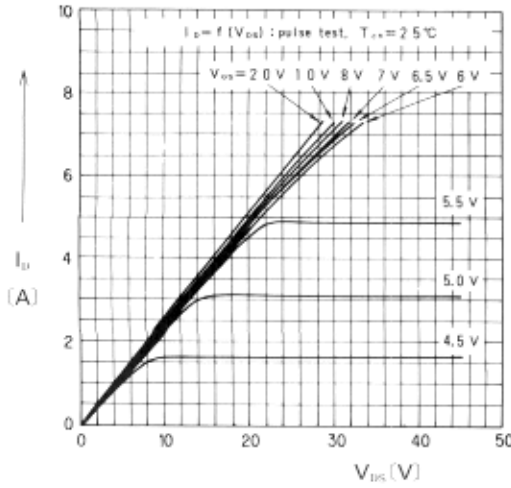

Typical Output Characteristics

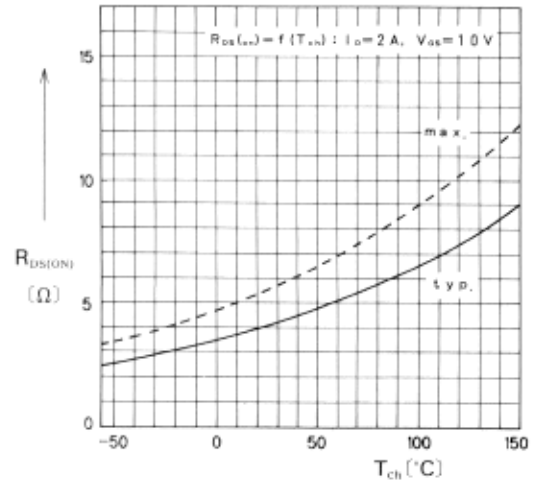

On State Resistance vs. T_{ch}

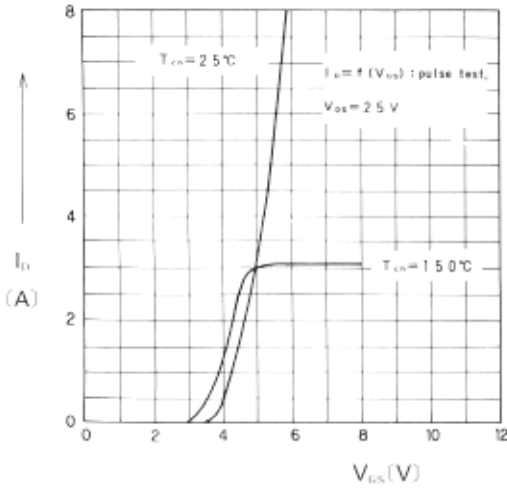

Typical Transfer Characteristics

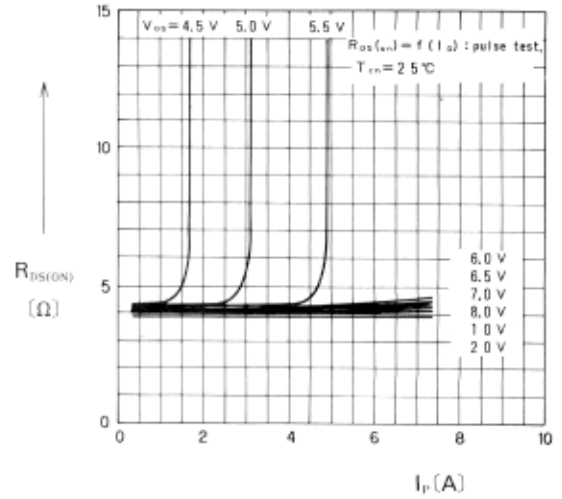

Typical Drain-Source on State Resistance vs. I_D

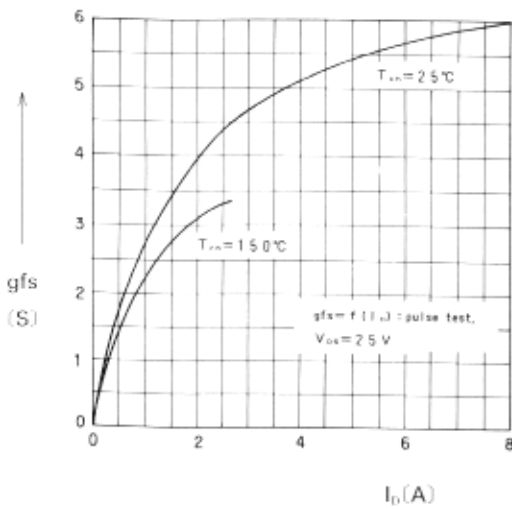

Typical Forward Transconductance vs. I_D

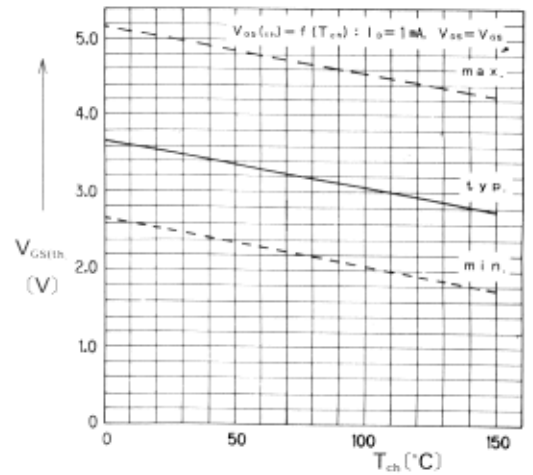

Gate Threshold Voltage vs. T_{ch}

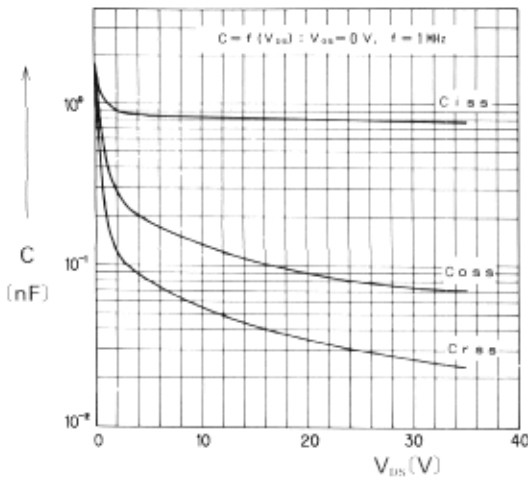

Typical Capacitance vs. V_{DS}

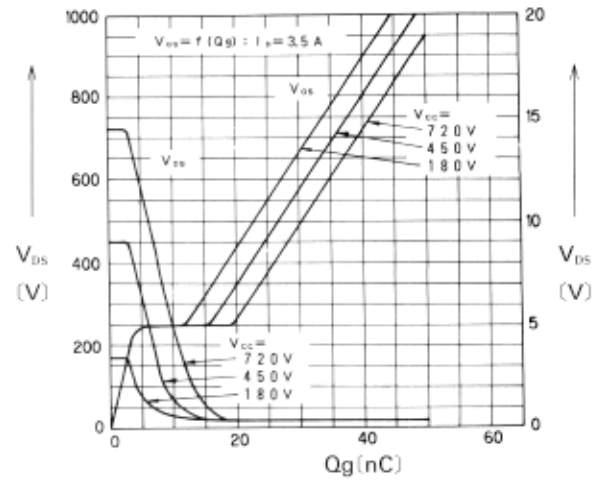

Typical Input Charge

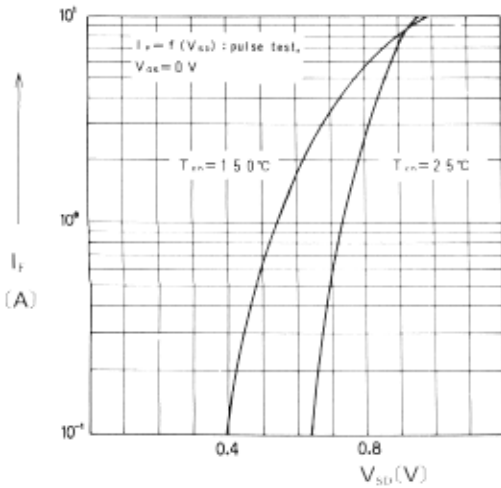

Forward Characteristics of Reverse Diode

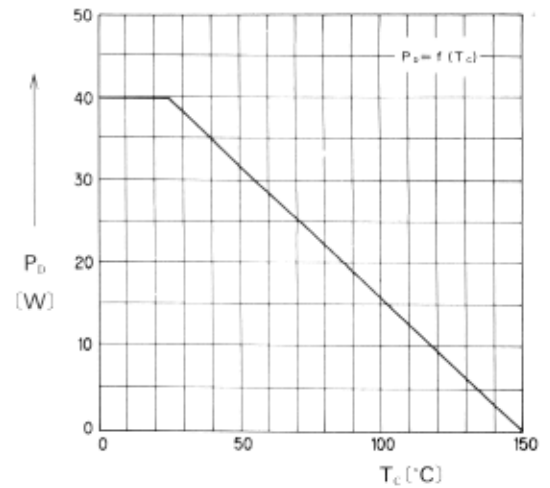

Allowable Power Dissipation vs. T_C

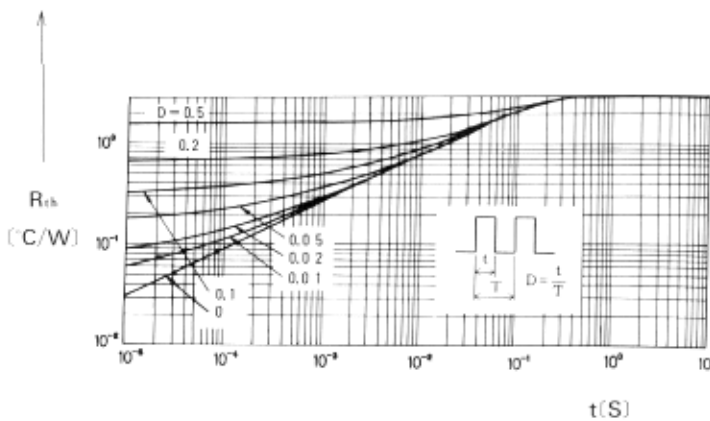

Transient Thermal Impedance

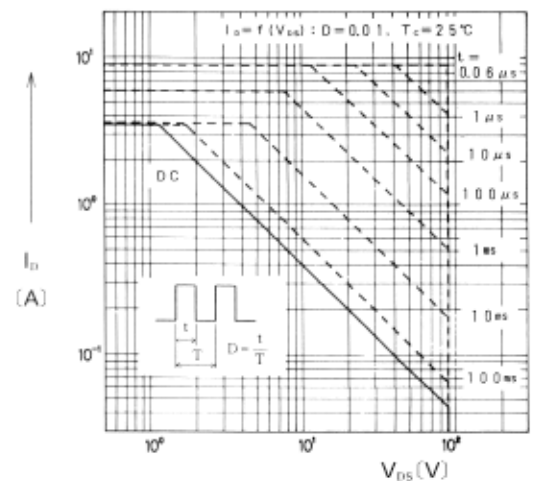

Safe Operating Area