

> **Features**

- High Current
- Low On-Resistance
- No Secondary Breakdown
- Low Driving Power
- High Forward Transconductance

> **Applications**

- Motor Control
- General Purpose Power Amplifier
- DC-DC converters

> **Outline Drawing**

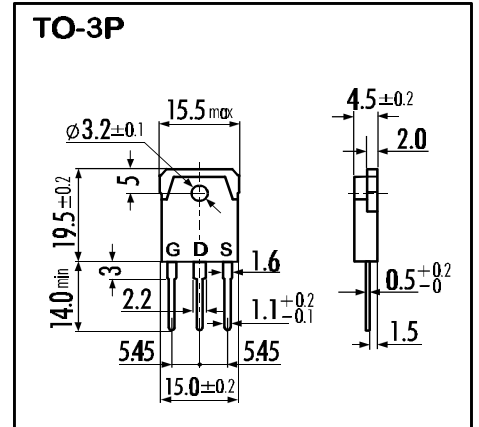

> **Maximum Ratings and Characteristics**

- Absolute Maximum Ratings ($T_C=25^\circ\text{C}$), unless otherwise specified

Item	Symbol	Rating	Unit
Drain-Source-Voltage	V_{DS}	60	V
Continuous Drain Current	I_D	50	A
Pulsed Drain Current	$I_{D(puls)}$	200	A
Continuous Reverse Drain Current	I_{DR}	50	A
Gate-Source-Voltage	V_{GS}	± 20	V
Max. Power Dissipation	P_D	125	W
Operating and Storage Temperature Range	T_{ch}	150	$^\circ\text{C}$
	T_{stg}	-55 ~ +150	$^\circ\text{C}$

> **Equivalent Circuit**

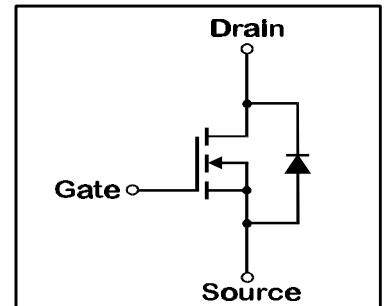

- Electrical Characteristics ($T_C=25^\circ\text{C}$), unless otherwise specified

Item	Symbol	Test conditions	Min.	Typ.	Max.	Unit
Drain-Source Breakdown-Voltage	$V_{(BR)DSS}$	$I_D=1\text{mA}$ $V_{GS}=0\text{V}$	60			V
Gate Threshold Voltage	$V_{GS(th)}$	$I_D=1\text{mA}$ $V_{DS}=V_{GS}$	1,0	1,5	2,5	V
Zero Gate Voltage Drain Current	I_{DSS}	$V_{DS}=60\text{V}$ $T_{ch}=25^\circ\text{C}$		10	500	μA
		$V_{GS}=0\text{V}$ $T_{ch}=125^\circ\text{C}$		0,2	1,0	mA
Gate Source Leakage Current	I_{GSS}	$V_{GS}=\pm 20\text{V}$ $V_{DS}=0\text{V}$		10	100	nA
Drain Source On-State Resistance	$R_{DS(on)}$	$I_D=25\text{A}$ $V_{GS}=4\text{V}$		0,022	0,04	Ω
		$I_D=25\text{A}$ $V_{GS}=10\text{V}$		0,015	0,025	Ω
Forward Transconductance	g_{fs}	$I_D=25\text{A}$ $V_{DS}=25\text{V}$	20	36		S
Input Capacitance	C_{iss}	$V_{DS}=25\text{V}$		2600	3900	pF
Output Capacitance	C_{oss}	$V_{GS}=0\text{V}$		800	1200	pF
Reverse Transfer Capacitance	C_{rss}	$f=1\text{MHz}$		400	600	pF
Turn-On-Time t_{on} ($t_{on}=t_{d(on)}+t_r$)	$t_{d(on)}$	$V_{CC}=30\text{V}$ $I_D=50\text{A}$		20	30	ns
	t_r			130	200	ns
Turn-Off-Time t_{off} ($t_{off}=t_{d(off)}+t_f$)	$t_{d(off)}$	$V_{GS}=10\text{V}$ $R_{GS}=25\ \Omega$		400	600	ns
	t_f			170	250	ns
Diode Forward On-Voltage	V_{SD}	$I_F=2I_{DR}$ $V_{GS}=0\text{V}$ $T_{ch}=25^\circ\text{C}$		1,35	2,0	V
Reverse Recovery Time	t_{rr}	$I_F=I_{DR}$ $V_{GS}=0\text{V}$		100		ns
		$-di_F/dt=100\text{A}/\mu\text{s}$ $T_{ch}=25^\circ\text{C}$				

- Thermal Characteristics

Item	Symbol	Test conditions	Min.	Typ.	Max.	Unit
Thermal Resistance	$R_{th(ch-a)}$	channel to air			35	$^\circ\text{C}/\text{W}$
	$R_{th(ch-c)}$	channel to case			1,0	$^\circ\text{C}/\text{W}$

> Characteristics

Typical Output Characteristics

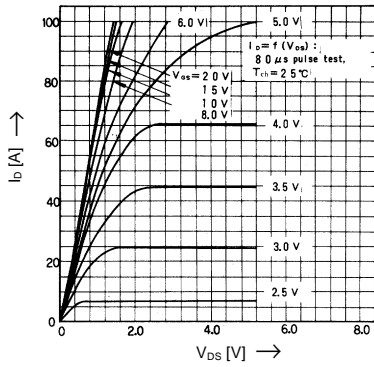

Drain-Source-On-State Resistance vs. T_{ch}

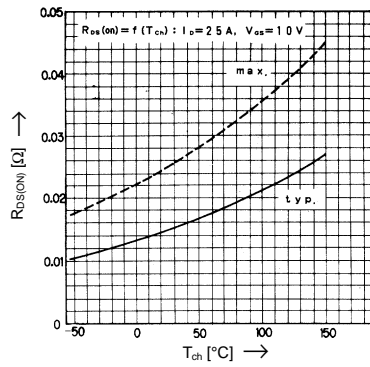

Typical Transfer Characteristics

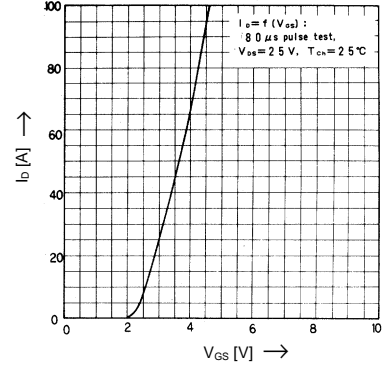

Typical Drain-Source-On-State-Resistance vs. I_D

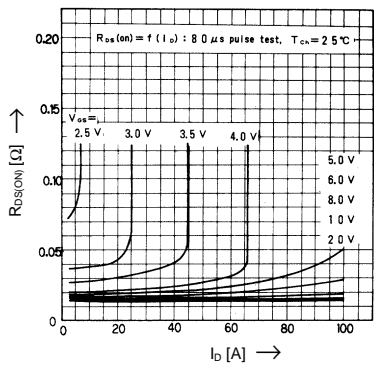

Typical Forward Transconductance vs. I_D

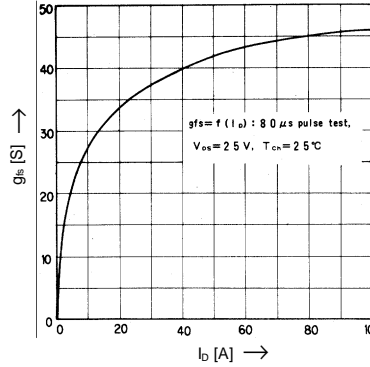

Gate Threshold Voltage vs. T_{ch}

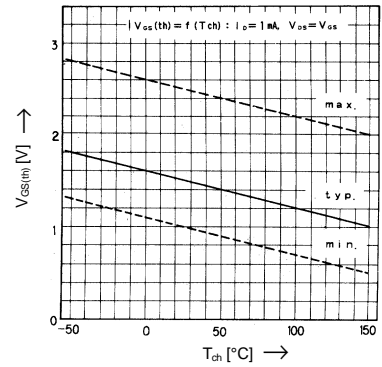

Typical Capacitance vs. V_{DS}

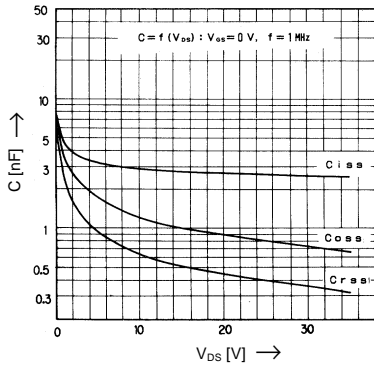

Typical Input Charge

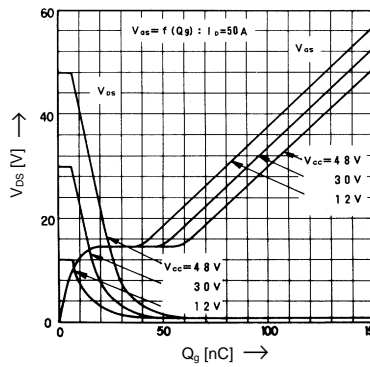

Forward Characteristics of Reverse Diode

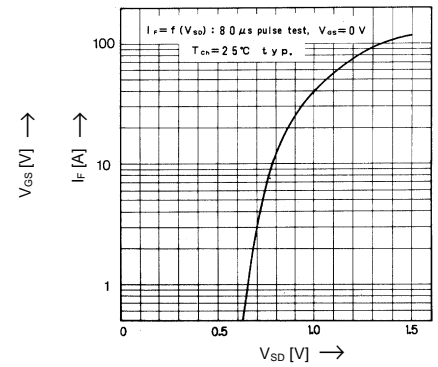

Allowable Power Dissipation vs. T_c

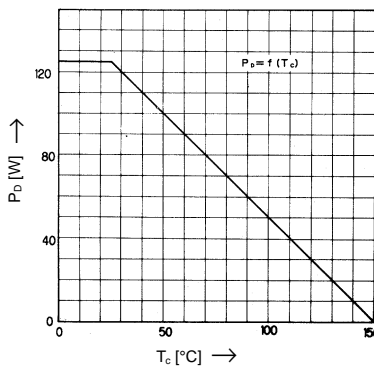

Safe operation area

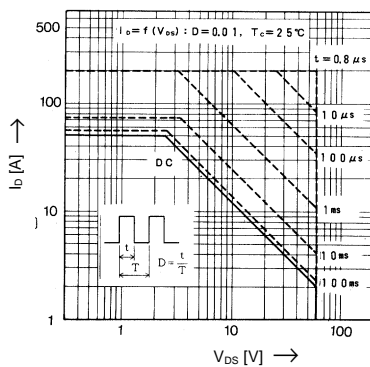

↑

Transient Thermal impedance

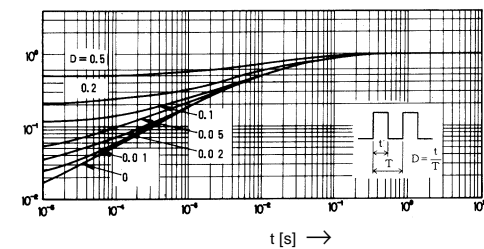

This specification is subject to change without notice!