

**> Features**

- High Current
- Low On-Resistance
- No Secondary Breakdown
- Low Driving Power
- High Forward Transconductance

**> Applications**

- Motor Control
- General Purpose Power Amplifier
- DC-DC converters

**> Outline Drawing**

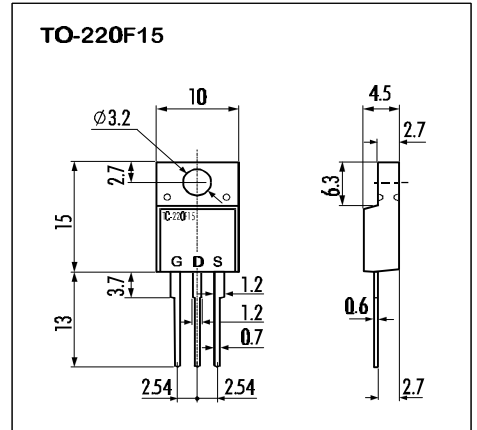

**> Maximum Ratings and Characteristics**

- Absolute Maximum Ratings (T<sub>C</sub>=25°C), unless otherwise specified

Item	Symbol	Rating	Unit
Drain-Source-Voltage	V <sub>DS</sub>	150	V
Continuous Drain Current	I <sub>D</sub>	6	A
Pulsed Drain Current	I <sub>D(puls)</sub>	24	A
Continuous Reverse Drain Current	I <sub>DR</sub>	6	A
Gate-Source-Voltage	V <sub>GS</sub>	±20	V
Max. Power Dissipation	P <sub>D</sub>	30	W
Operating and Storage Temperature Range	T <sub>ch</sub>	150	°C
	T <sub>stg</sub>	-55 ~ +150	°C

**> Equivalent Circuit**

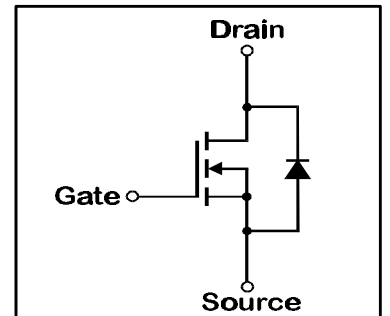

- Electrical Characteristics (T<sub>C</sub>=25°C), unless otherwise specified

Item	Symbol	Test conditions	Min.	Typ.	Max.	Unit
Drain-Source Breakdown-Voltage	V <sub>(BR)DSS</sub>	I <sub>D</sub> =1mA V <sub>GS</sub> =0V	150			V
Gate Threshold Voltage	V <sub>GS(th)</sub>	I <sub>D</sub> =1mA V <sub>DS</sub> =V <sub>GS</sub>	1,0	1,5	2,5	V
Zero Gate Voltage Drain Current	I <sub>DSS</sub>	V <sub>DS</sub> =150V T <sub>ch</sub> =25°C		10	500	μA
		V <sub>GS</sub> =0V T <sub>ch</sub> =125°C		0,2	1,0	mA
Gate Source Leakage Current	I <sub>GSS</sub>	V <sub>GS</sub> =±20V V <sub>DS</sub> =0V		10	100	nA
Drain Source On-State Resistance	R <sub>DS(on)</sub>	I <sub>D</sub> =3A V <sub>GS</sub> =4V		0,40	0,65	Ω
		I <sub>D</sub> =3A V <sub>GS</sub> =10V		0,33	0,50	Ω
Forward Transconductance	g <sub>fs</sub>	I <sub>D</sub> =3A V <sub>DS</sub> =25V	3	6		S
Input Capacitance	C <sub>iss</sub>	V <sub>DS</sub> =25V		600	900	pF
Output Capacitance	C <sub>oss</sub>	V <sub>GS</sub> =0V		100	150	pF
Reverse Transfer Capacitance	C <sub>rss</sub>	f=1MHz		30	45	pF
Turn-On-Time t <sub>on</sub> (t <sub>on</sub> =t <sub>d(on)</sub> +t <sub>r</sub> )	t <sub>d(on)</sub>	V <sub>CC</sub> =30V		10	15	ns
		I <sub>D</sub> =6A		40	60	ns
Turn-Off-Time t <sub>off</sub> (t <sub>off</sub> =t <sub>d(off)</sub> +t <sub>f</sub> )	t <sub>d(off)</sub>	V <sub>GS</sub> =10V		90	120	ns
		R <sub>GS</sub> =25Ω		30	50	ns
Diode Forward On-Voltage	V <sub>SD</sub>	I <sub>F</sub> =2xI <sub>DR</sub> V <sub>GS</sub> =0V T <sub>ch</sub> =25°C		1,01	1,52	V
Reverse Recovery Time	t <sub>rr</sub>	I <sub>F</sub> =I <sub>DR</sub> V <sub>GS</sub> =0V		80		ns
		-dI <sub>F</sub> /dt=100A/μs T <sub>ch</sub> =25°C				

- Thermal Characteristics

Item	Symbol	Test conditions	Min.	Typ.	Max.	Unit
Thermal Resistance	R <sub>th(ch-a)</sub>	channel to air			62,5	°C/W
	R <sub>th(ch-c)</sub>	channel to case			4,17	°C/W

> Characteristics

Typical Output Characteristics

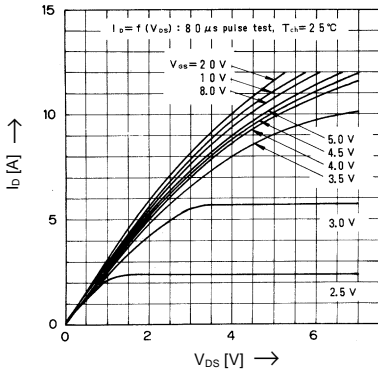

Drain-Source-On-State Resistance vs.  $T_{ch}$

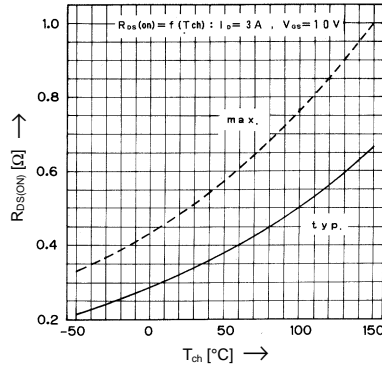

Typical Transfer Characteristics

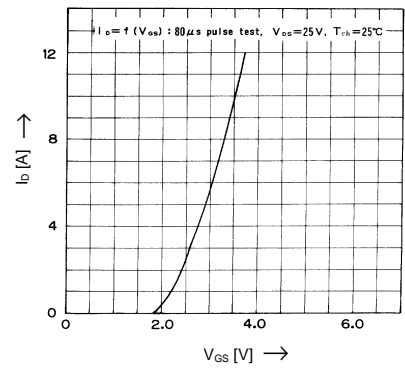

Typical Drain-Source-On-State-Resistance vs.  $I_D$

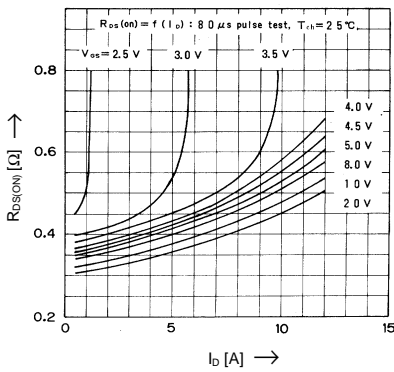

Typical Forward Transconductance vs.  $I_D$

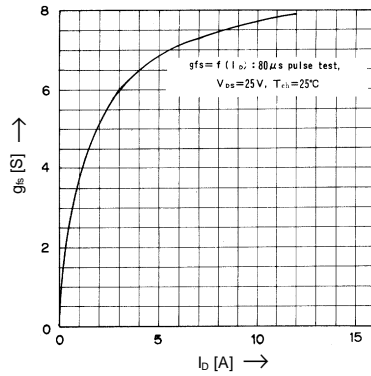

Gate Threshold Voltage vs.  $T_{ch}$

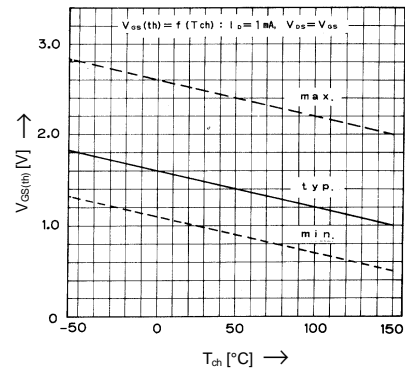

Typical Capacitance vs.  $V_{DS}$

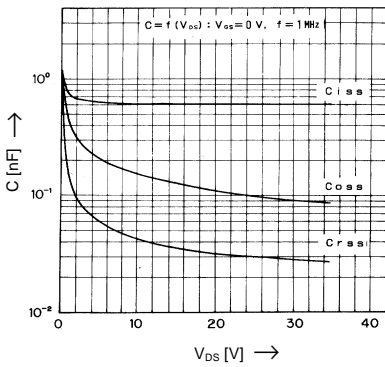

Typical Input Charge

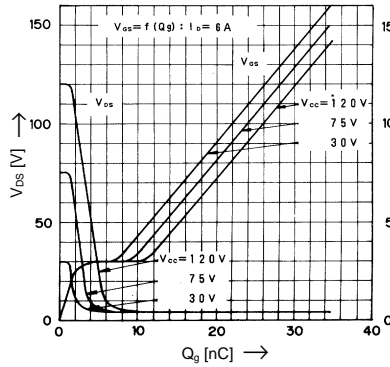

Forward Characteristics of Reverse Diode

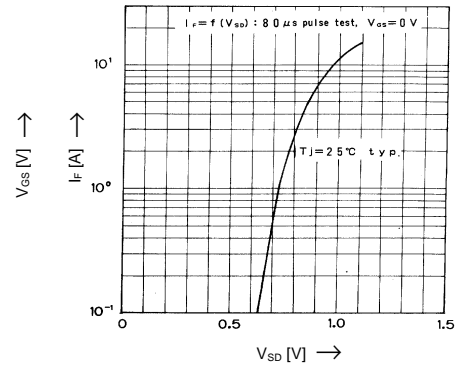

Allowable Power Dissipation vs.  $T_c$

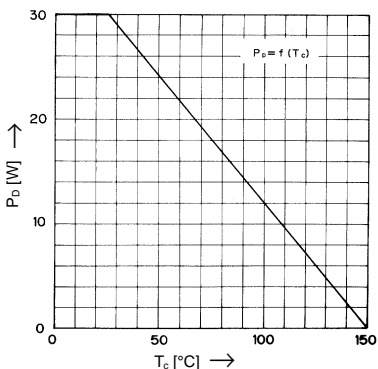

Safe operation area

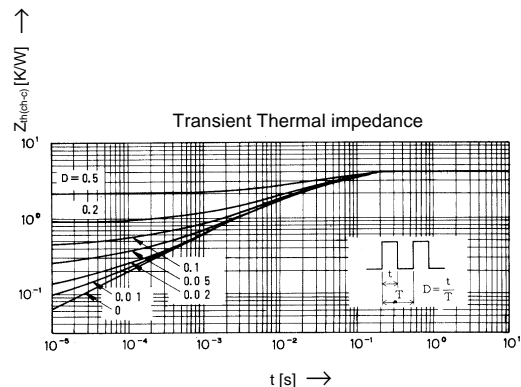
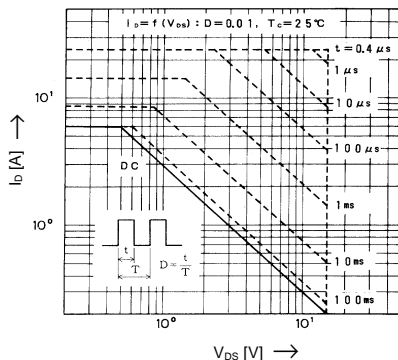

This specification is subject to change without notice!