

# SPECIFICATION

DEVICE NAME : Power MOSFET

TYPE NAME : 2SJ477-01MR

SPEC. NO. :

Fuji Electric Co.,Ltd.

This Specification is subject to change without notice.

	DATE	NAME	APPROVED	<b>Fuji Electric Co.,Ltd.</b>	
DRAWN				DWG. NO.	1/12
CHECKED					

1.Scope This specifies Fuji Power MOSFET 2SJ477-01MR

2.Construction P-Channel enhancement mode power MOSFET

3.Applications for Switching

4.Outview T0-220F Outview See to 5/12 page

5.Absolute Maximum Ratings at Tc=25°C (unless otherwise specified)

Description	Symbol	Characteristics	Unit	Remarks
Drain-Source Voltage	V <sub>DS</sub>	-60	V	
Continuous Drain Current	I <sub>D</sub>	±25	A	
Pulsed Drain Current	I <sub>DP</sub>	±100	A	
Gate-Source Voltage	V <sub>GS</sub>	±20	V	
Maximum Avalanche Energy	E <sub>AV</sub>	519.8	mJ	*1
Maximum Power Dissipation	P <sub>D</sub>	40	W	
Operating and Storage	T <sub>ch</sub>	150	°C	
Temperature range	T <sub>stg</sub>	-55 to +150	°C	

\*1 L=1.11mH, V<sub>CC</sub>=-24V

6.Electrical Characteristics at Tc=25°C (unless otherwise specified)

Static Ratings

Description	Symbol	Conditions	min.	typ.	max.	Unit
Drain-Source Breakdown Voltage	BV <sub>DSS</sub>	I <sub>D</sub> =-1mA V <sub>GS</sub> =0V	-60			V
Gate Threshold Voltage	V <sub>GS(th)</sub>	I <sub>D</sub> =-1mA V <sub>DS</sub> =V <sub>GS</sub>	-1.0	-1.5	-2.5	V
Zero Gate Voltage Drain Current	I <sub>DSS</sub>	V <sub>DS</sub> =-60V T <sub>ch</sub> =25°C		-10	-500	μA
		V <sub>GS</sub> =0V T <sub>ch</sub> =125°C		-0.2	-1.0	mA
Gate-Source Leakage Current	I <sub>GSS</sub>	V <sub>GS</sub> =±20V V <sub>DS</sub> =0V		10	100	nA
Drain-Source On-State Resistance	R <sub>DS(on)</sub>	I <sub>D</sub> =-12.5A	V <sub>GS</sub> =-4V	80	110	mΩ
			V <sub>GS</sub> =-10V	45	60	

### Dynamic Ratings

Description	Symbol	Conditions	min.	typ.	max.	Unit
Forward Transconductance	$g_{fs}$	$I_D = -12.5A$ $V_{DS} = -25V$	7.5	15.0		S
Input Capacitance	$C_{iss}$	$V_{DS} = -25V$		2000	3000	pF
Output Capacitance	$C_{oss}$	$V_{GS} = 0V$		700	1050	
Reverse Transfer Capacitance	$C_{rss}$	$f = 1MHz$		450	680	
Turn-On Time	$t_{d(on)}$	$V_{CC} = -30V$		15	25	ns
	$t_r$	$V_{GS} = -10V$		80	120	
Turn-Off Time	$t_{d(off)}$	$I_D = -25A$		190	290	
	$t_f$	$R_{GS} = 10\Omega$		90	140	

### Reverse Diode

Description	Symbol	Conditions	min.	typ.	max.	Unit
Avalanche Capability	$I_{AV}$	$L = 100\mu H$ $T_{ch} = 25^\circ C$ See Fig.1 and Fig.2	-25			A
Diode Forward On-Voltage	$V_{SD}$	$I_F = 2 \times I_{DR}$ $V_{GS} = 0V$ $T_{ch} = 25^\circ C$		-2	-3	V
Reverse Recovery Time	$t_{rr}$	$I_F = I_{DR}$		160		ns
Reverse Recovery Charge	$Q_{rr}$	$di/dt = 100A/\mu s$ $T_{ch} = 25^\circ C$		0.9		$\mu C$

### 7. Thermal Resistance

Description	Symbol	min.	typ.	max.	Unit
Channel to Case	$R_{th(ch-c)}$			3.125	$^\circ C/W$
Channel to Ambient	$R_{th(ch-a)}$			62.5	$^\circ C/W$

Fig.1 Test circuit

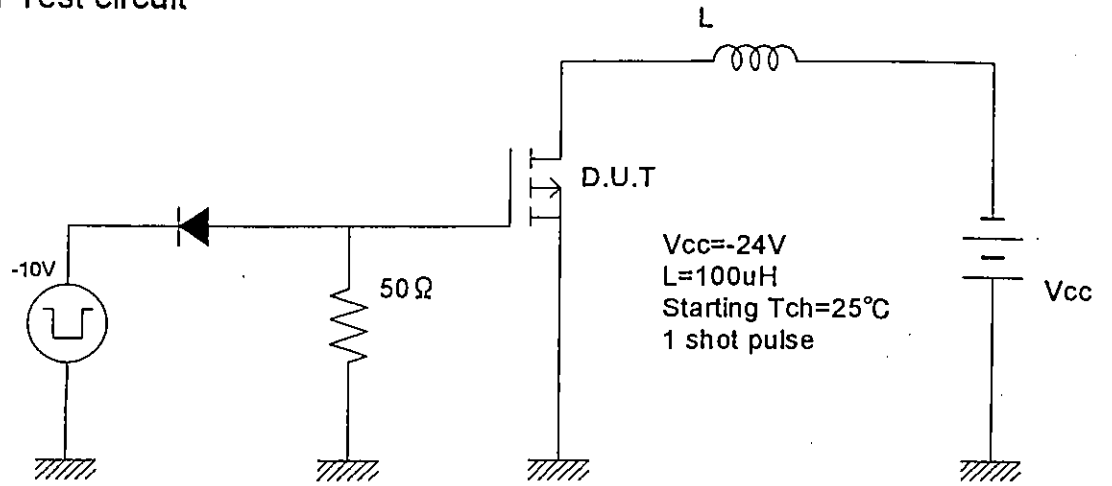
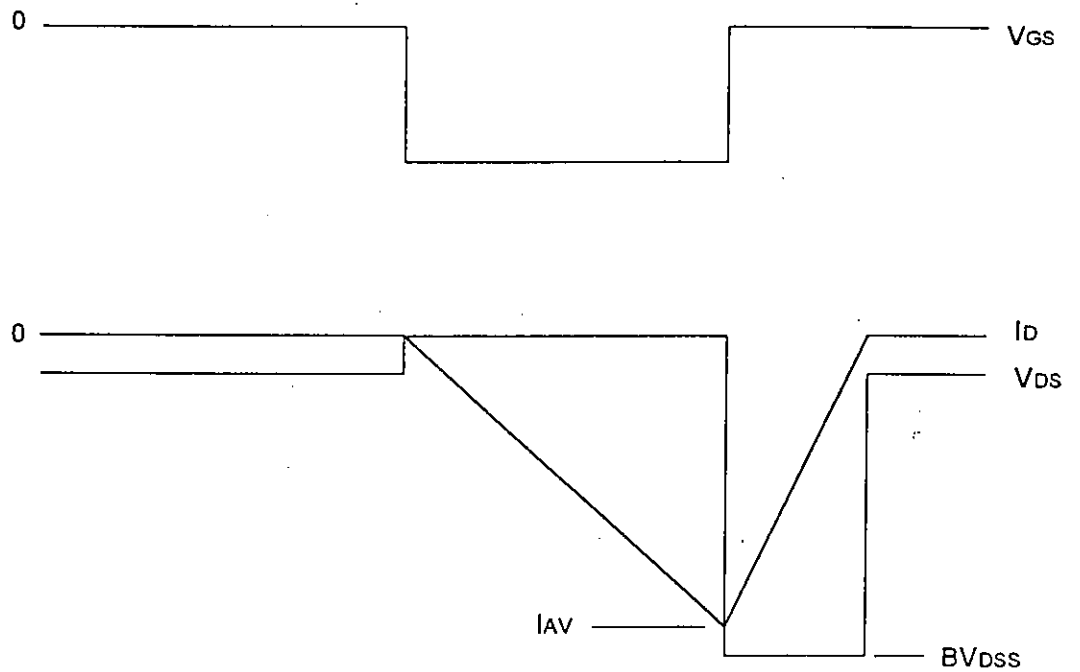
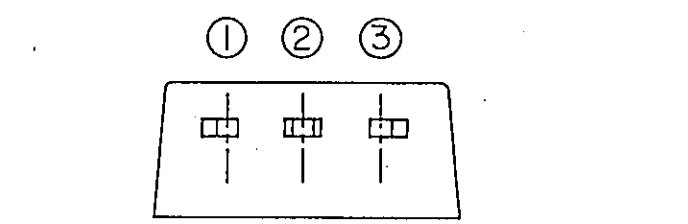
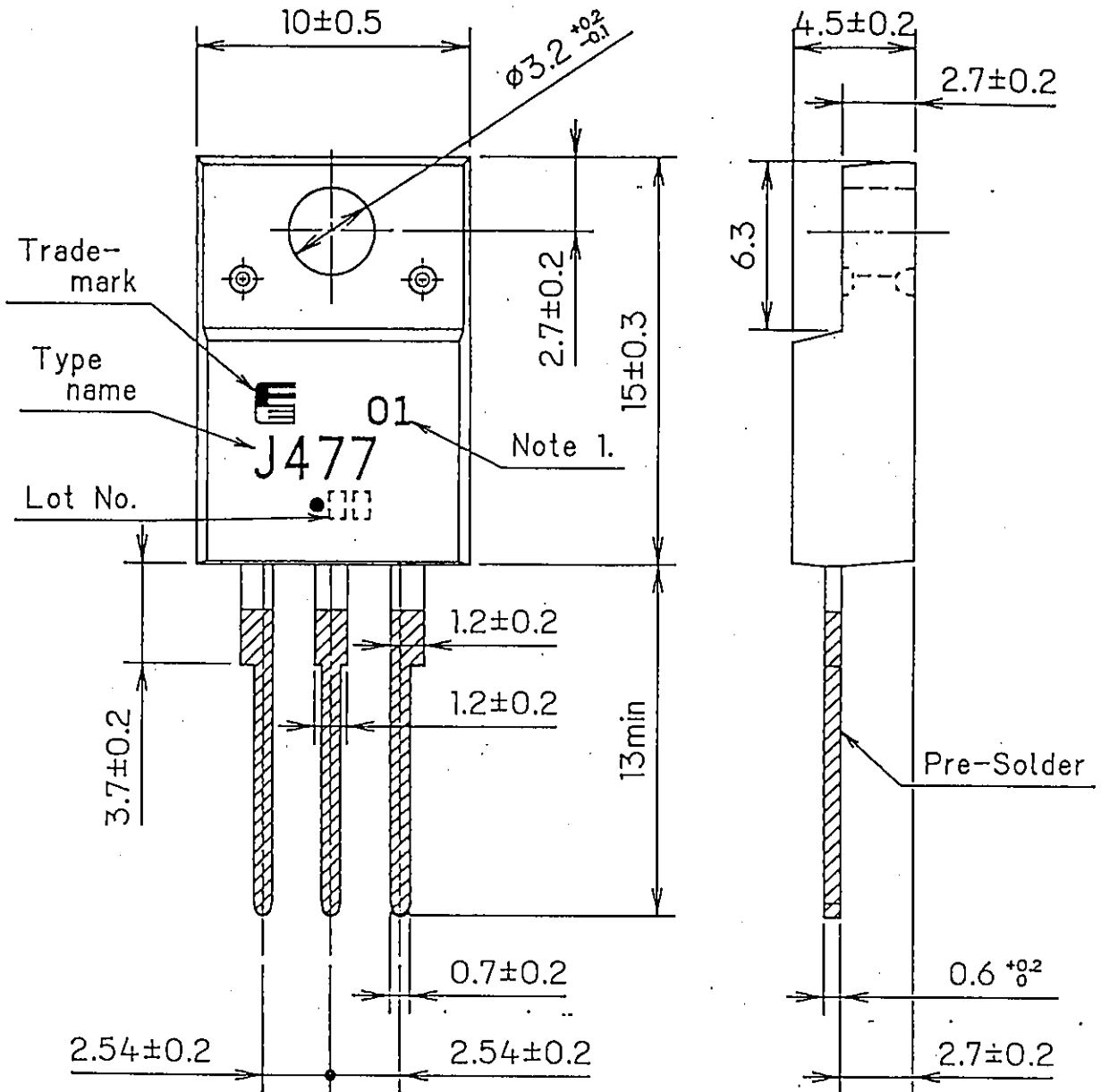

Fig.2 Operating waveforms



FUJI POWER MOS FET

TYPE : 2SJ477-01MR



CONNECTION

- ① GATE
- ② DRAIN
- ③ SOURCE

Note 1. Guaranteed mark of avalanche ruggedness.

DIMENSIONS ARE IN MILLIMETERS.

Fuji Electric Co.,Ltd.

DWG. NO.

5/12

# Power Dissipation

$$PD = f(T_c)$$

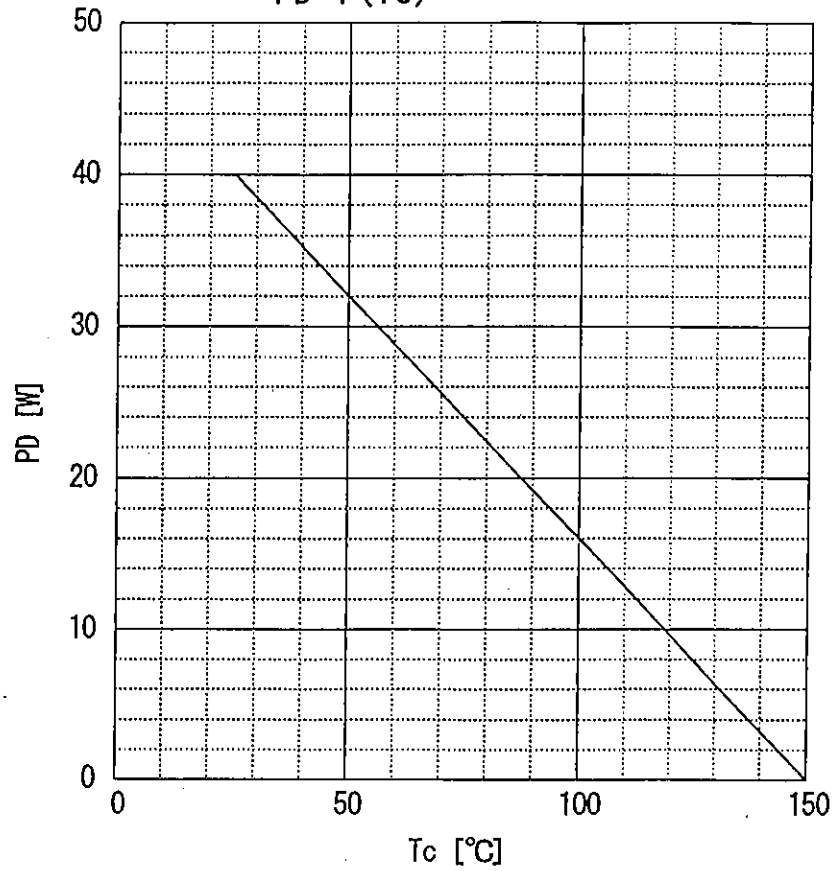

# Safe operating area

$$ID = f(V_{DS}) : D=0.01, T_c=25^\circ C$$

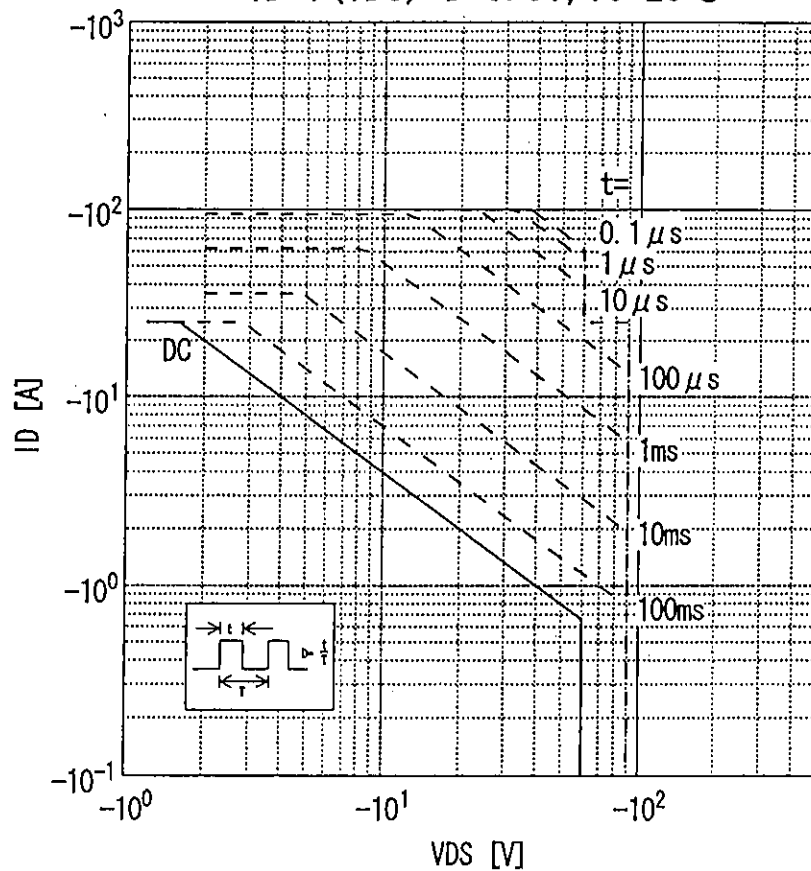

Typical output characteristics  
 $I_D = f(V_{DS})$ : 80  $\mu$ s pulse test,  $T_c = 25^\circ\text{C}$

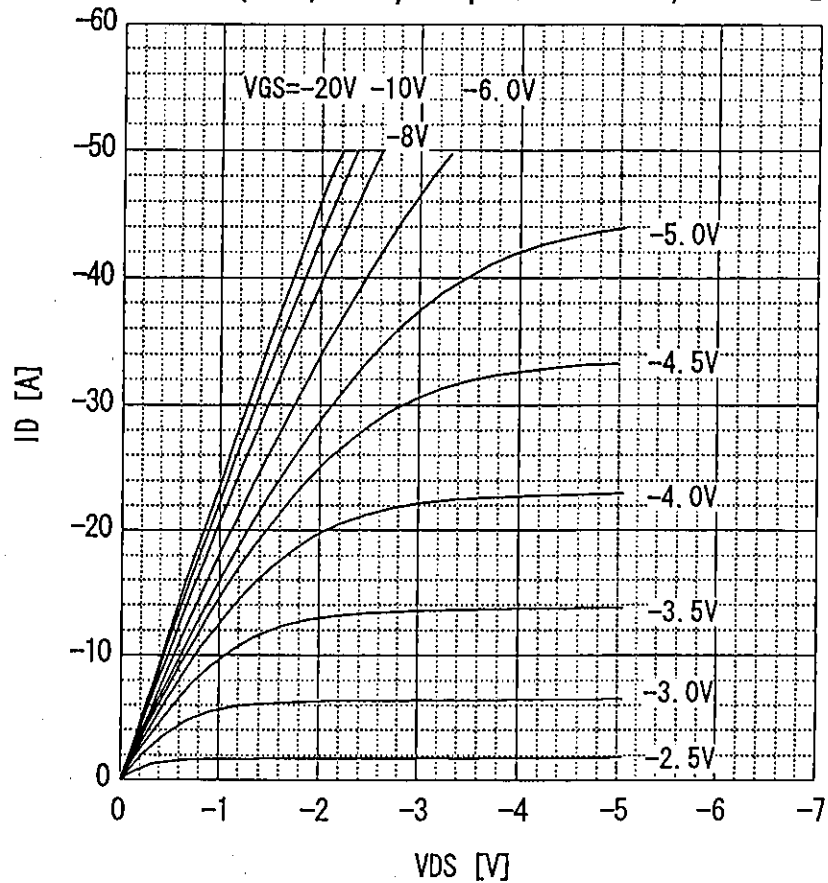

Typical transfer characteristic  
 $I_D = f(V_{GS})$ : 80  $\mu$ s pulse test,  $V_{DS} = -25\text{V}$ ,  $T_{ch} = 25^\circ\text{C}$

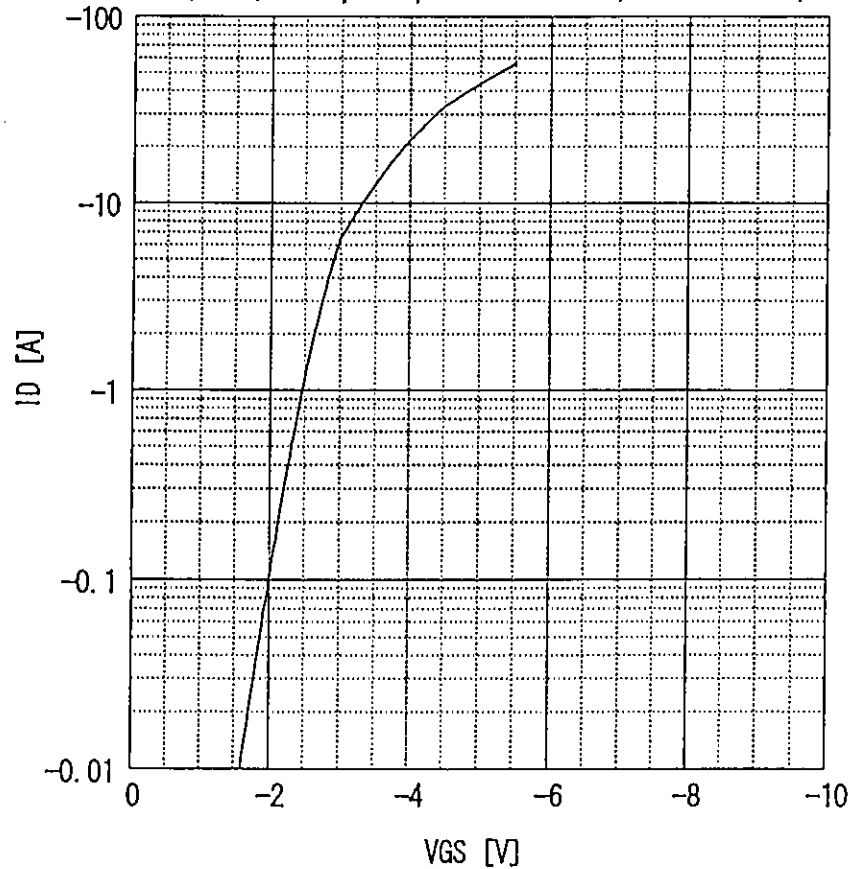

Typical forward transconductance

$g_{fs}=f(I_D)$ : 80  $\mu$ s pulse test,  $V_{DS}=-25V$ ,  $T_{ch}=25^\circ C$

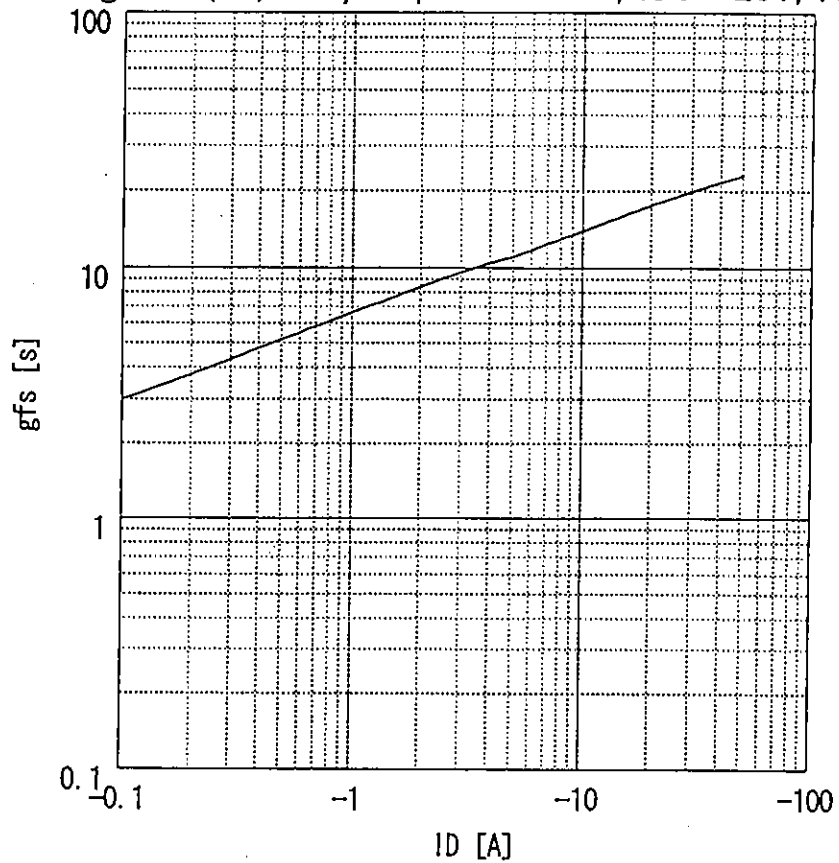

Typical drain-source on-state resistance  
 $R_{DS(on)}=f(I_D)$ : 80  $\mu$ s pulse test,  $T_c=25^\circ C$

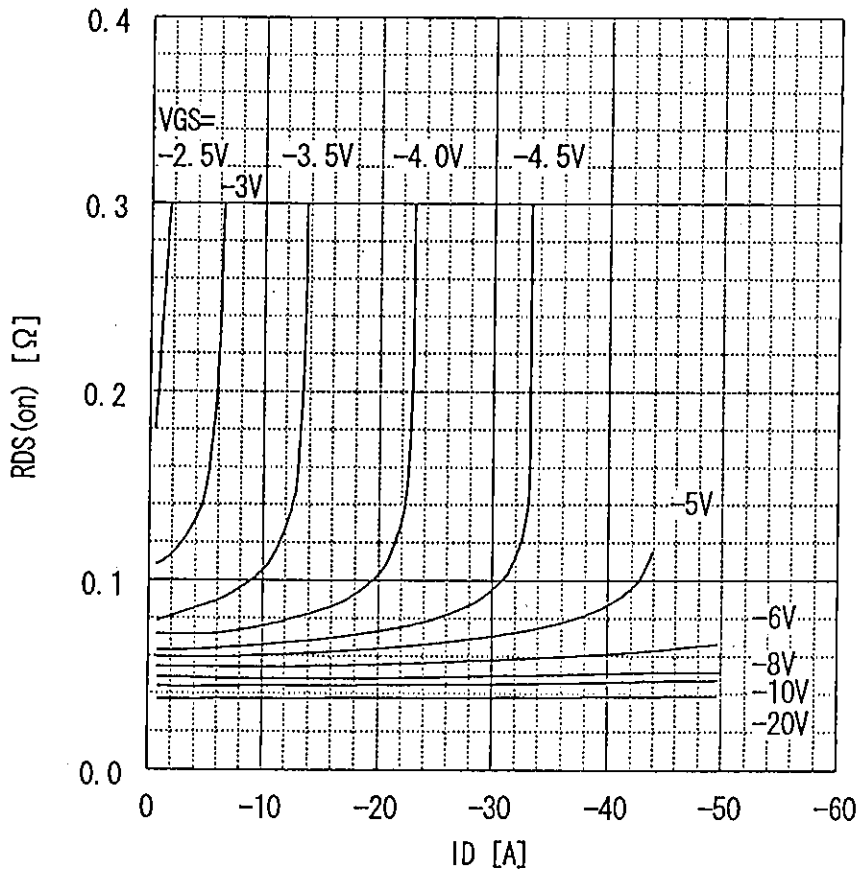



Drain-source on-state resistance  
 $R_{DS(on)} = f(T_{ch}) : I_D = -12.5A, V_{GS} = 10V$

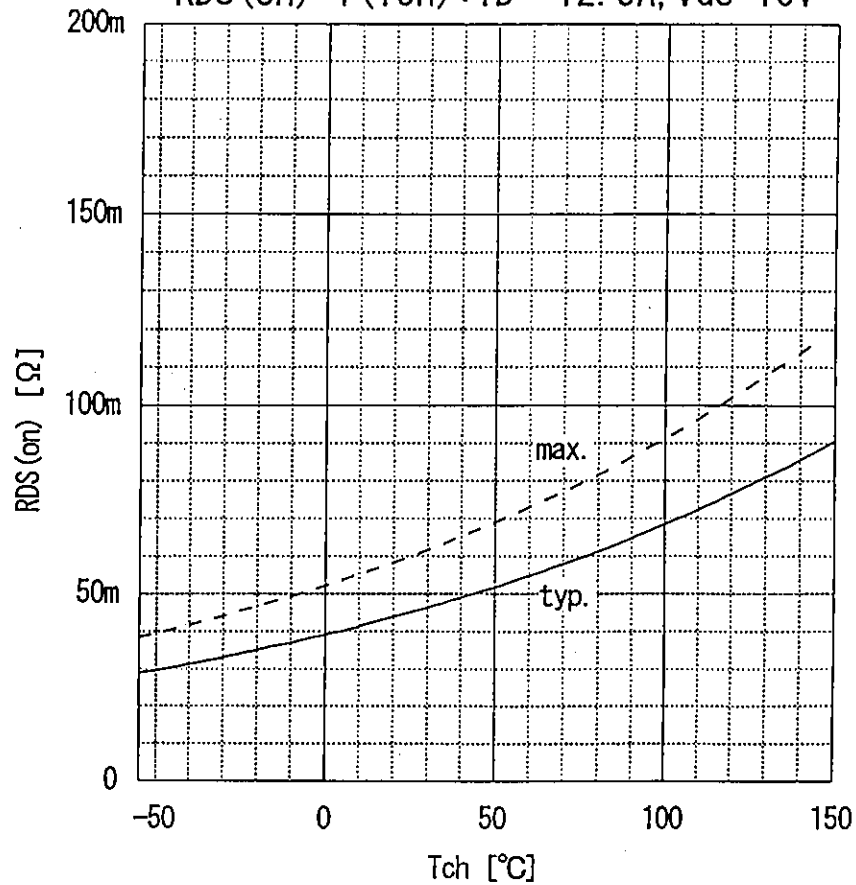

Gate threshold voltage  
 $V_{GS(th)} = f(T_{ch}) : I_D = -1mA, V_{DS} = V_{GS}$

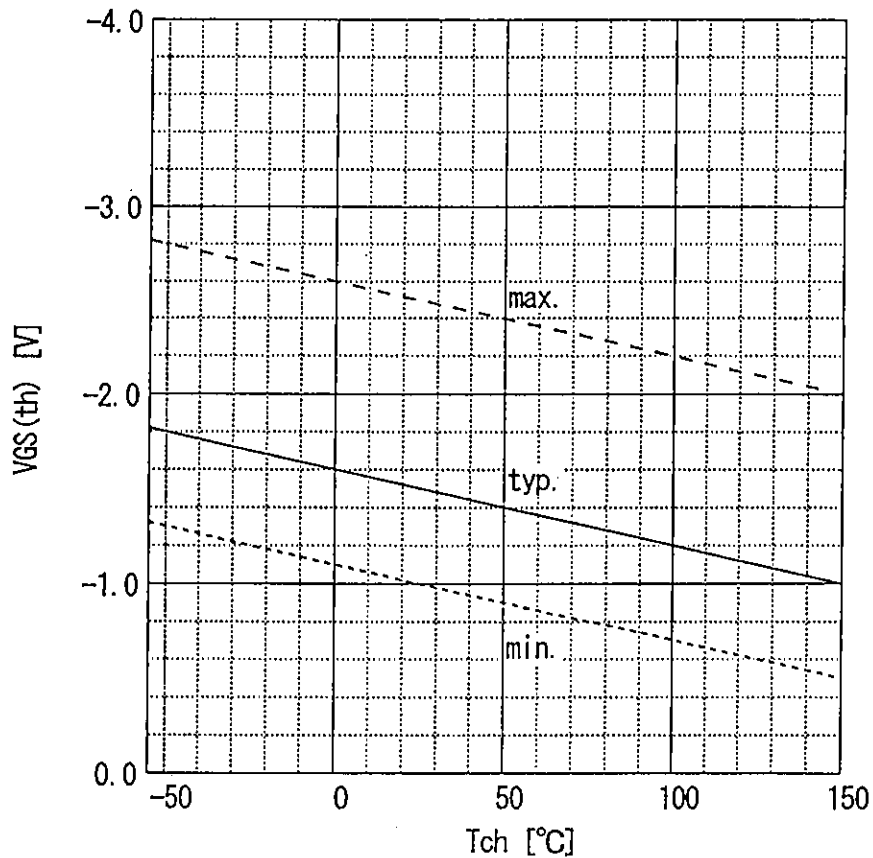

Typical gate charge characteristic  
 $V_{GS} = f(Q_g) : I_D = -25A, T_c = 25^\circ C$

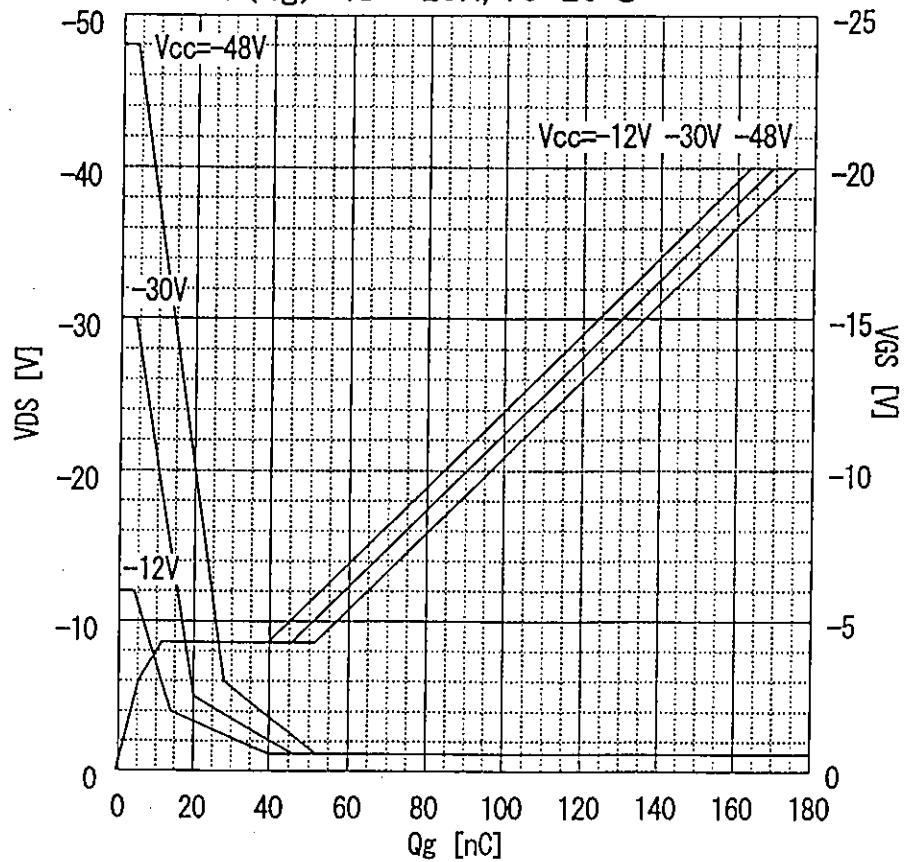

Typical capacitances  
 $C = f(V_{DS}) : V_{GS} = 0V, f = 1MHz$

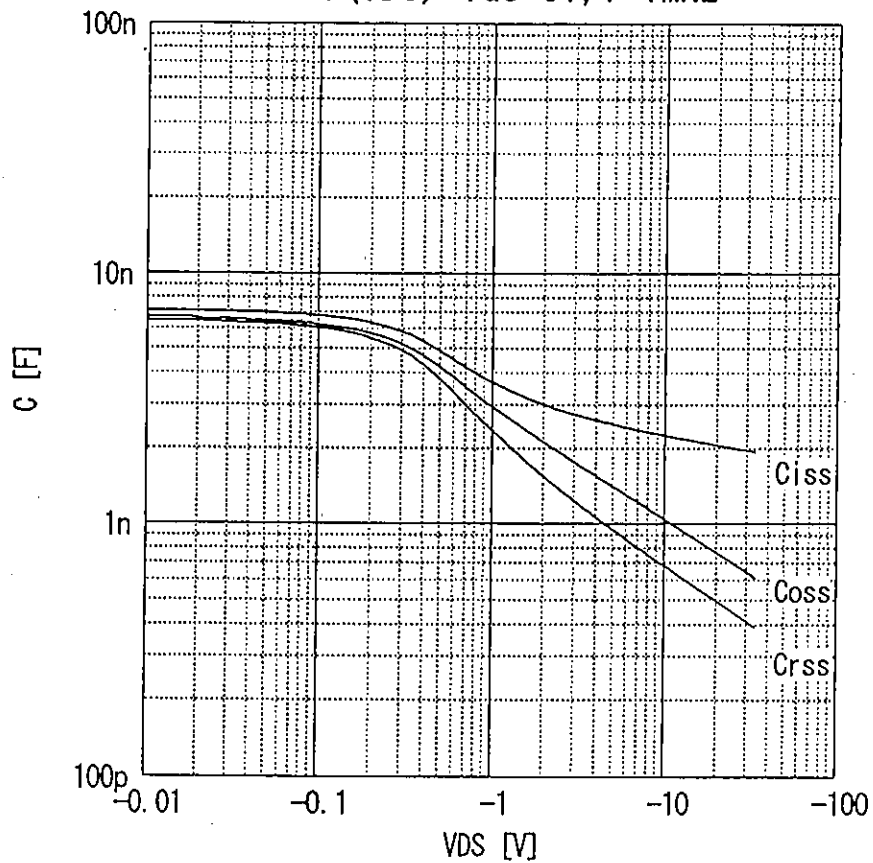

Maximum Avalanche Current vs. starting Tch  
 $I(AV) = f(\text{starting Tch})$

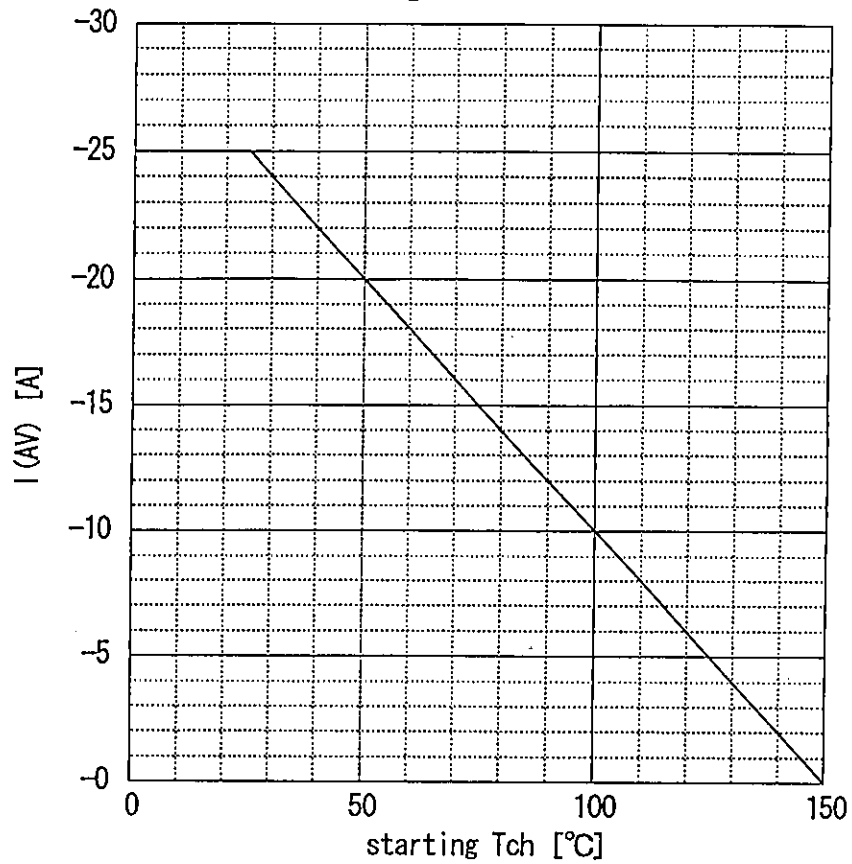

Maximum Avalanche Energy vs. starting Tch  
 $E(AV) = f(\text{starting Tch}) : V_{CC} = -24V, I(AV) \geq -25A$

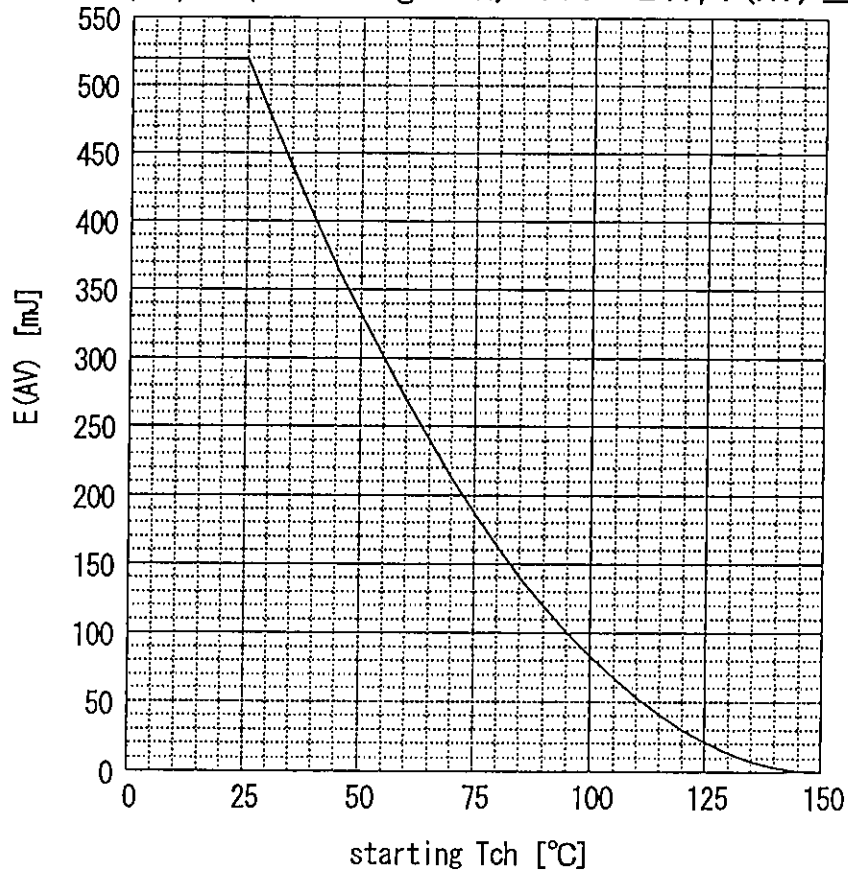

Forward characteristic of reverse of diode  
 $I_F=f(V_{SD}) : 80 \mu s$  pulses test,  $V_{GS}=0V$

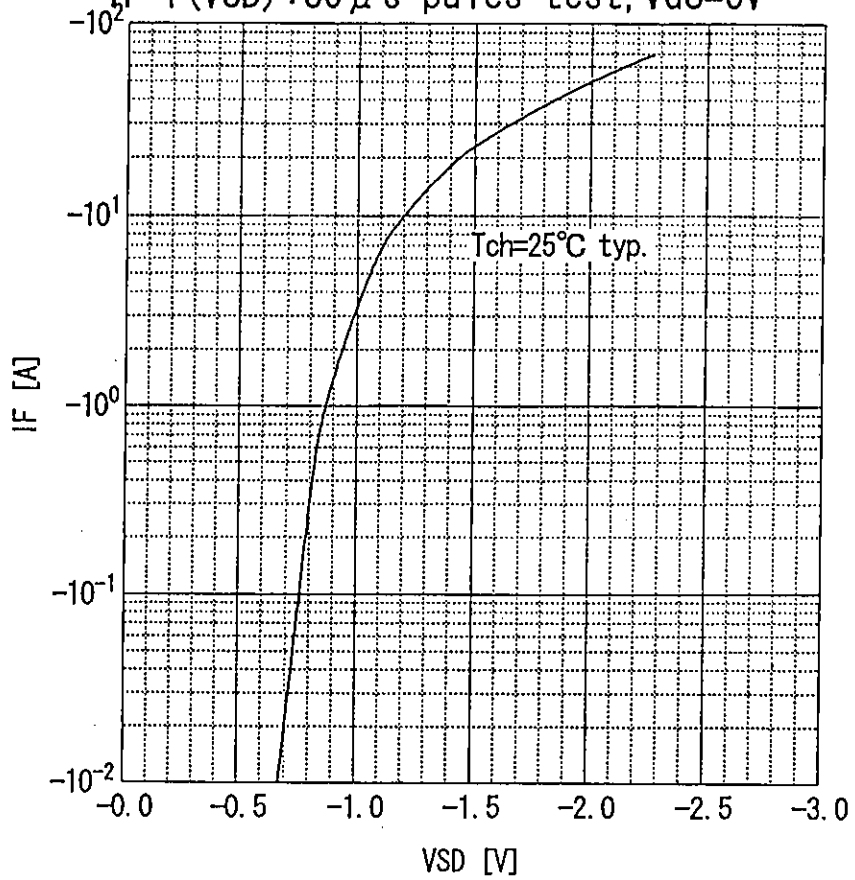

Transient thermal impedande  
 $Z_{thch-c}=f(t)$  parameter:  $D=t/T$

