

Fuji Discrete Package IGBT

■ Outline Drawing

■ Features

- Square RBSOA
- Low Saturation Voltage
- Less Total Power Dissipation
- Minimized Internal Stray Inductance

■ Applications

- High Power Switching
- A.C. Motor Controls
- D.C. Motor Controls
- Uninterruptible Power Supply

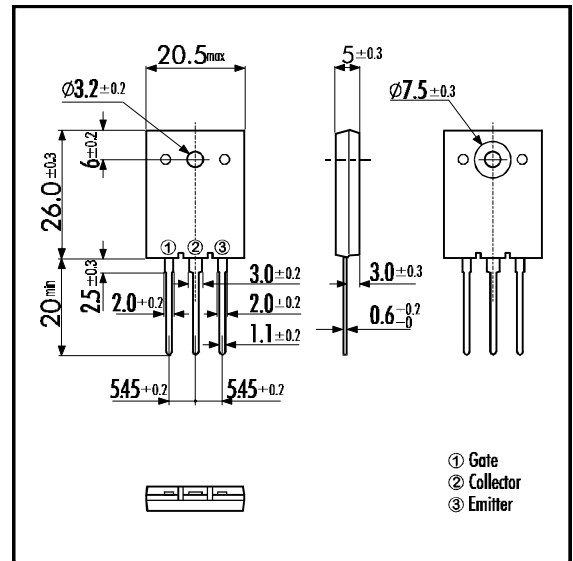

■ Maximum Ratings and Characteristics

• Absolute Maximum Ratings (T_c=25°C)

| Items | Symbols | Ratings | Units |
|-----------------------------|---------------------------|----------------------|-------|
| Collector-Emitter Voltage | V _{CES} | 600 | V |
| Gate -Emitter Voltage | V _{GES} | ± 20 | V |
| Collector Current | DC T _c = 25°C | I _{C 25} | 82 |
| | DC T _c =100°C | I _{C 100} | 50 |
| | 1ms T _c = 25°C | I _{C PULSE} | 328 |
| IGBT Max. Power Dissipation | P _C | 310 | W |
| FWD Max. Power Dissipation | P _C | 140 | W |
| Operating Temperature | T _j | +150 | °C |
| Storage Temperature | T _{stg} | -40 ~ +150 | °C |
| Mounting Screw Torque | | 70 | Nm |

■ Equivalent Circuit

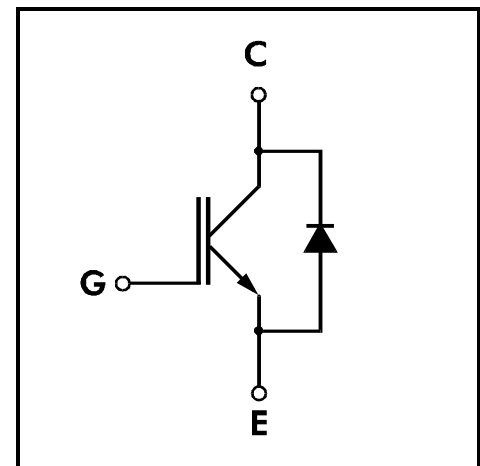

• Electrical Characteristics (at T_j=25°C)

| Items | Symbols | Test Conditions | Min. | Typ. | Max. | Units | |
|--------------------------------------|----------------------|---|-----------------------|------|------|-------|----|
| Zero Gate Voltage Collector Current | I _{CES} | V _{GE} =0V V _{CE} =600V | | | 1.0 | mA | |
| Gate-Emitter Leakage Current | I _{GES} | V _{CE} =0V V _{GE} =± 20V | | | 20 | μA | |
| Gate-Emitter Threshold Voltage | V _{GE(th)} | V _{GE} =20V I _C =50mA | 5.5 | | 8.5 | V | |
| Collector-Emitter Saturation Voltage | V _{CE(sat)} | V _{GE} =15V I _C =50A | | | 3.0 | V | |
| Input capacitance | C _{ies} | V _{GE} =0V | | 3000 | | pF | |
| Output capacitance | C _{oes} | V _{CE} =10V | | 650 | | | |
| Reverse Transfer capacitance | C _{res} | f=1MHz | | 150 | | | |
| Switching Time | Turn-on Time | t _{ON} | V _{CC} =300V | | | 1.2 | μs |
| | | t _r | I _C =50A | | | 0.6 | |
| | Turn-off Time | t _{OFF} | V _{GE} =±15V | | | 1.0 | |
| | | t _f | R _G =62Ω | | | 0.35 | |
| | Turn-on Time | t _{ON} | V _{CC} =300V | | 0.16 | | μs |
| | | t _r | I _C =50A | | 0.11 | | |
| | Turn-off Time | t _{OFF} | V _{GE} =+15V | | 0.30 | | |
| | | t _f | R _G =6Ω | | | 0.35 | |
| Diode Forward On-Voltage | V _F | I _F =50A V _{GE} =0V | | | 3.0 | V | |
| Reverse Recovery Time | t _{rr} | I _F =50A, V _{GE} =-10V, di/dt=100A/μs | | | 300 | ns | |

• Thermal Characteristics

| Items | Symbols | Test Conditions | Min. | Typ. | Max. | Units |
|--------------------|----------------------|-----------------|------|------|------|-------|
| Thermal Resistance | R _{th(i-c)} | IGBT | | | 0.40 | °C/W |
| | R _{th(i-e)} | Diode | | | 0.89 | |

Collector Current vs. Collector-Emittor Voltage

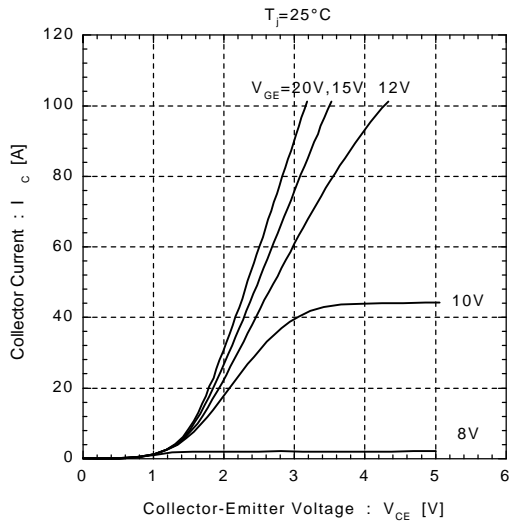

Collector Current vs. Collector-Emittor Voltage

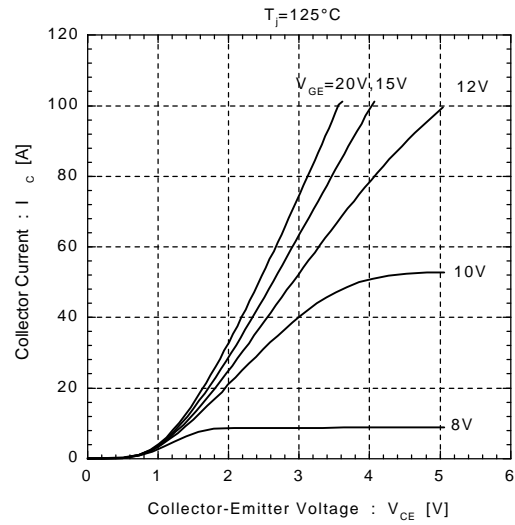

Collector-Emittor Voltage vs. Gate-Emittor Voltage

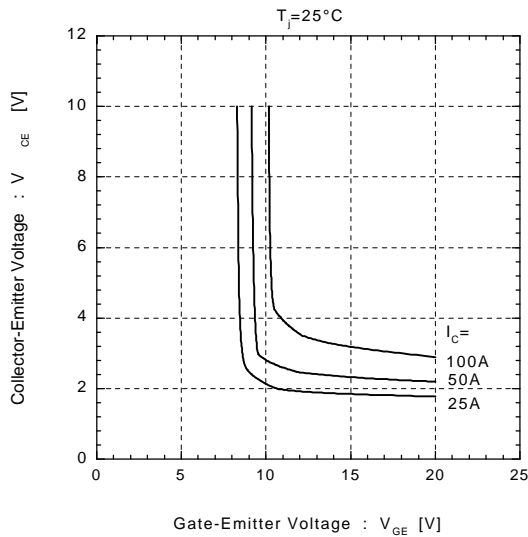

Collector-Emittor Voltage vs. Gate-Emittor Voltage

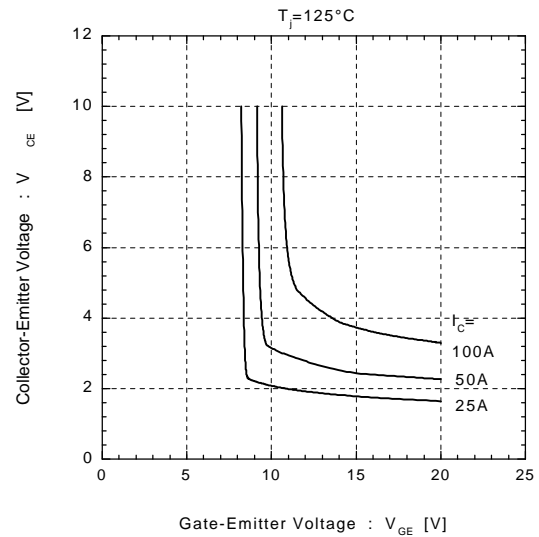

Switching Time vs. Collector Current

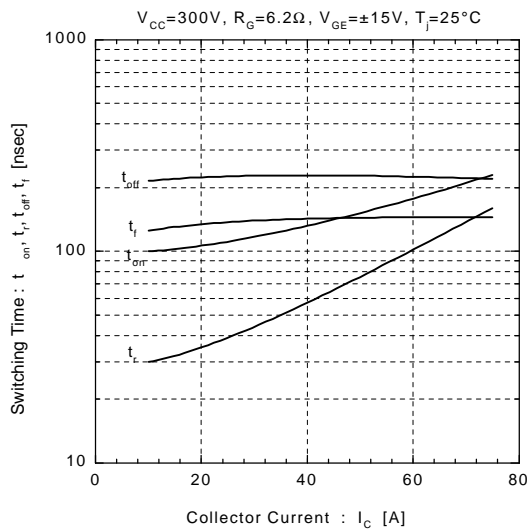

Switching Time vs. Collector Current

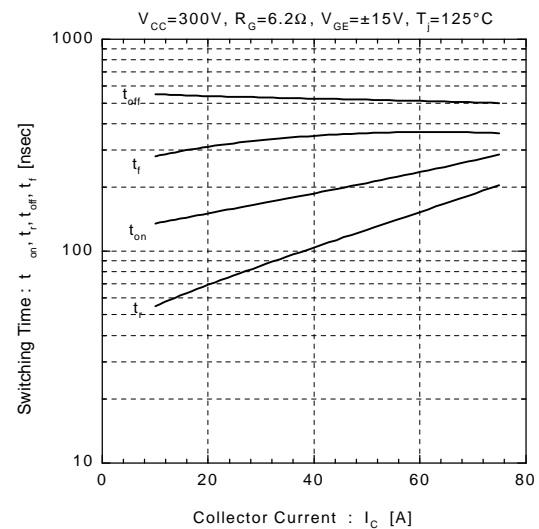

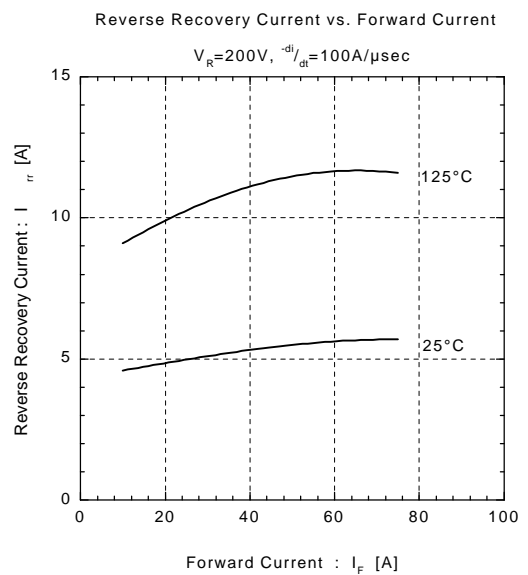
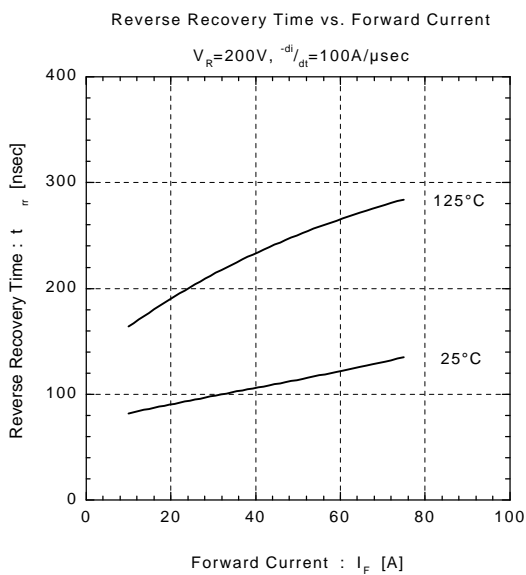
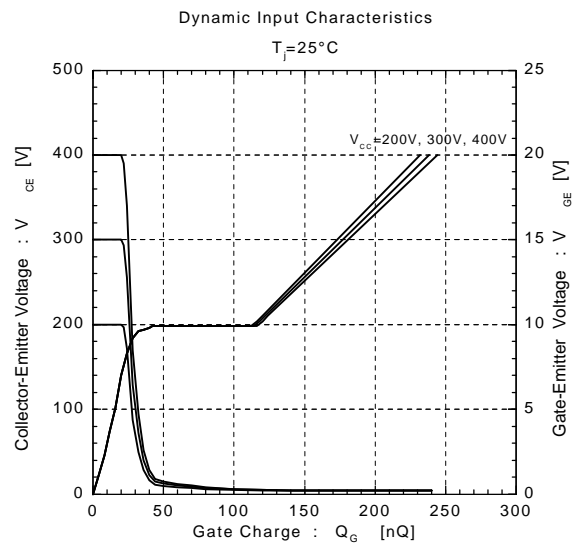
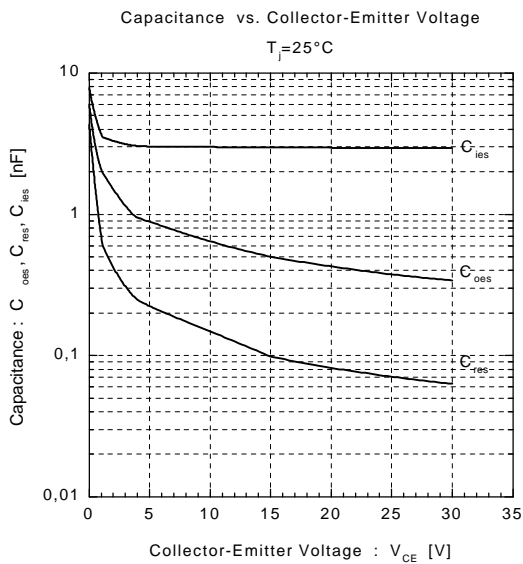
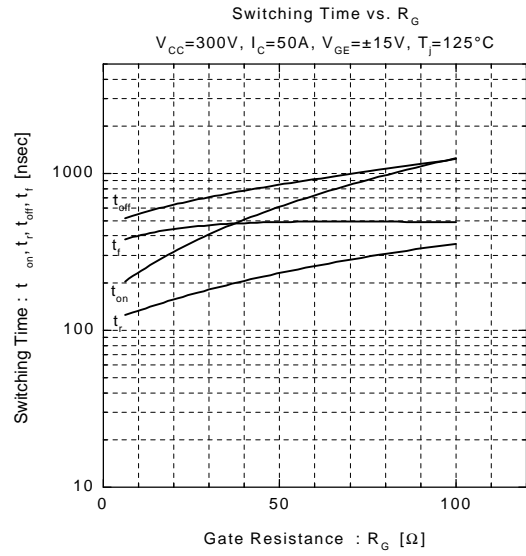
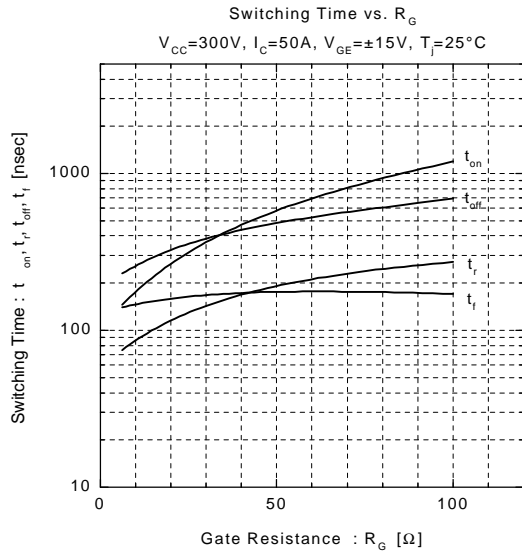

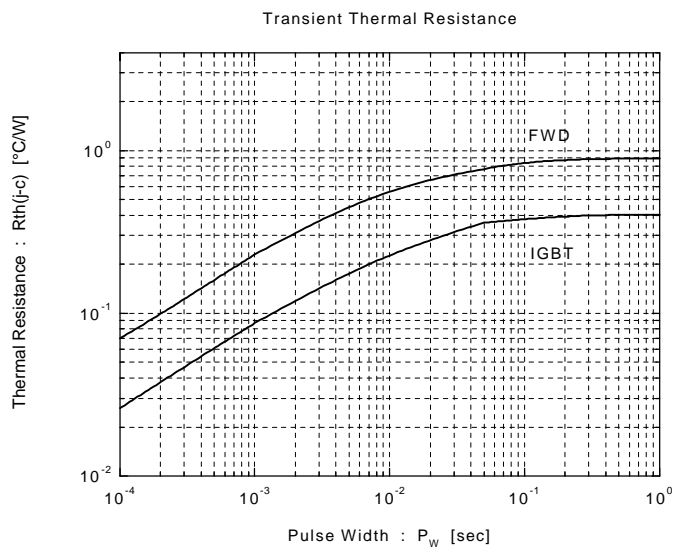
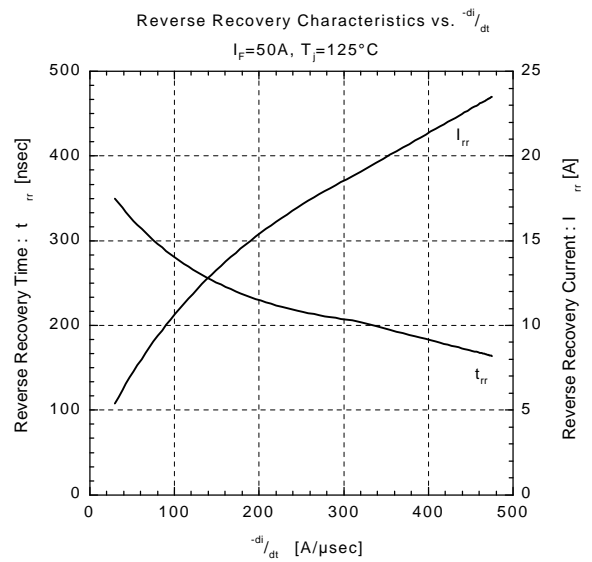
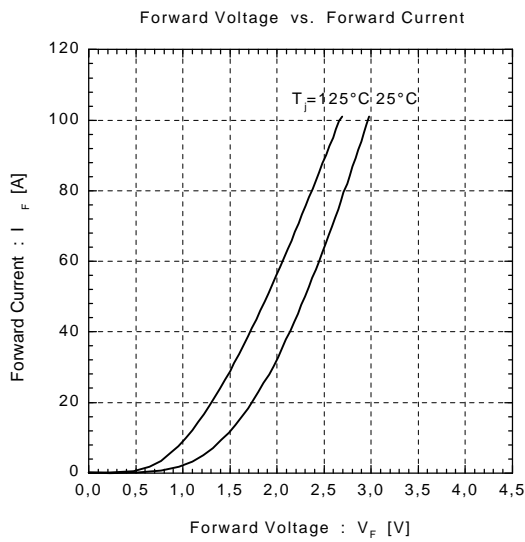
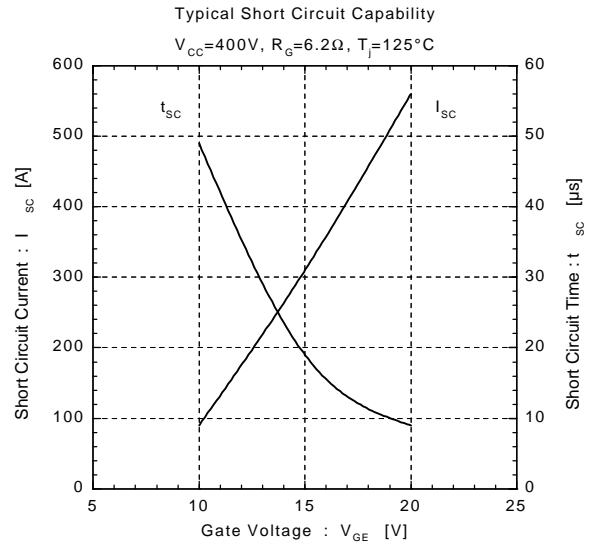
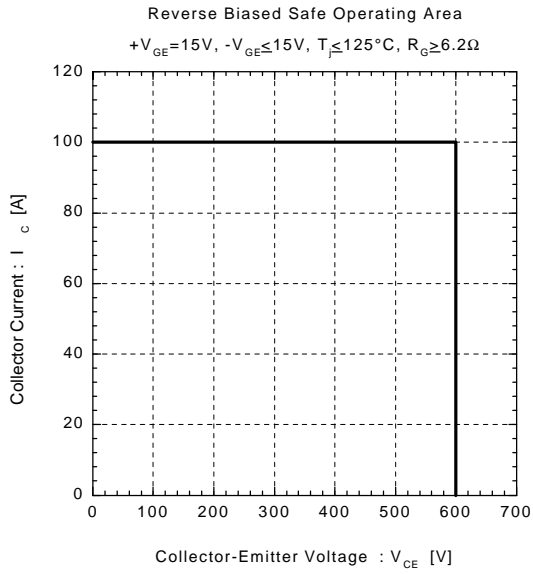

Switching losses (E_{on} , E_{off} vs. I_c)

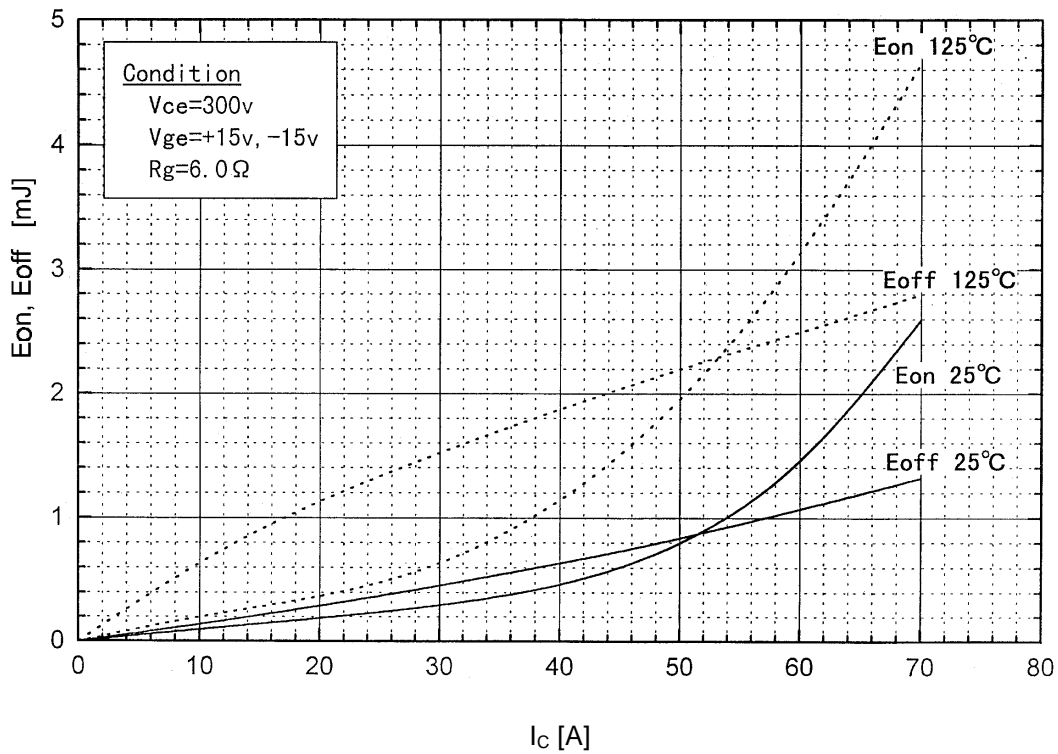

Test Circuit

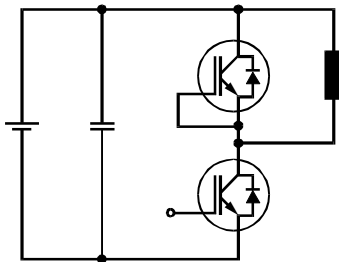

Switching waveforms

