

Fuji Discrete Package IGBT

■ Features

- Square RBSOA
- Low Saturation Voltage
- Less Total Power Dissipation
- Minimized Internal Stray Inductance

■ Applications

- High Power Switching
- A.C. Motor Controls
- D.C. Motor Controls
- Uninterruptible Power Supply

■ Outline Drawing

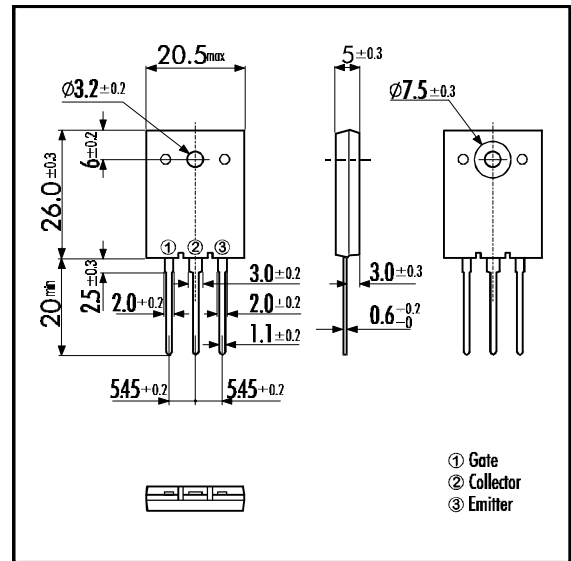

■ Maximum Ratings and Characteristics

• Absolute Maximum Ratings (T_c=25°C)

Items	Symbols	Ratings	Units
Collector-Emitter Voltage	V _{CES}	1200	V
Gate -Emitter Voltage	V _{GES}	± 20	V
Collector Current	DC T _c = 25°C	I _{C 25}	38
	DC T _c =100°C	I _{C 100}	25
	1ms T _c = 25°C	I _{C PULSE}	114
IGBT Max. Power Dissipation	P _C	310	W
Operating Temperature	T _i	+150	°C
Storage Temperature	T _{stg}	-40 ~ +150	°C
Mounting Screw Torque		70	Nm

■ Equivalent Circuit

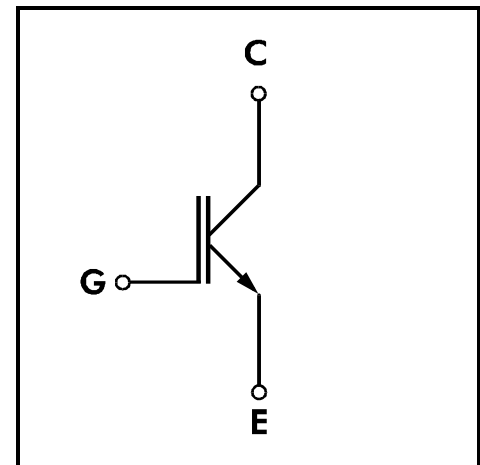

• Electrical Characteristics (at T_f=25°C)

Items	Symbols	Test Conditions	Min.	Typ.	Max.	Units
Zero Gate Voltage Collector Current	I _{CES}	V _{GE} =0V V _{CE} =1200V			1.0	mA
Gate-Emitter Leakage Current	I _{GES}	V _{CE} =0V V _{GE} =± 20V			20	μA
Gate-Emitter Threshold Voltage	V _{GE(th)}	V _{GE} =20V I _C =25mA	5.5		8.5	V
Collector-Emitter Saturation Voltage	V _{CE(sat)}	V _{GE} =15V I _C =25A			3.5	V
Input capacitance	C _{ies}	V _{GE} =0V		2500		pF
Output capacitance	C _{oes}	V _{CE} =10V		500		
Reverse Transfer capacitance	C _{res}	f=1MHz		200		
Switching Time	Turn-on Time	t _{ON}	V _{CC} =600V		1.2	μs
		t _r	I _C =25A		0.6	
	Turn-off Time	t _{OFF}	V _{GE} =±15V		1.5	
		t _f	R _G =82Ω		0.5	
Switching Time	Turn-on Time	t _{ON}	V _{CC} =600V		0.16	μs
		t _r	I _C =25A		0.11	
	Turn-off Time	t _{OFF}	V _{GE} =+15V		0.30	
		t _f	R _G =8Ω		0.5	

• Thermal Characteristics

Items	Symbols	Test Conditions	Min.	Typ.	Max.	Units
Thermal Resistance	R _{th(i-c)}	IGBT			0.40	°C/W

Collector Current vs. Collector-Emittor Voltage

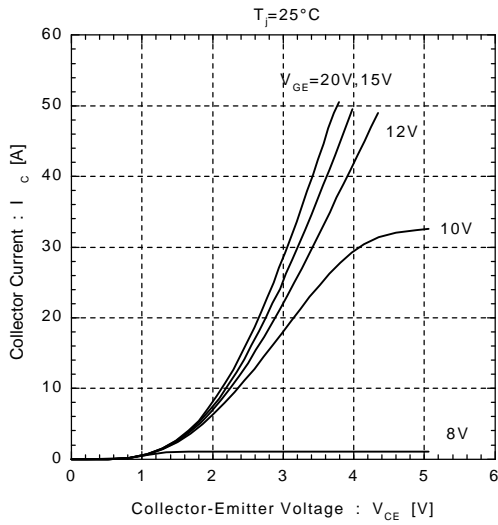

Collector Current vs. Collector-Emittor Voltage

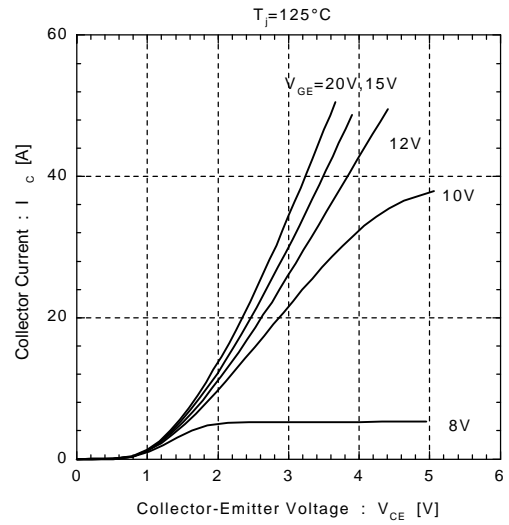

Collector-Emittor Voltage vs. Gate-Emittor Voltage

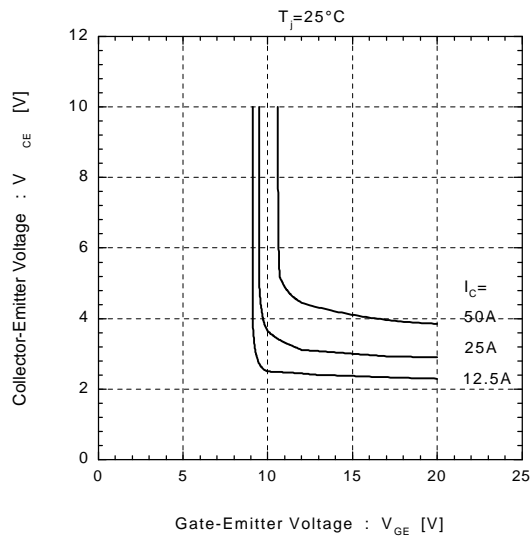

Collector-Emittor Voltage vs. Gate-Emittor Voltage

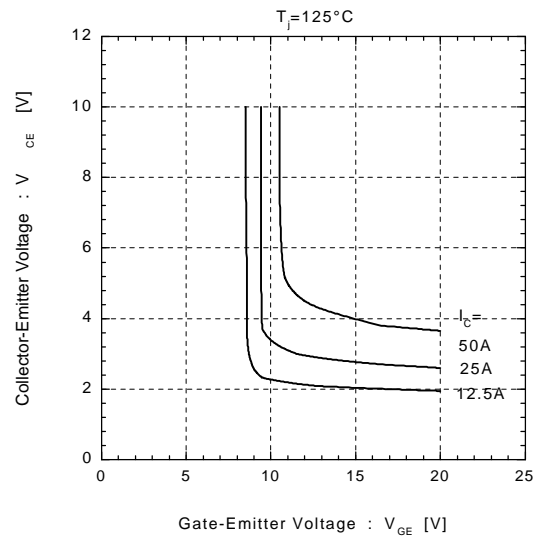

Switching Time vs. Collector Current

$V_{CC}=600V, R_G=8.2\Omega, V_{GE}=\pm 15V, T_J=25^\circ\text{C}$

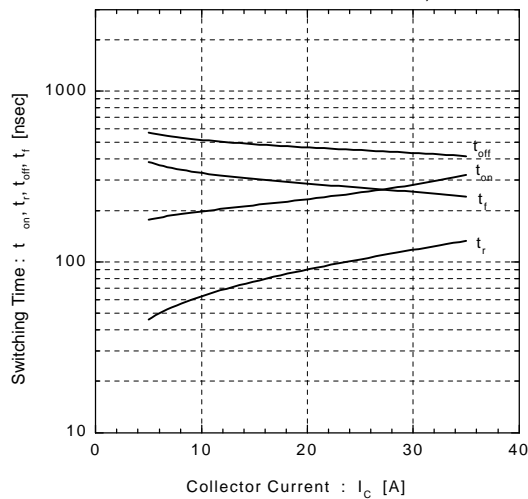

Switching Time vs. Collector Current

$V_{CC}=600V, R_G=8.2\Omega, V_{GE}=\pm 15V, T_J=125^\circ\text{C}$

