

# SPECIFICATION

DEVICE NAME : IGBT  
 TYPE NAME : 1MBH10D-060  
 SPEC. No. :  
 DATE :

Fuji Electric Co.,Ltd.

This Specification is subject to change without notice.

	DATE	NAME	APPROVED	Fuji Electric Co.,Ltd.		
DRAWN				DWG.NO.	1/12	
CHECKED						

Ratings and characteristics of Fuji IGBT

1MBH10D-060

1. Outline Drawing

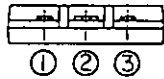
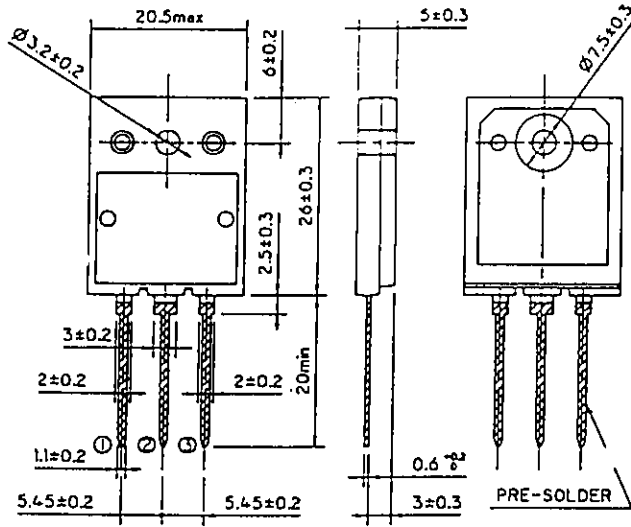

CONNECTION

- ① GATE
- ② COLLECTOR
- ③ EMITTER

2. Equivalent circuit

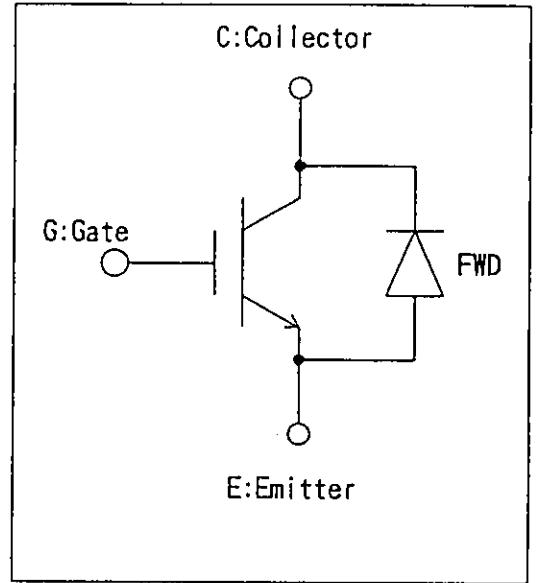

3. Absolute maximum ratings ( Tc=25°C )

Items		Symbols	Ratings	Units	
Collector-Emitter Voltage		$V_{CES}$	600	V	
Gate-Emitter Voltage		$V_{GEE}$	±20	V	
Collector Current	DC	Tc=25 °C	$I_{C25}$	30	A
		Tc=115°C	$I_{C115}$	10	A
	1ms	Tc=25 °C	$I_{cp}$	80	A
IGBT Max. Power Dissipation		$P_c$	115	W	
FWD Max. Power Dissipation		$P_c$	55	W	
Operating Temperature		$T_j$	+ 150	°C	
Storage Temperature		$T_{stg}$	-40 ~ +150	°C	
Mounting Screw Torque		—	70	N · cm	

4. Electrical Characteristics ( at Tc=25°C unless otherwise specified )

Items	Symbols	Characteristics			Conditions	Unit	
		min.	typ.	max.			
Zero gate voltage Collector Current	$I_{CES}$			1.0	$V_{GE} = 0V$ $V_{CE} = 600V$	mA	
Gate-Emitter leakage Current	$I_{GES}$			20	$V_{CE} = 0V$ $V_{GE} = \pm 20V$	$\mu A$	
Gate-Emitter Threshold Voltage	$V_{GE(th)}$	5.5		8.5	$V_{CE} = 20V$ $I_C = 10mA$	V	
Collector-Emitter Saturation Voltage	$V_{CE(sat)}$			3.0	$V_{GE} = 15V$ $I_C = 10A$	V	
Input capacitance	$C_{ies}$		700		$V_{GE} = 0V$	pF	
Output capacitance	$C_{oes}$		150		$V_{CE} = 10V$		
Reverse transfer capacitance	$C_{res}$		20		$f = 1MHz$		
Switching Time	Turn-on time	$t_{on}$		1.2	$V_{CC} = 300V$ $I_C = 10A$ $V_{GE} = \pm 15V$ $R_G = 220\Omega$ (Half Bridge)	$\mu s$	
		$t_r$		0.6			
	Turn-off time	$t_{off}$		1.0			
		$t_f$		0.35			
	Turn-on time	$t_{on}$		0.16			$V_{CC} = 300V$ $I_C = 10A$ $V_{GE} = +15V$ $R_G = 22\Omega$ (Half Bridge)
		$t_r$		0.11			
Turn-off time	$t_{off}$		0.30				
	$t_f$		0.35				
FWD forward voltage drop	$V_F$			3.0	$I_F = 10A$	V	
Reverse recovery time	$t_{rr}$			0.3	$I_F = 10A, V_{GE} = -10V$ $V_R = 200V$ $di/dt = 100A/\mu s$	$\mu s$	

5. Thermal resistance characteristics

Items	Symbols	Characteristics			Conditions	Unit
		min.	typ.	max.		
Thermal resistance	$R_{th(j-c)}$			1.08	IGBT	$^{\circ}C/W$
	$R_{th(j-c)}$			2.27	FWD	

Fuji Electric Co.,Ltd

DWG.NO.

3/12

H04-004-03

This material and the information herein is the property of Fuji Electric Co. Ltd. They shall be neither reproduced, copied, lent, or disclosed in any way whatsoever for the use of any third party nor used for the manufacturing purposes without the express written consent of Fuji Electric Co., Ltd.

Collector Current vs. Collector-Emitter Voltage  
 $T_j=25^\circ\text{C}$

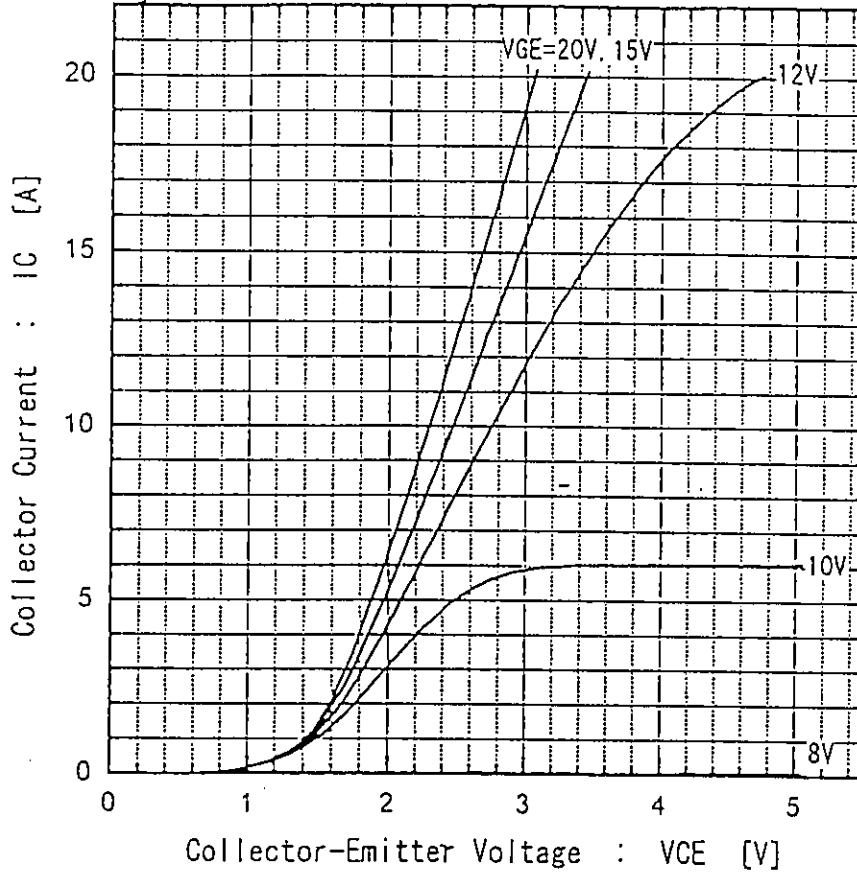

Collector Current vs. Collector-Emitter Voltage  
 $T_j=125^\circ\text{C}$

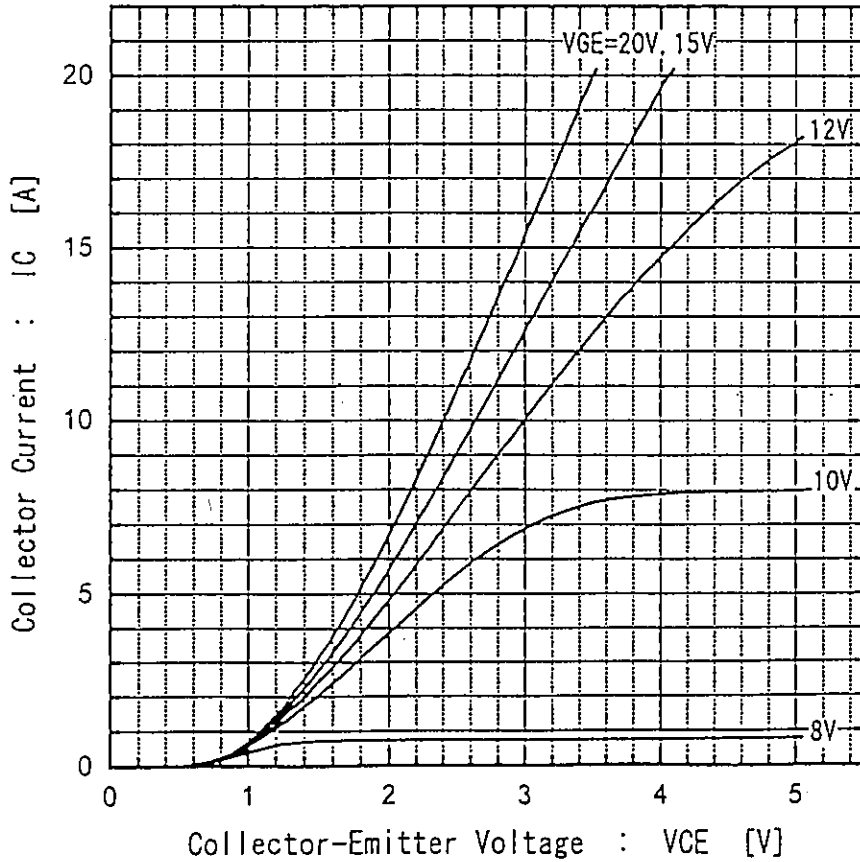

Fuji Electric Co., Ltd.

DWG. NO.

4/12

H04-004-03

This material and the information herein is the property of Fuji Electric Co., Ltd. They shall be neither reproduced, copied, lent, or disclosed in any way whatsoever for the use of any third party nor used for the manufacturing purposes without the express written consent of Fuji Electric Co., Ltd.

Collector-Emitter Voltage vs Gate-Emitter Voltage  
 $T_j=25^\circ\text{C}$

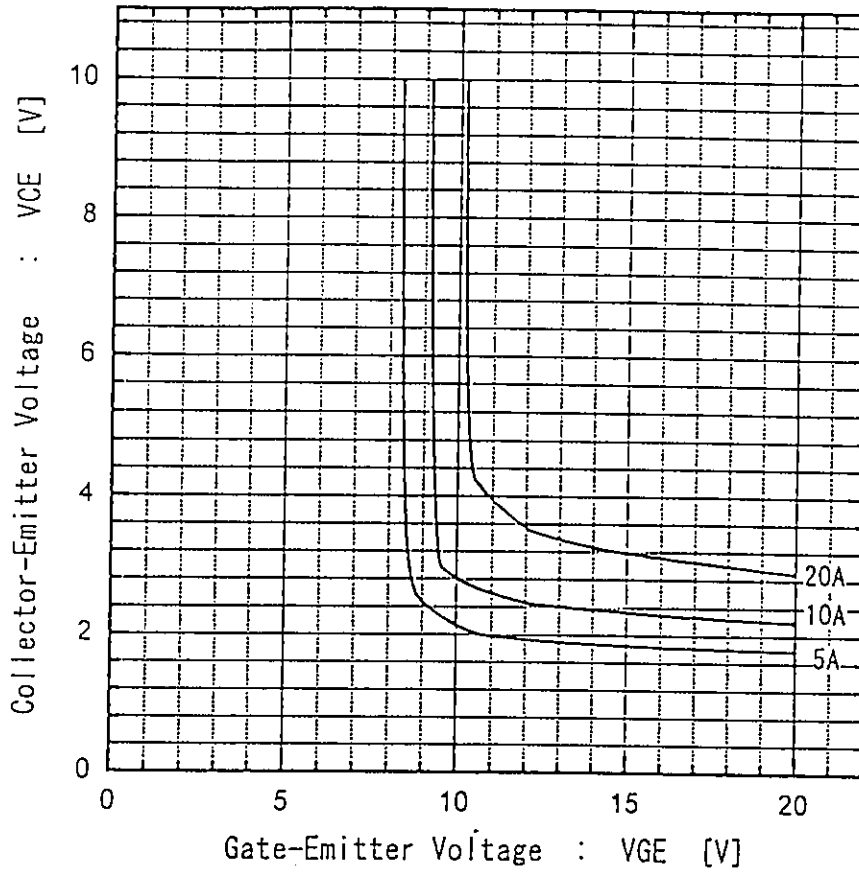

Collector-Emitter Voltage vs Gate-Emitter Voltage  
 $T_j=125^\circ\text{C}$

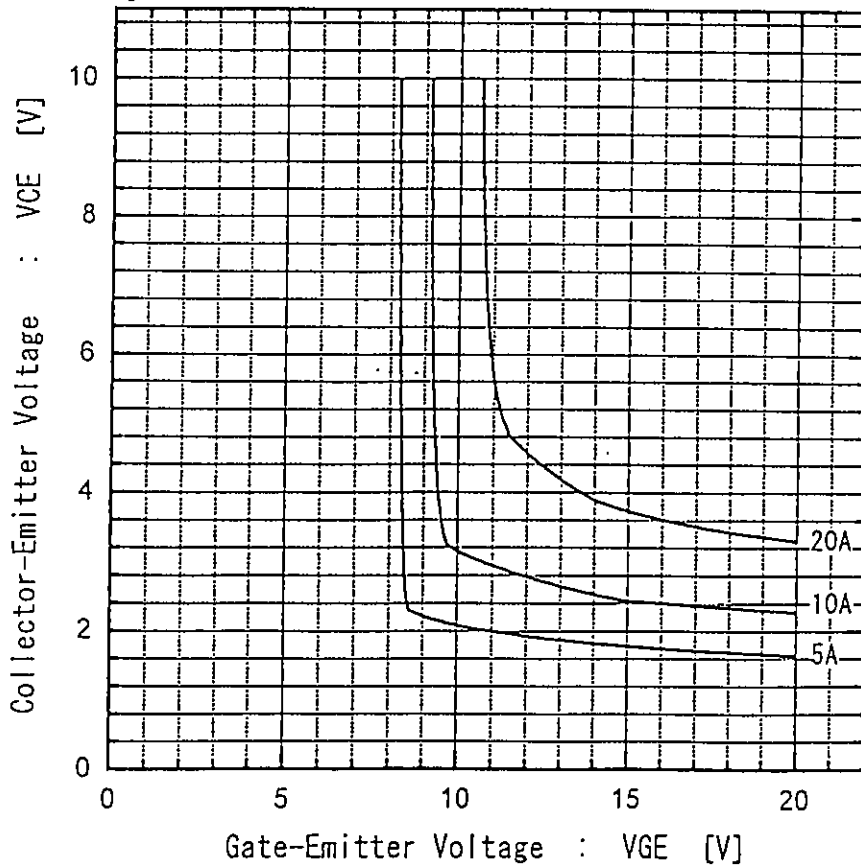

Fuji Electric Co., Ltd

DWG. NO.

5/12

H04-004-03

This material and the information herein is the property of Fuji Electric Co., Ltd. They shall be neither reproduced, copied, lent, or disclosed in any way whatsoever for the use of any third party nor used for the manufacturing purposes without the express written consent of Fuji Electric Co., Ltd.

Switching time vs. Collector current  
 $V_{cc}=300V, R_G=22\Omega, V_{GE}=\pm 15V, T_j=25^\circ C$

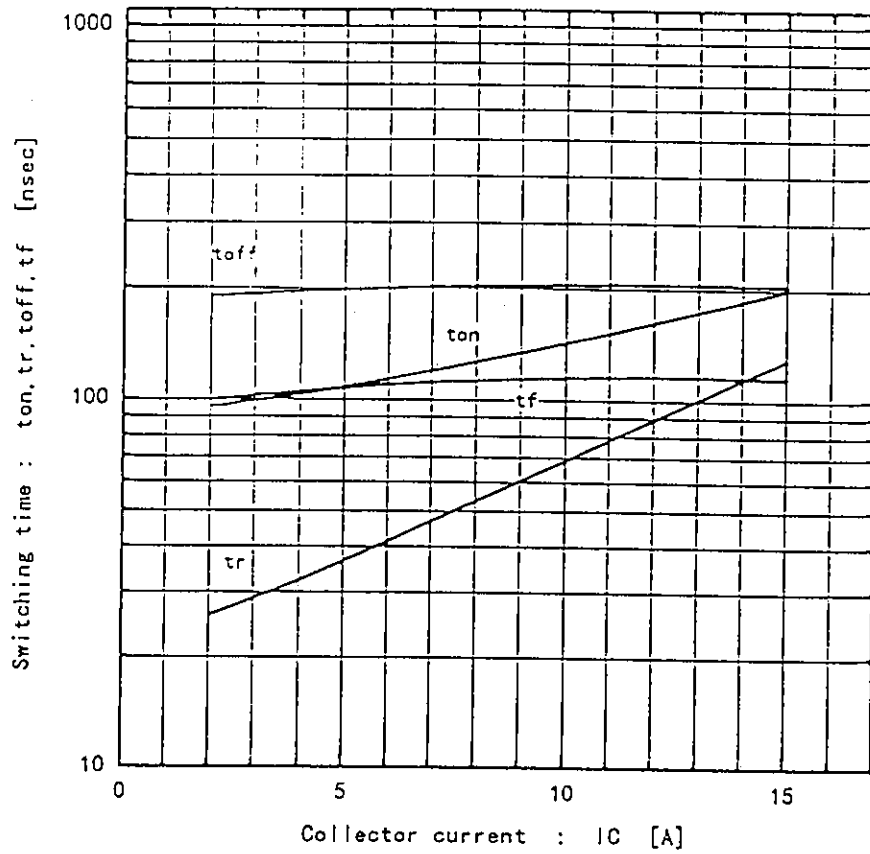

Switching time vs. Collector current  
 $V_{cc}=300V, R_G=22\Omega, V_{GE}=\pm 15V, T_j=125^\circ C$

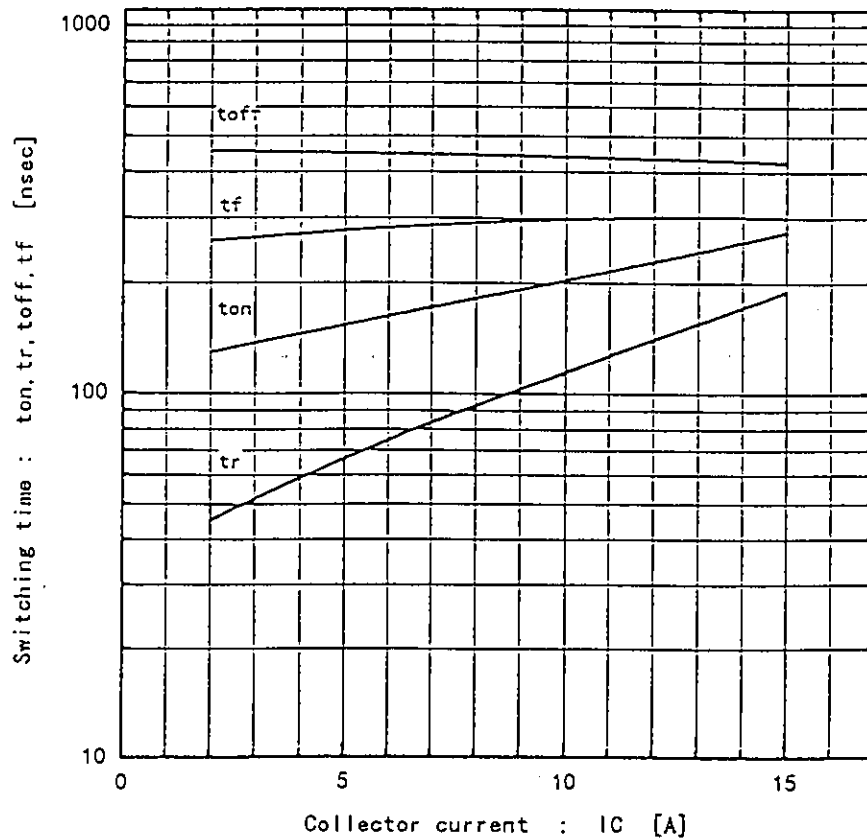

Fuji Electric Co., Ltd.

DWG. NO.

6/12

H04-004-03

This material and the information herein is the property of Fuji Electric Co., Ltd. They shall be neither reproduced, copied, lent, or disclosed in any way whatsoever for the use of any third party nor used for the manufacturing purposes without the express written consent of Fuji Electric Co., Ltd.

Switching time vs. RG  
 $V_{cc}=300V, I_C=10A, V_{GE}=\pm 15V, T_j=25^\circ C$

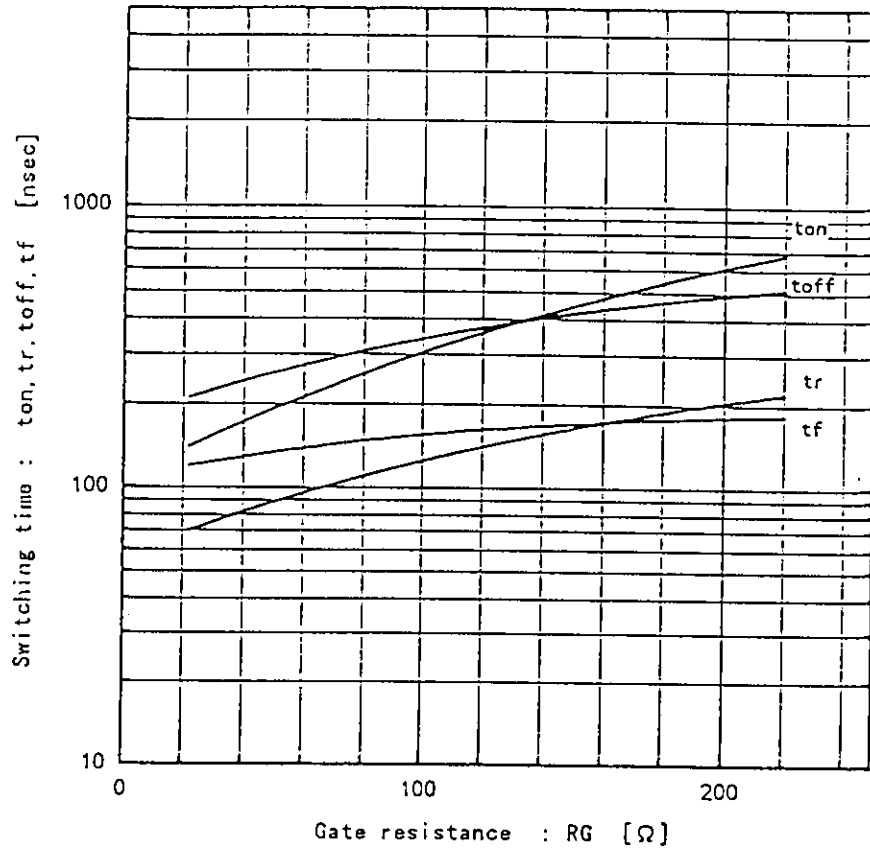

Switching time vs. RG  
 $V_{cc}=300V, I_C=10A, V_{GE}=\pm 15V, T_j=125^\circ C$

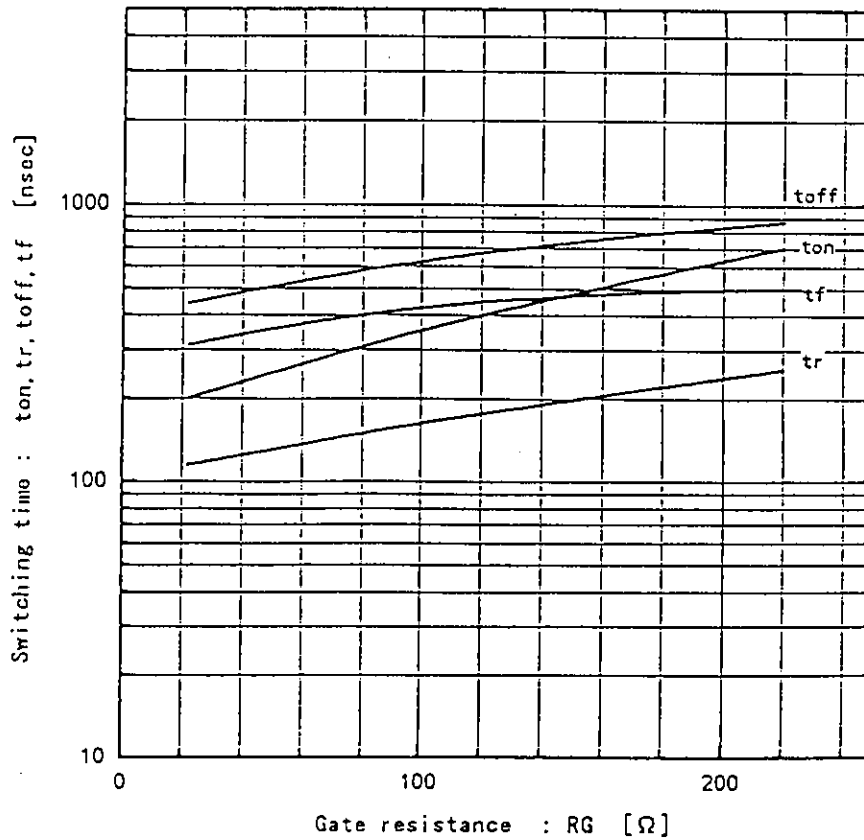

Fuji Electric Co., Ltd.

DWG. NO.

7/12

This material and the information herein is the property of Fuji Electric Co., Ltd. They shall be neither reproduced, copied, lent, or disclosed in any way whatsoever for the use of any third party nor used for the manufacturing purposes without the express written consent of Fuji Electric Co., Ltd.

Dynamic input characteristics  
 $T_j=25^\circ\text{C}$

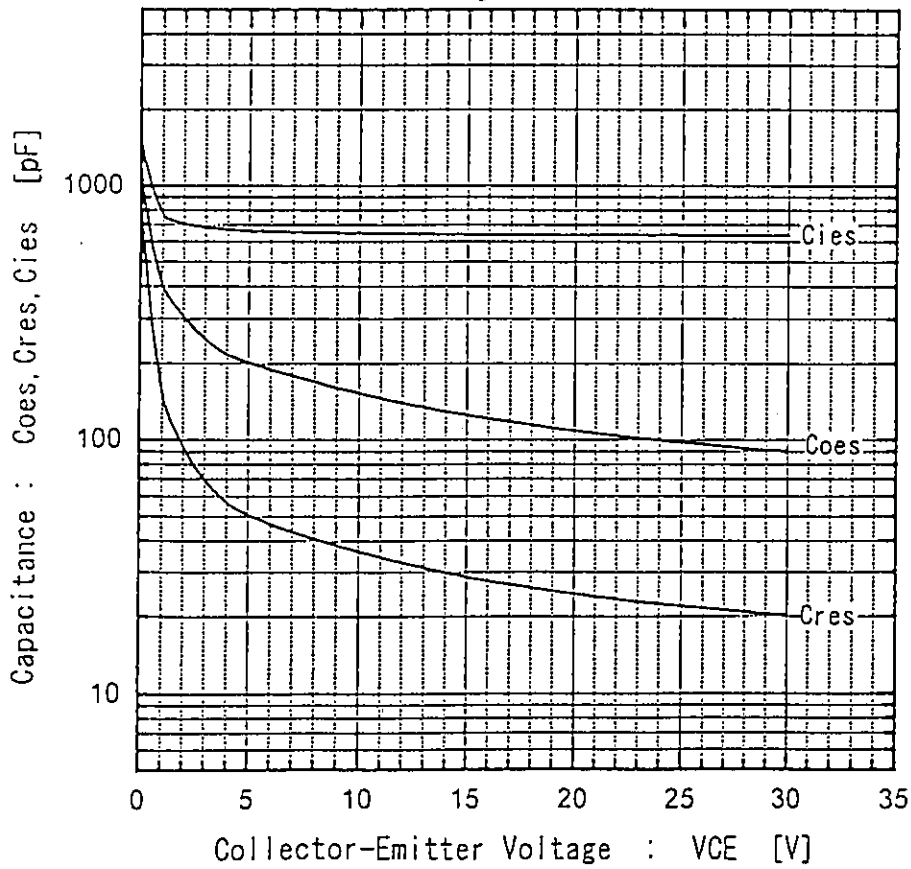
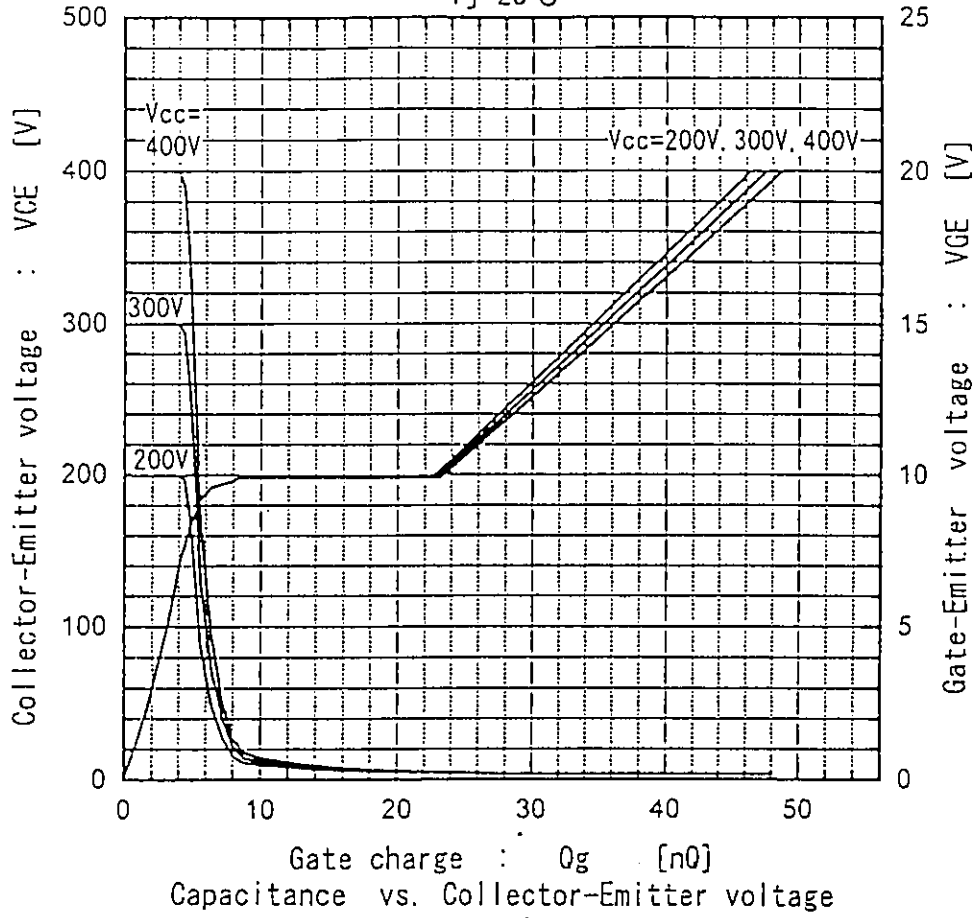

Fuji Electric Co., Ltd.

DWG. NO.

8/12

H04-004-03



Reverse Biased Safe Operating Area  
 $+V_{GE} = 15V$ ,  $-V_{GE} \leq 15V$ ,  $T_j \leq 125^\circ C$ ,  $R_G \geq 22\Omega$

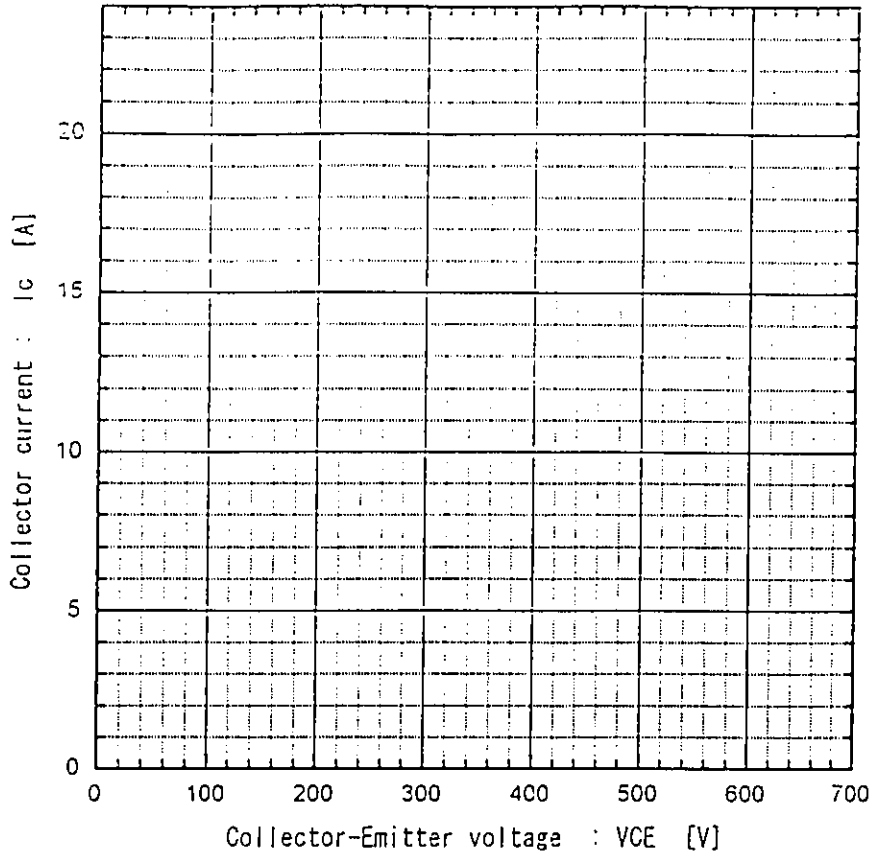

Typical short circuit capability  
 $V_{CC} = 400V$ ,  $R_G = 22\Omega$ ,  $T_j = 125^\circ C$

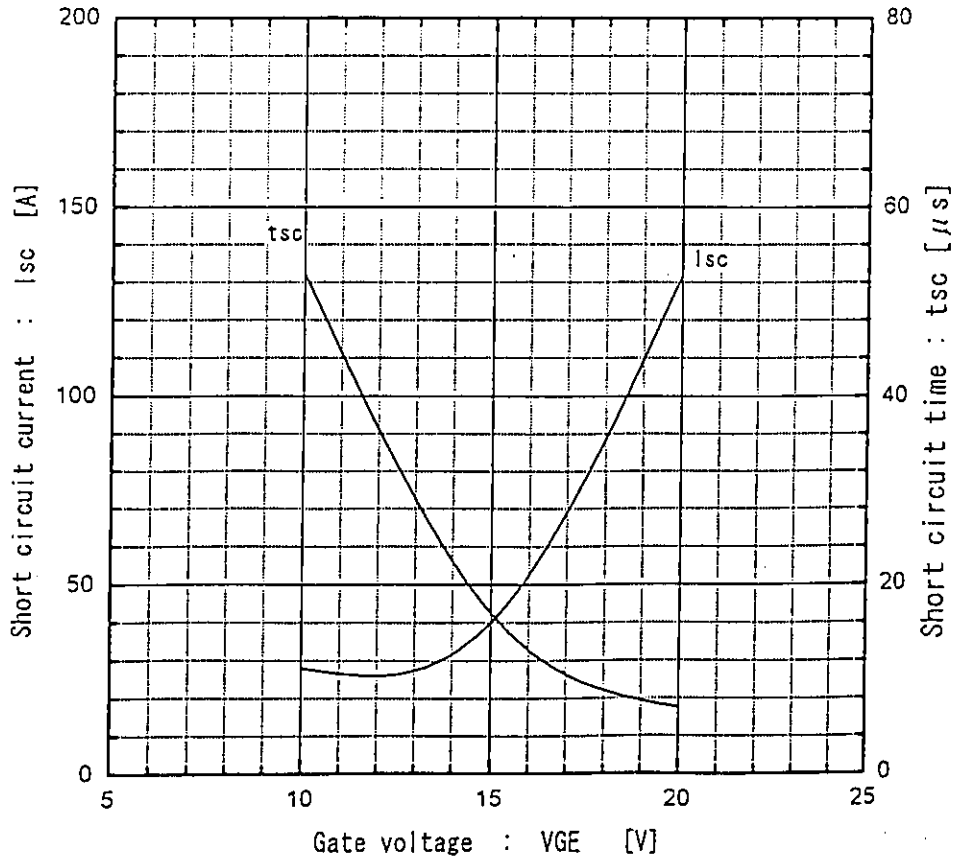

This material and the information herein is the property of Fuji Electric Co. Ltd. They shall be neither reproduced, copied, lent, or disclosed in any way whatsoever for the use of any third party nor used for the manufacturing purposes without the express written consent of Fuji Electric Co., Ltd.

Fuji Electric Co., Ltd.

DWG. NO.

9/12

1

H04-004-03

This material and the information herein is the property of Fuji Electric Co., Ltd. They shall be neither reproduced, copied, lent, or disclosed in any way whatsoever for the use of any third party nor used for the manufacturing purposes without the express written consent of Fuji Electric Co., Ltd.

Reverse recovery time vs. Forward current  
VR=200V, -di/dt=100A/ $\mu$ sec

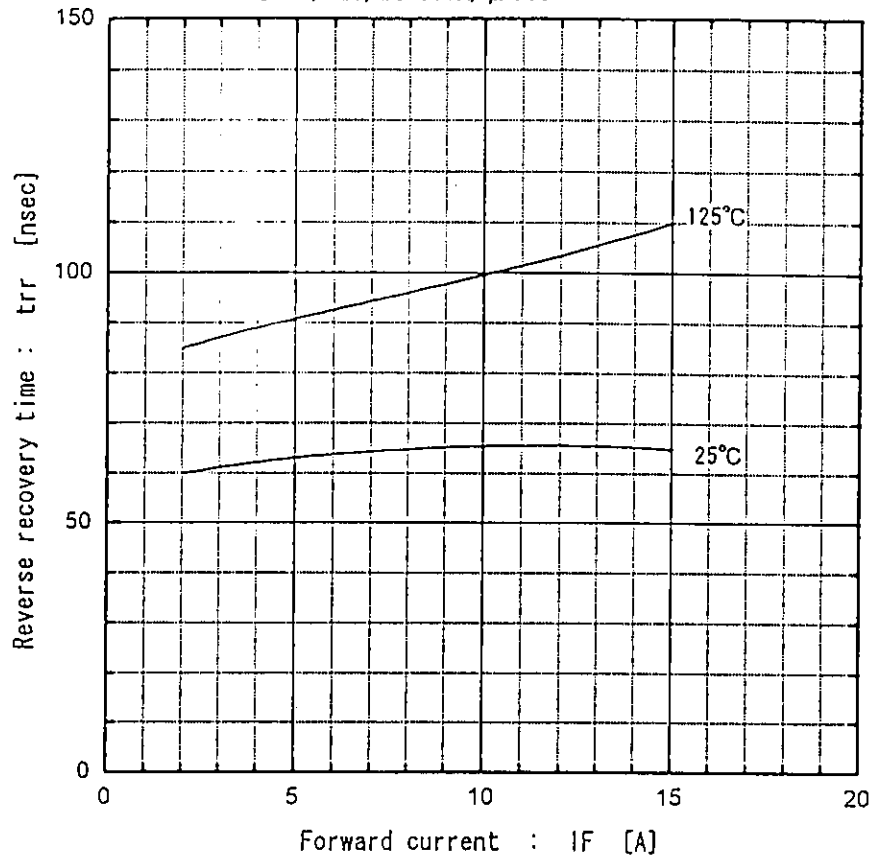

Reverse recovery current vs. Forward current  
VR=200V, -di/dt=100A/ $\mu$ sec

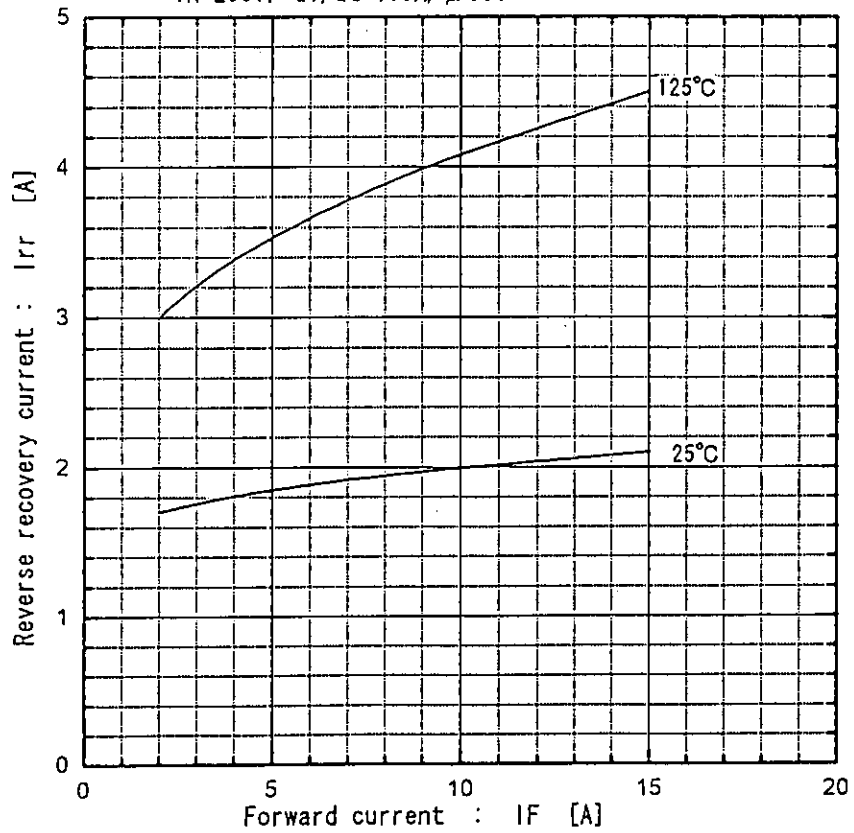

Fuji Electric Co., Ltd

DWG. NO.

10/12

H04-004-03

This material and the information herein is the property of Fuji Electric Co., Ltd. They shall be neither reproduced, copied, lent, or disclosed in any way whatsoever for the use of any third party nor used for the manufacturing purposes without the express written consent of Fuji Electric Co., Ltd.

Forward voltage vs. Forward current

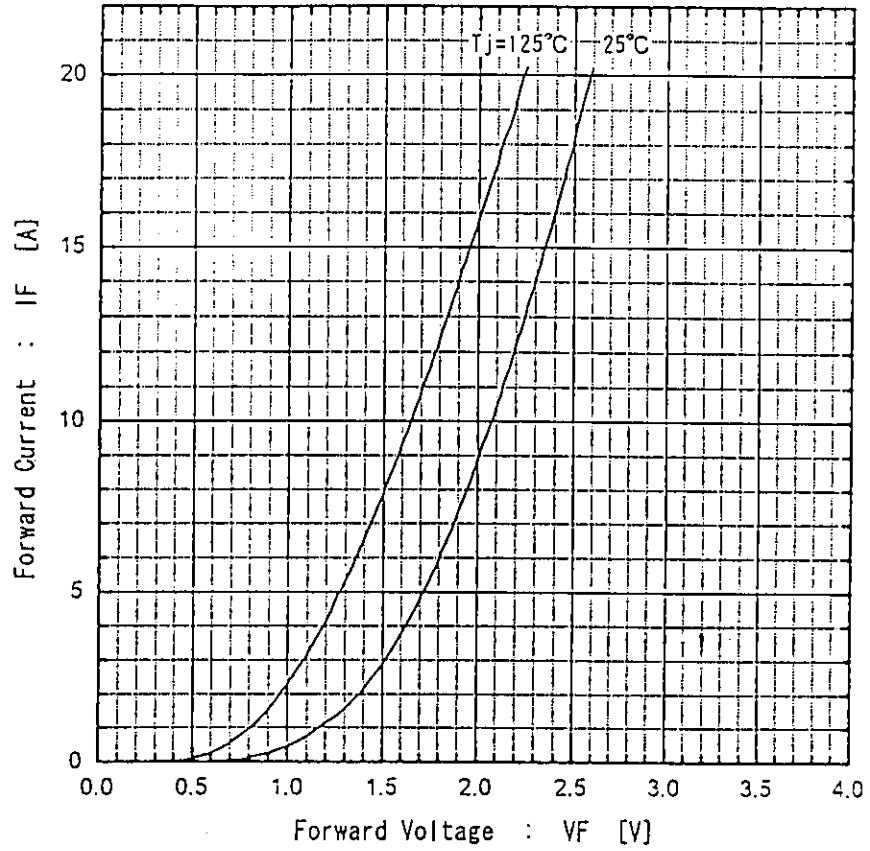

Reverse recovery characteristics vs.  $-di/dt$   
 $I_F=10A, T_j=125^\circ C$

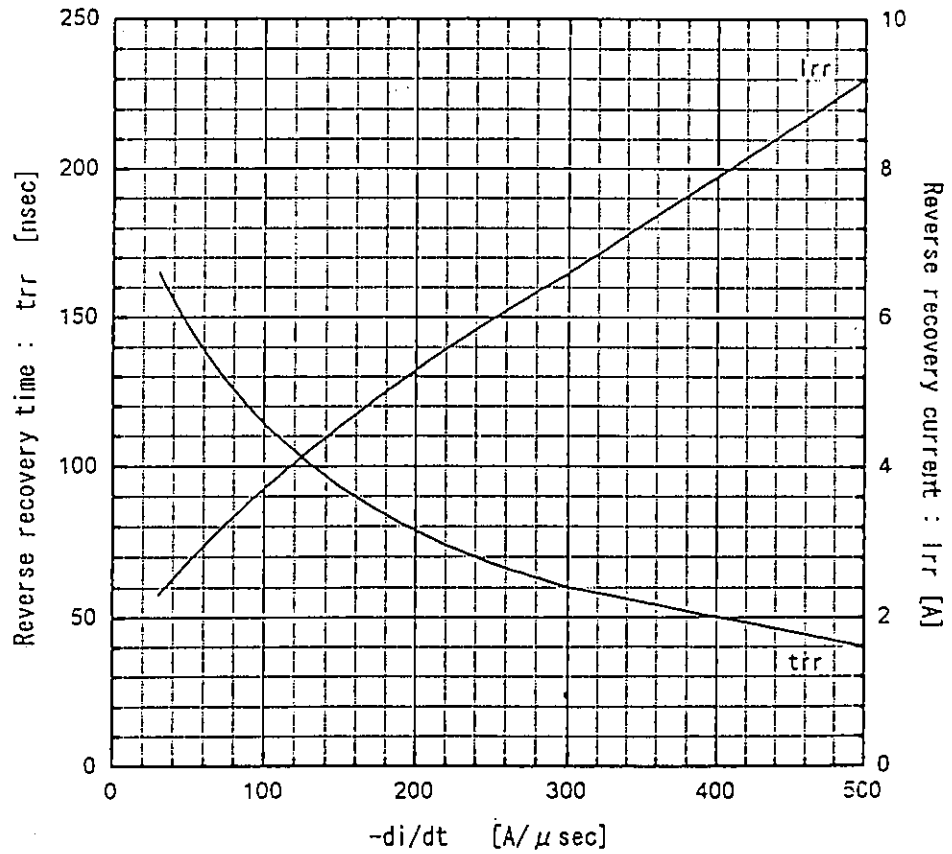

Fuji Electric Co., Ltd.

DWG. NO.

11/2

H04-004-03

# Transient thermal resistance

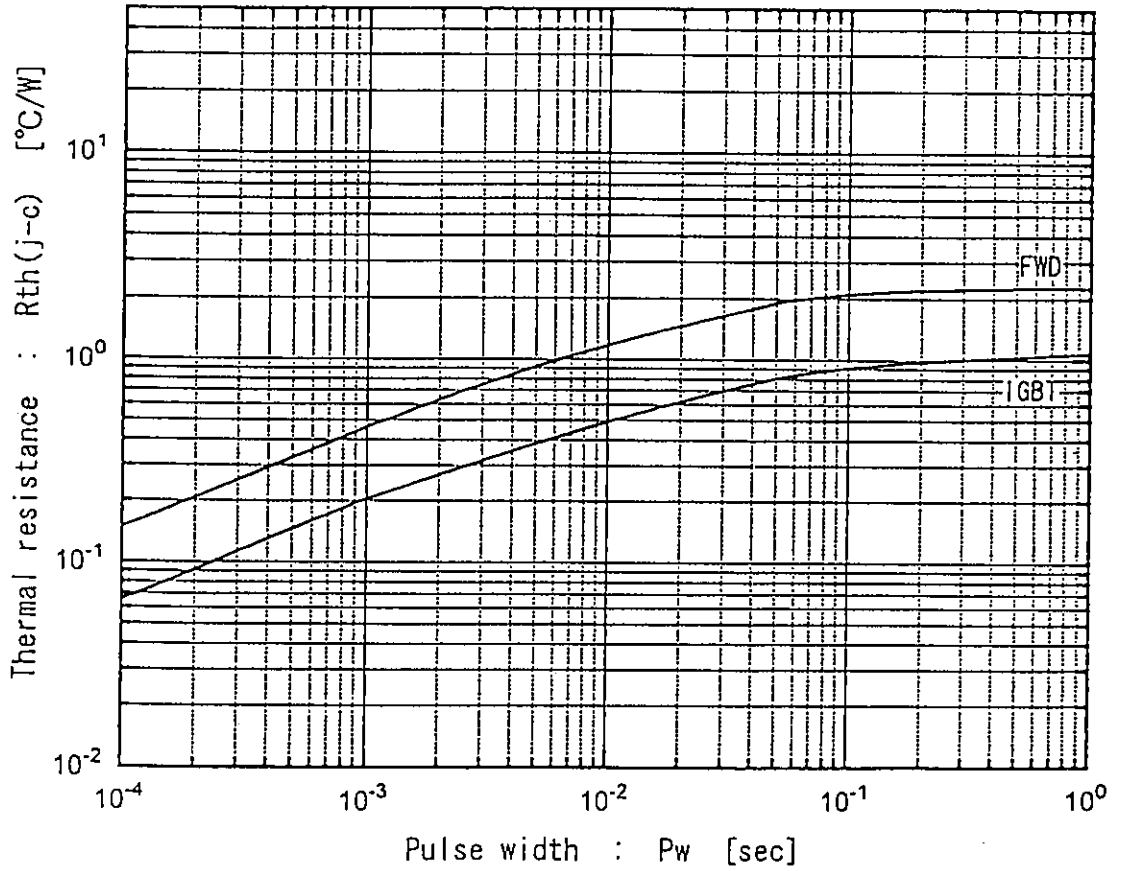

This material and the information herein is the property of Fuji Electric Co., Ltd. They shall be neither reproduced, copied, lent, or disclosed in any way whatsoever for the use of any third party nor used for the manufacturing purposes without the express written consent of Fuji Electric Co., Ltd.

Fuji Electric Co., Ltd.

DWG. NO.

12/12

H04-004-03