

Messrs. Rockwell Automation Co.,Ltd.

SPECIFICATION

Device Name : IGBT

Type Name : 1MBH05D-120-S06TT

Spec. No. : MS5F-4089

Date : June-11-1998

This material and the information herein is the property of Fuji Electric Co.,Ltd. They shall be neither reproduced, copied, lent, or disclosed in any way whatsoever for the use of any third party nor used for the manufacturing purposes without the express written consent of Fuji Electric Co.,Ltd.

Fuji Electric Co.,Ltd.
Matsumoto Factory

	DATE	NAME	APPROVED	Fuji Electric Co.,Ltd.	
DRAWN	June-11-98	R. Sawada		DWG. NO.	MS5F4089
CHECKED	June-11-98	T. Igarashi			

• Scope

This specification is applied to Fuji discrete IGBT 1MBH05D-120
supplied for Rockwell Automation Co.,Ltd.

• Construction

1. Package dimension
There is a package dimension in 4/14 page .
2. Outview
There are no remarkable flaws on a product .
3. Indication
 - ① Trademark
 - ② Type Name
 - ③ Lot No.

• Ratings and Characteristics

1. There are some ratings and characteristics tables in 4/14 page and 5/14 page .
2. There are some performance curves in from 6/14 page to 14/14 page .

• Packing

Packing style follows our packing specification ~~MS500026~~

MS5Q0030. (C)

This material and the information herein is the property of Fuji Electric Co., Ltd. They shall be neither reproduced, copied, lent, or disclosed in any way whatsoever for the use of any third party, nor used for the manufacturing purposes without the express written consent of Fuji Electric Co., Ltd.

Ratings and characteristics of Fuji IGBT

1MBH05D-120

1. Outline Drawing

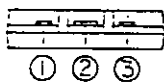
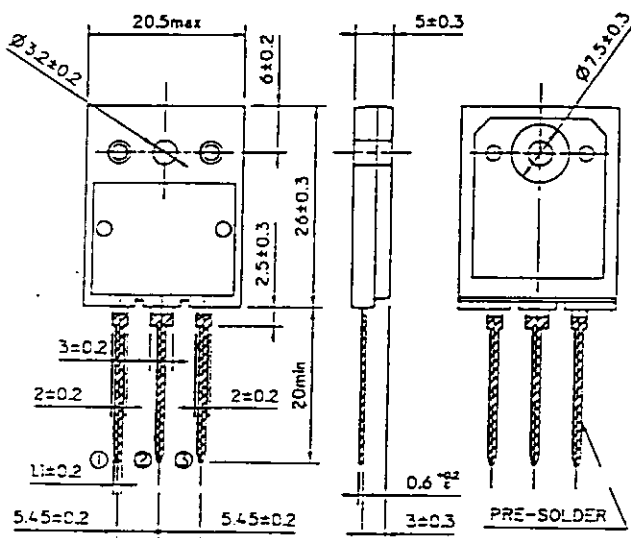

CONNECTION

- ① GATE
- ② COLLECTOR
- ③ EMITTER

2. Equivalent circuit

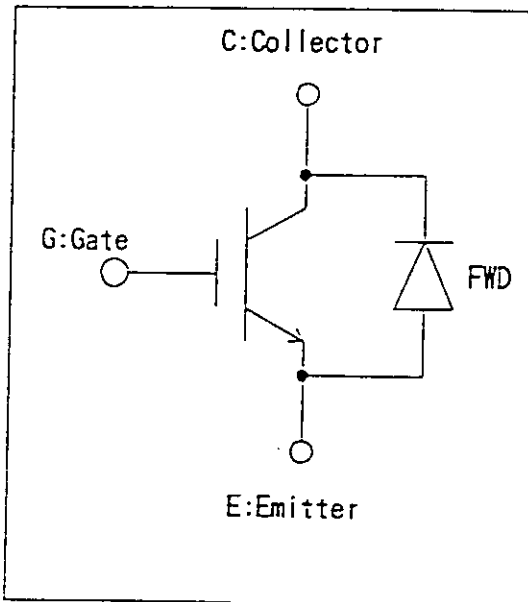

3. Absolute maximum ratings (Tc=25°C)

Items		Symbols	Ratings	Units	
Collector-Emitter Voltage		V_{CES}	1200	V	
Gate-Emitter Voltage		V_{GES}	± 22	V	
Collector Current	DC	Tc=25 °C	I_{C25}	10	A
		Tc=105°C	I_{C105}	5	A
	1ms	Tc=25 °C	I_{cp}	27	A
IGBT Max. Power Dissipation		P_c	115	W	
FWD Max. Power Dissipation		P_c	75	W	
Operating Temperature		T_j	+ 150	°C	
Storage Temperature		T_{stg}	-40 ~ +150	°C	
Mounting Screw Torque		—	70	N · cm	

4. Electrical Characteristics (at Tc=25°C unless otherwise specified)

Items	Symbols	Characteristics			Conditions	Unit	
		min.	typ.	max.			
Zero gate voltage Collector Current	I_{CES}			1.0	$V_{GE} = 0V$ $V_{CE} = 1200V$	mA	
Gate-Emitter leakage Current	I_{GES}			20	$V_{CE} = 0V$ $V_{GE} = \pm 22V$	μA	
Gate-Emitter Threshold Voltage	$V_{GE(th)}$	5.5		8.5	$V_{CE} = 20V$ $I_C = 5mA$	V	
Collector-Emitter Saturation Voltage	$V_{CE(sat)}$			3.5	$V_{GE} = 15V$ $I_C = 5A$	V	
Input capacitance	C_{ies}		650		$V_{GE} = 0V$	pF	
Output capacitance	C_{oes}		150		$V_{CE} = 10V$		
Reverse transfer capacitance	C_{res}		40		$f = 1MHz$		
Switching Time	Turn-on time	t_{on}		1.2	$V_{CC} = 600V$ $I_C = 5A$ $V_{GE} = \pm 15V$ $R_G = 330\Omega$ (Half Bridge)	μs	
		t_r		0.6			
	Turn-off time	t_{off}		1.5			
		t_f		0.5			
	Turn-on time	t_{on}		0.16	$V_{CC} = 600V$ $I_C = 5A$ $V_{GE} = +15V$ $R_G = 33\Omega$ (Half Bridge)		
		t_r		0.11			
	Turn-off time	t_{off}		0.30			
		t_f		0.50			
FWD forward voltage drop	V_F			3.0		$I_F = 5A$	V
Reverse recovery time	t_{rr}			0.35		$I_F = 5A, V_{GE} = -10V$ $V_R = 200V$ $di/dt = 100A/\mu s$	μs

5. Thermal resistance characteristics

Items	Symbols	Characteristics			Conditions	Unit
		min.	typ.	max.		
Thermal resistance	$R_{th(j-c)}$			1.08	IGBT	$^{\circ}C/W$
	$R_{th(j-c)}$			1.66	FWD	

Fuji Electric Co.,Ltd

DWG.NO.

MS5F4089

5/14

Collector Current vs. Collector-Emitter Voltage
 $T_j=25^\circ\text{C}$

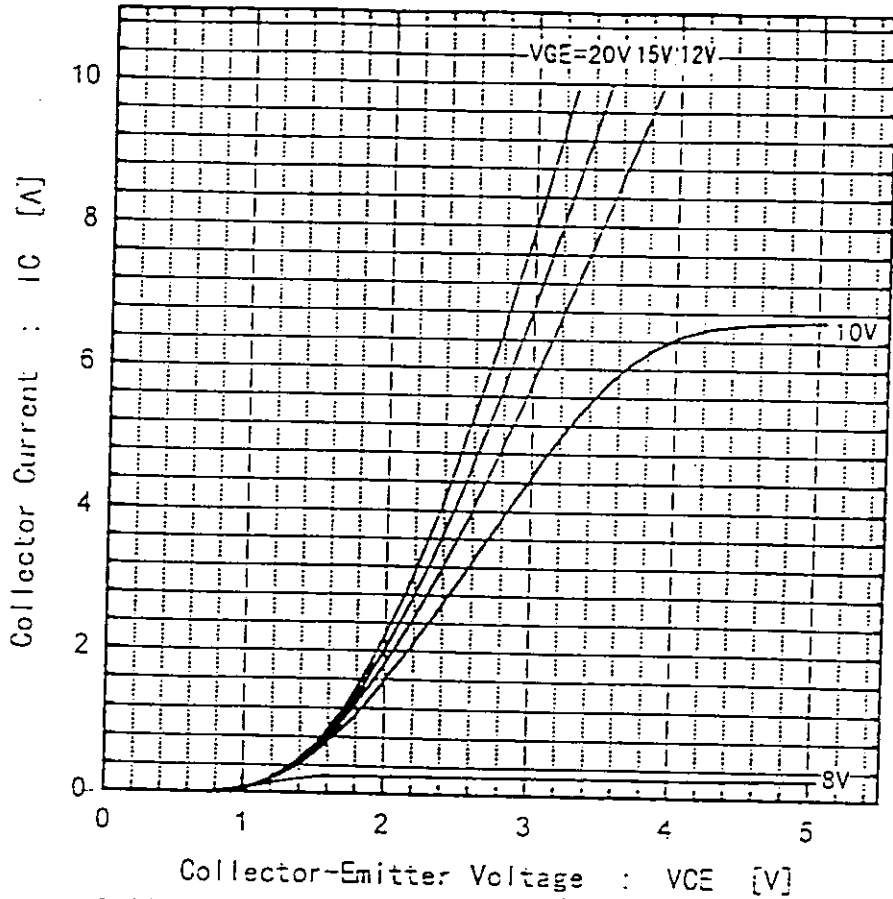

Collector Current vs. Collector-Emitter Voltage
 $T_j=125^\circ\text{C}$

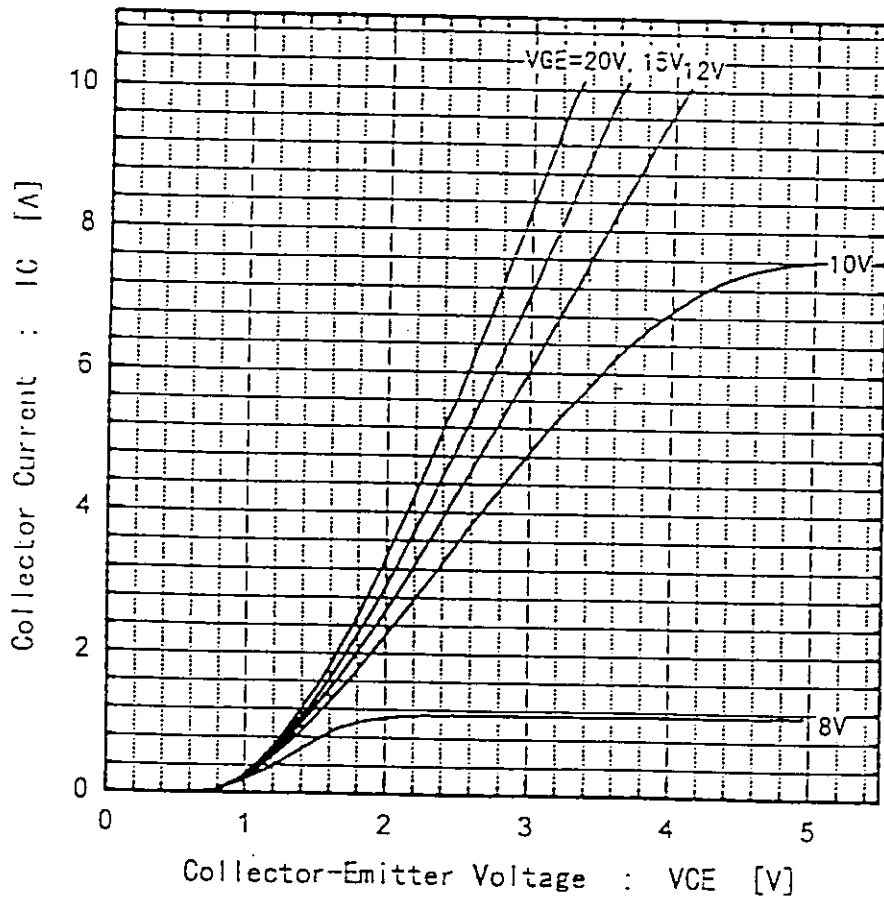

This material and the information herein is the property of Fuji Electric Co., Ltd. They shall be neither reproduced, copied, lent, or disclosed in any way whatsoever for the use of any third party nor used for the manufacturing purposes without the express written consent of Fuji Electric Co., Ltd.

Fuji Electric Co., Ltd.

DWG. NO.

MS5F4089

6/14

This material and the information herein is the property of Fuji Electric Co., Ltd. They shall be neither reproduced, copied, lent, or disclosed in any way whatsoever for the use of any third party nor used for the manufacturing purposes without the express written consent of Fuji Electric Co., Ltd.

Collector-Emitter Voltage vs Gate-Emitter Voltage
 $T_j=25^\circ\text{C}$

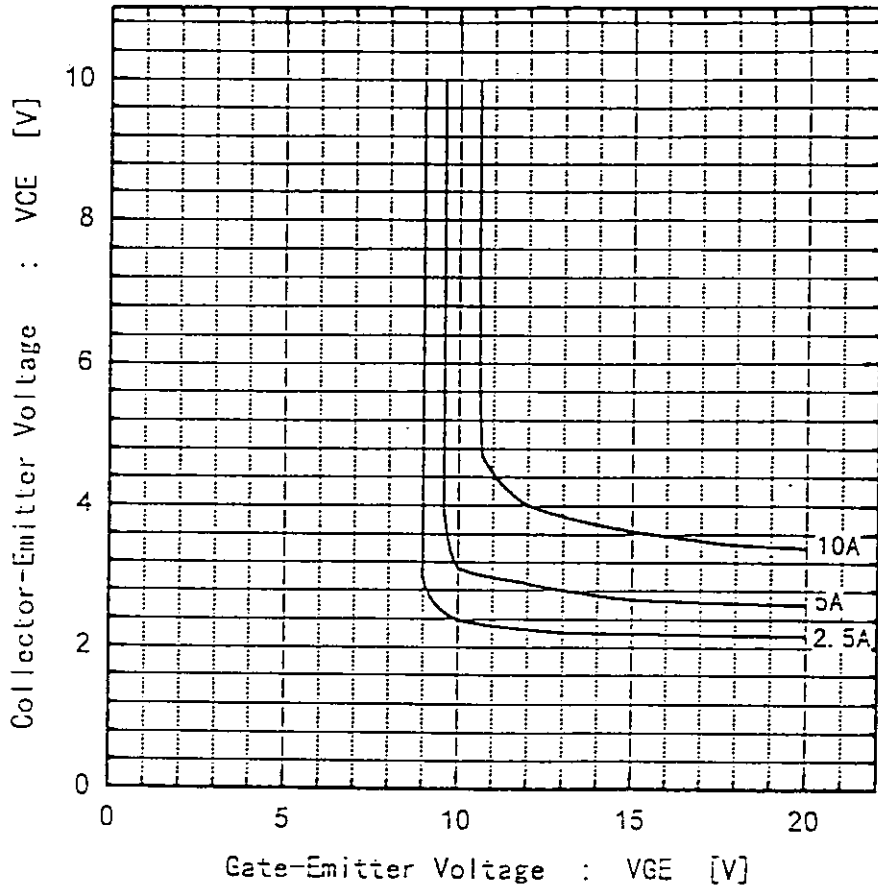

Collector-Emitter Voltage vs Gate-Emitter Voltage
 $T_j=125^\circ\text{C}$

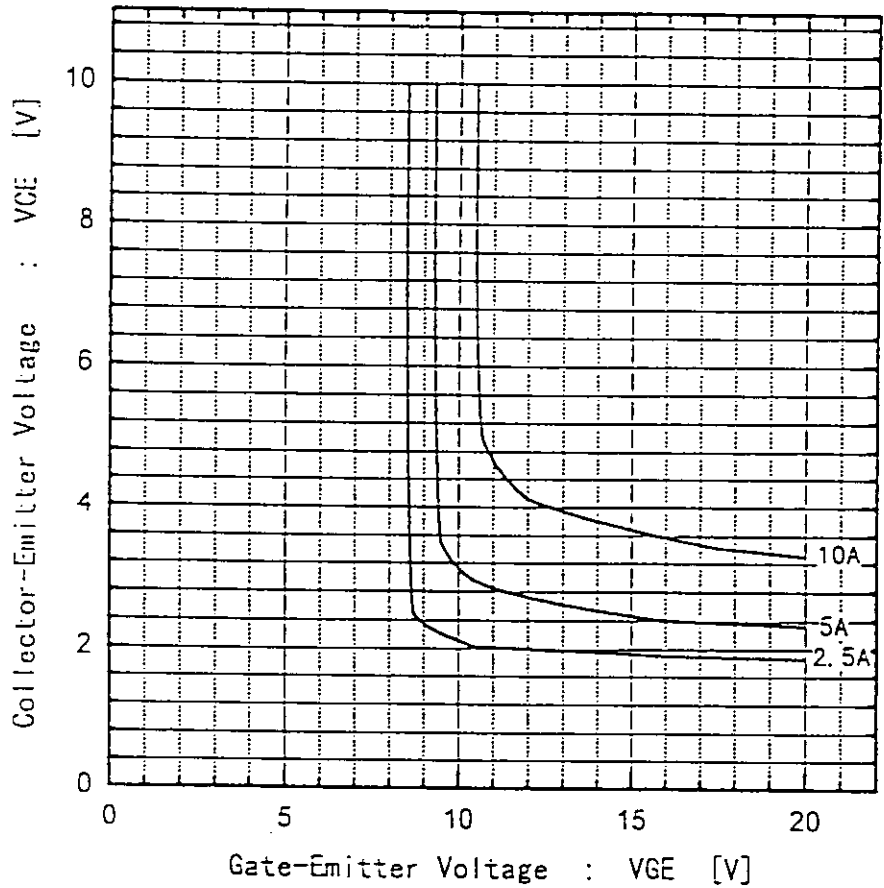

This material and the information herein is the property of Fuji Electric Co. Ltd. They shall be neither reproduced, copied, lent, or disclosed in any way whatsoever for the use of any third party nor used for the manufacturing purposes without the express written consent of Fuji Electric Co., Ltd.

Switching time vs. Collector current
 $V_{CC}=600V, R_G=33\Omega, V_{GE}=\pm 15V, T_j=25^\circ C$

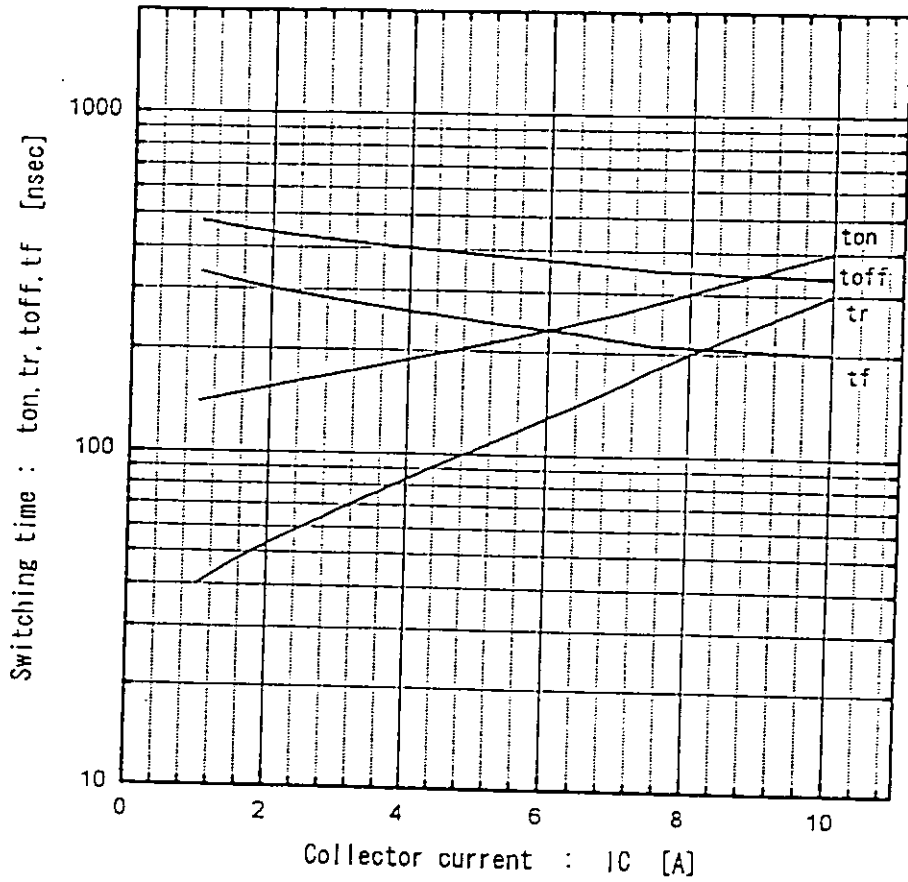

Switching time vs. Collector current
 $V_{CC}=600V, R_G=33\Omega, V_{GE}=\pm 15V, T_j=25^\circ C$

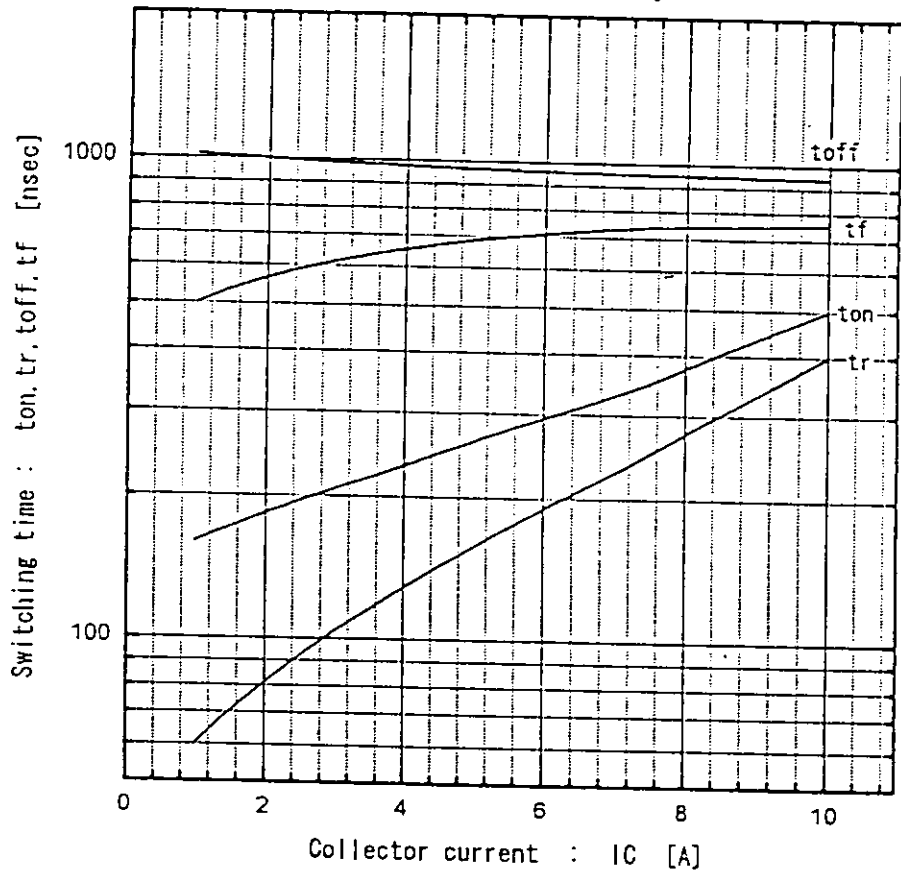

Fuji Electric Co., Ltd

DWG. NO.

MS5F4089

8/14

Switching time vs. RG
 $V_{CC}=600V, I_C=5A, V_{GE}=\pm 15V, T_j=25^\circ C$

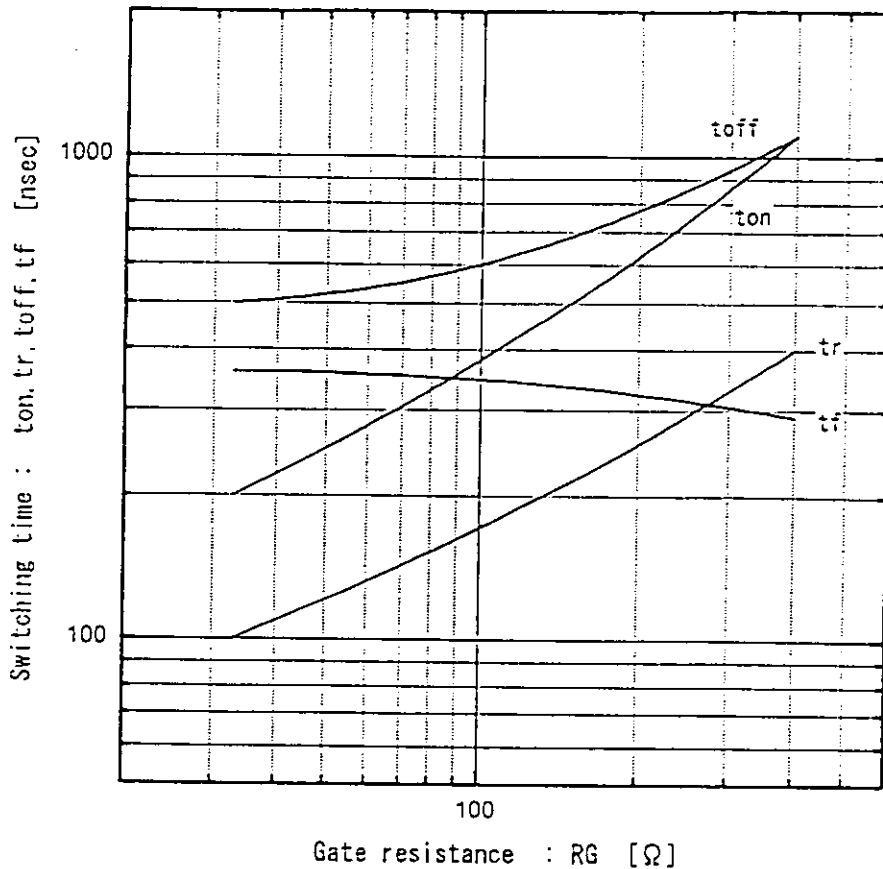

Switching time vs. RG
 $V_{CC}=500V, I_C=5A, V_{GE}=\pm 15V, T_j=125^\circ C$

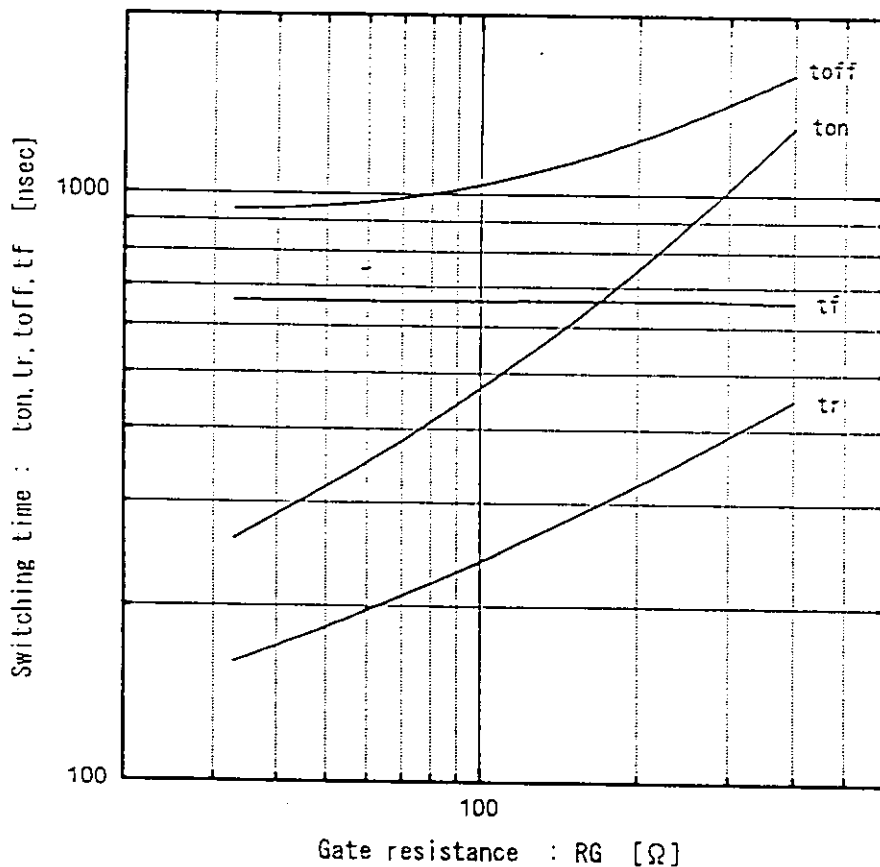

This material and the information herein is the property of Fuji Electric Co., Ltd. They shall be neither reproduced, copied, lent, or disclosed in any way whatsoever for the use of any third party nor used for the manufacturing purposes without the express written consent of Fuji Electric Co., Ltd.

This material and the information herein is the property of Fuji Electric Co., Ltd. They shall be neither reproduced, copied, lent, or disclosed in any way whatsoever for the use of any third party nor used for the manufacturing purposes without the express written consent of Fuji Electric Co., Ltd.

Dynamic input characteristics
Tj=25°C

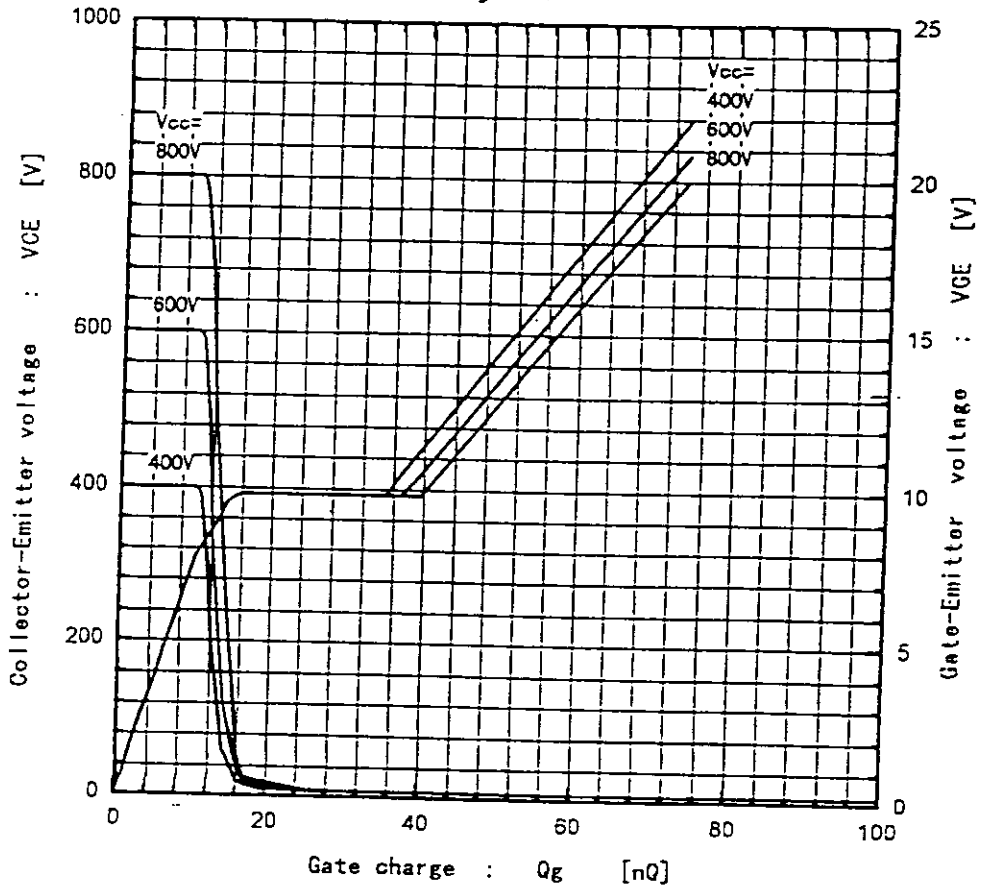

Capacitance vs. Collector-Emitter voltage
Tj=25°C

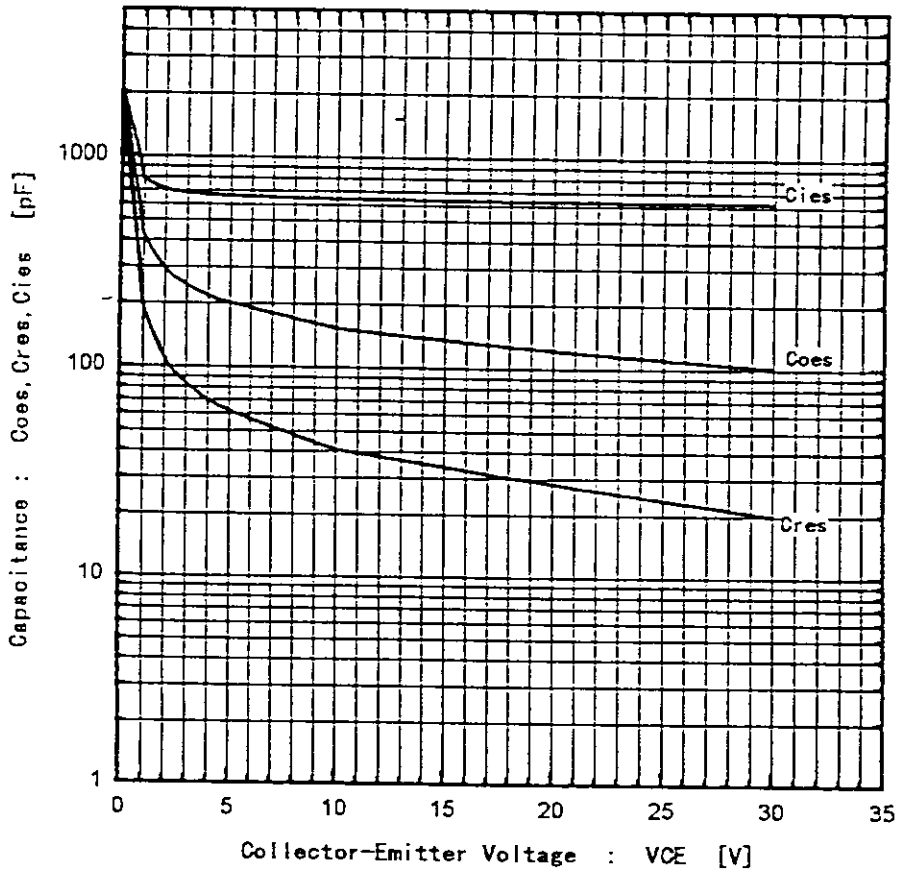

Fuji Electric Co., Ltd.

DWG. NO.

MS5F4089

10/14

Reverse Biased Safe Operating Area
 $+V_{GE} = 15V, -V_{GE} \leq 15V, T_j \leq 125^\circ C, R_G \geq 33\Omega$

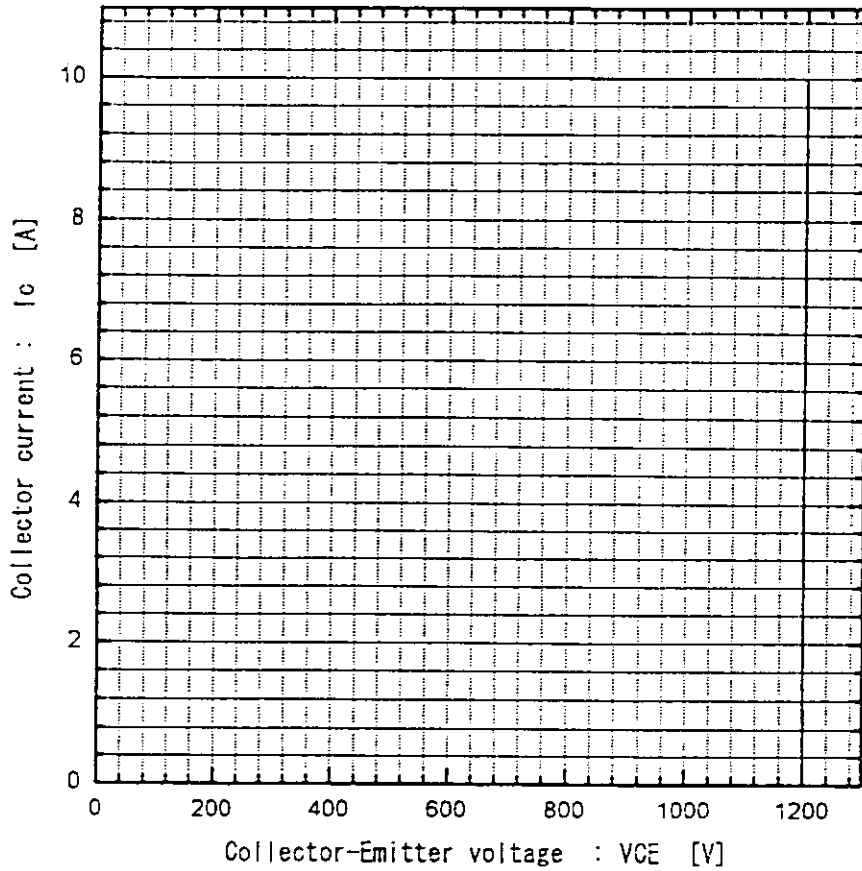

Typical short circuit capability
 $V_{CC} = 800V, R_G = 33\Omega, T_j = 125^\circ C$

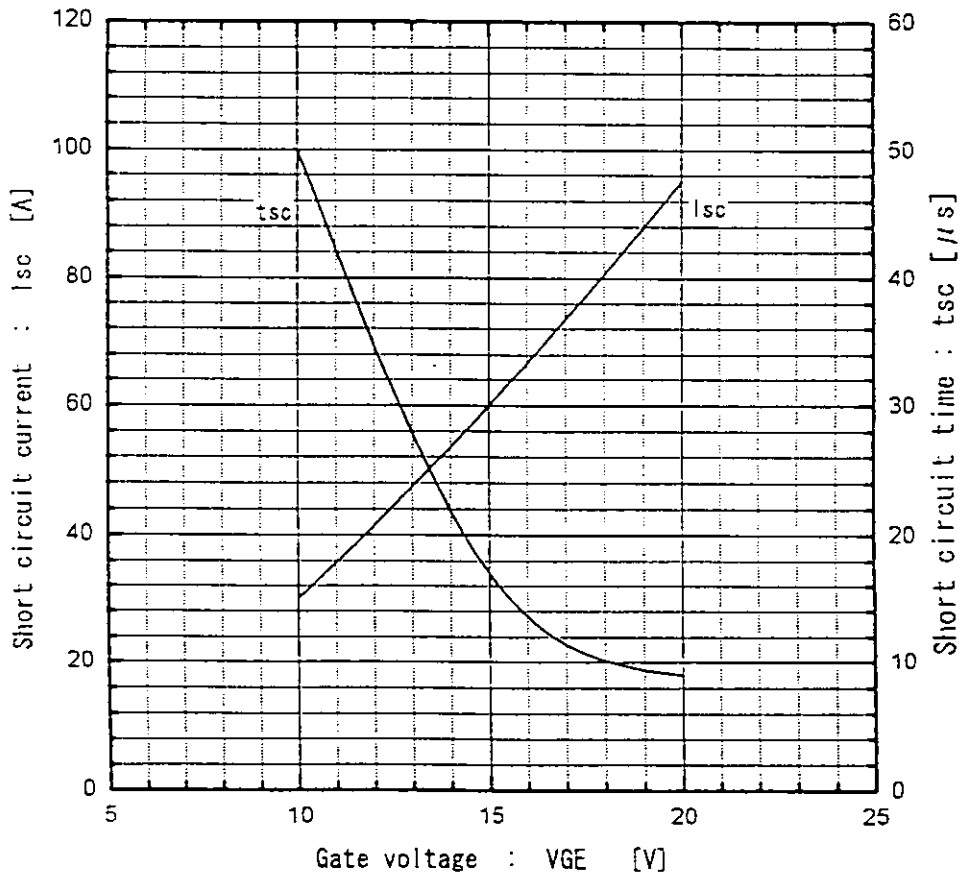

This material and the information herein is the property of Fuji Electric Co. Ltd. They shall be neither reproduced, copied, lent, or disclosed in any way whatsoever for the use of any third party nor used for the manufacturing purposes without the express written consent of Fuji Electric Co., Ltd.

Fuji Electric Co., Ltd.

DWG. NO.

MS5F4089

11/14

H04-004-03

This material and the information herein is the property of Fuji Electric Co., Ltd. They shall be neither reproduced, copied, loaned, or disclosed in any way whatsoever for the use of any third party nor used for the manufacturing purposes without the express written consent of Fuji Electric Co., Ltd.

Reverse recovery time vs. Forward current
 $VR=200V, -di/dt=100A/\mu sec$

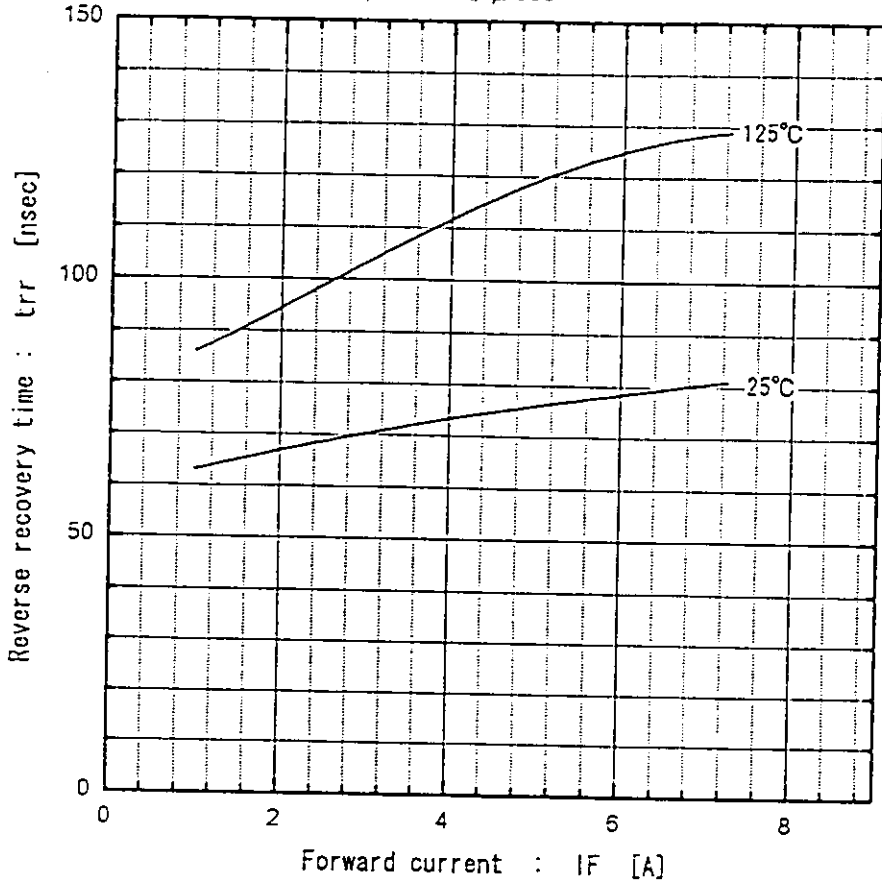

Reverse recovery current vs. Forward current
 $VR=200V, -di/dt=100A/\mu sec$

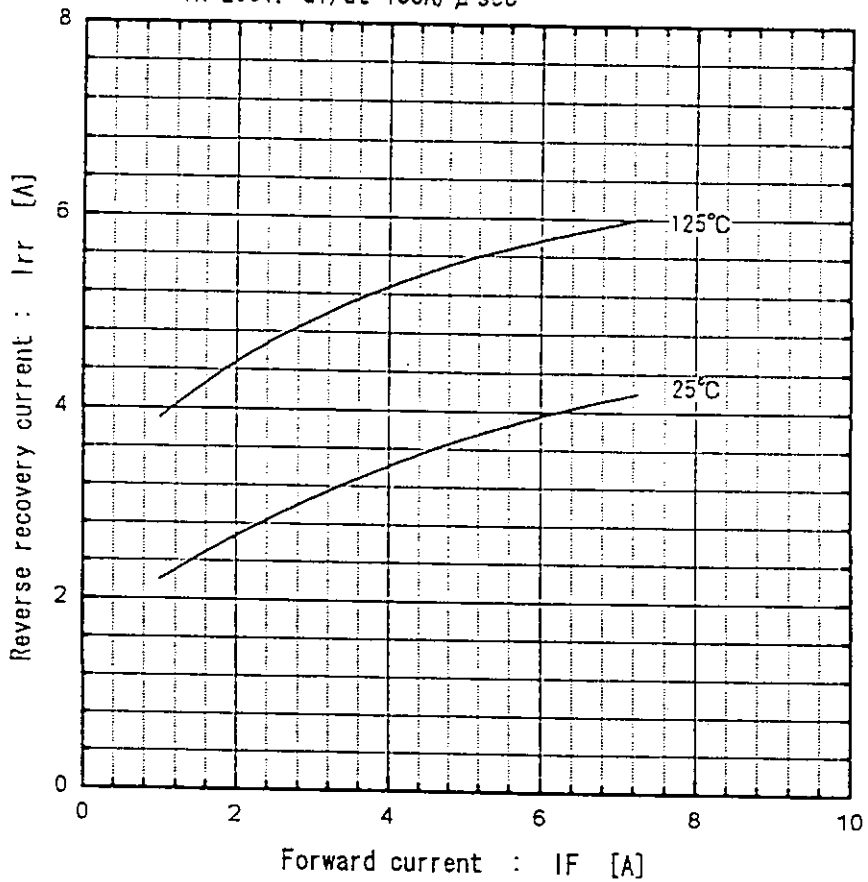

Fuji Electric Co., Ltd.

DWG. NO.

MS5 F 4089

12/19

Forward voltage vs. Forward current

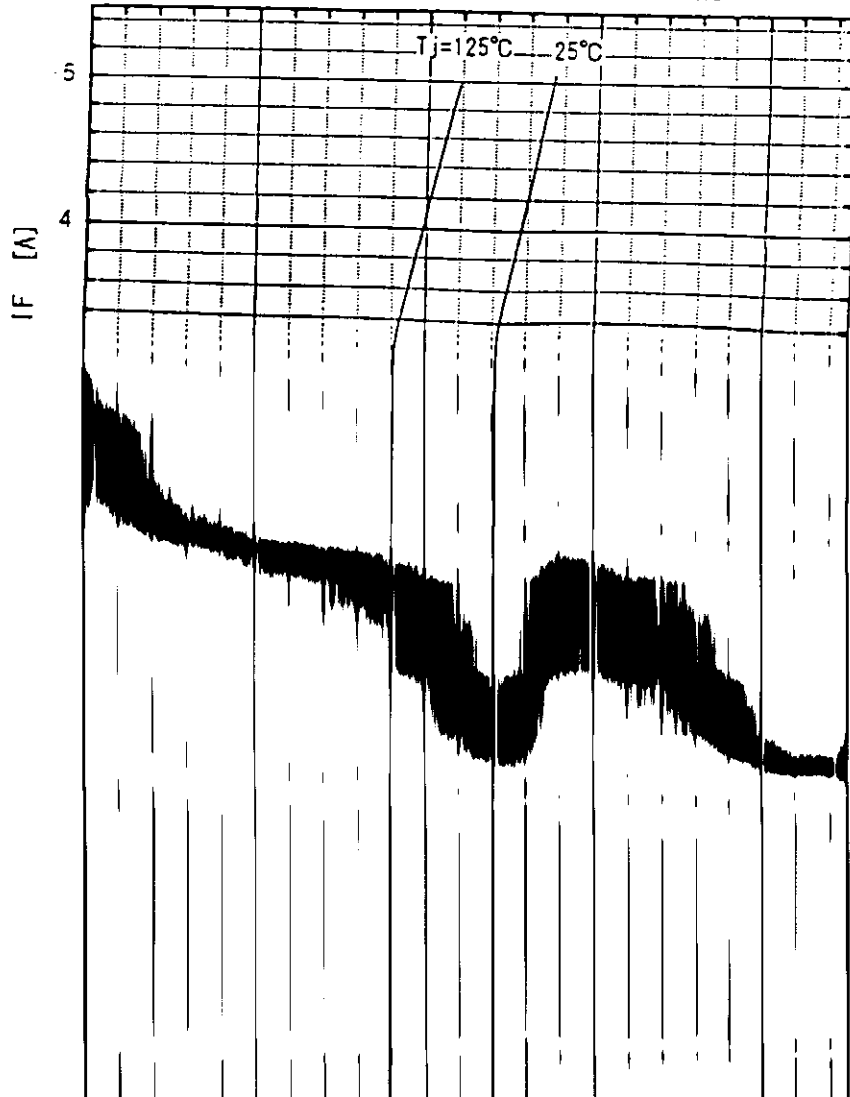

Forward voltage vs. Forward current

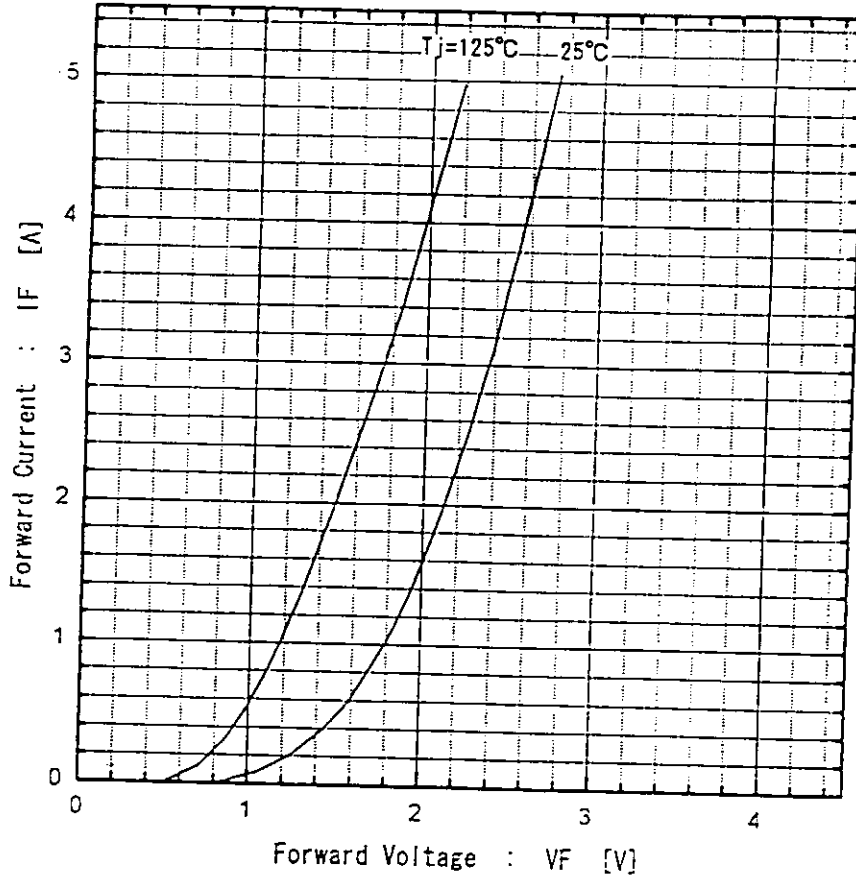

Reverse recovery characteristics vs. $-di/dt$
IF=5A, Tj=125°C

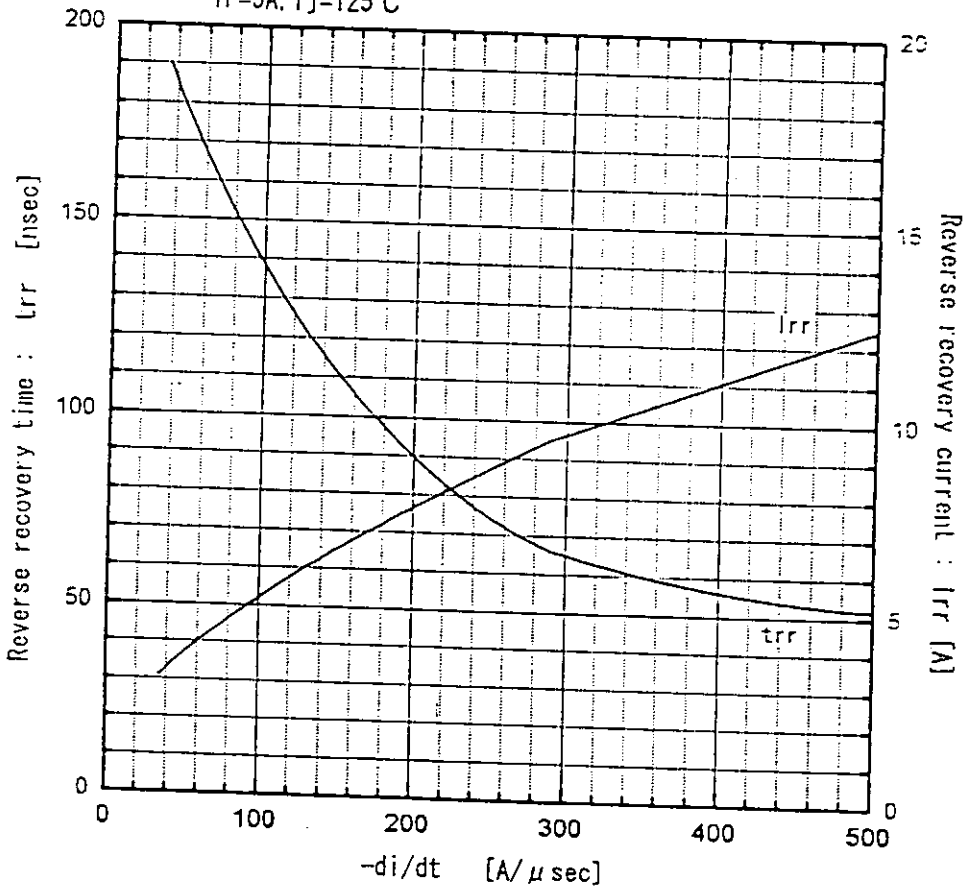

This material and the information herein is the property of Fuji Electric Co. Ltd. They shall be neither reproduced, copied, lent, or disclosed in any way whatsoever for the use of any third party nor used for the manufacturing purposes without the express written consent of Fuji Electric Co., Ltd.

Fuji Electric Co., Ltd.

DWG. NO.

MS5 F 4089

13/14

Transient thermal resistance

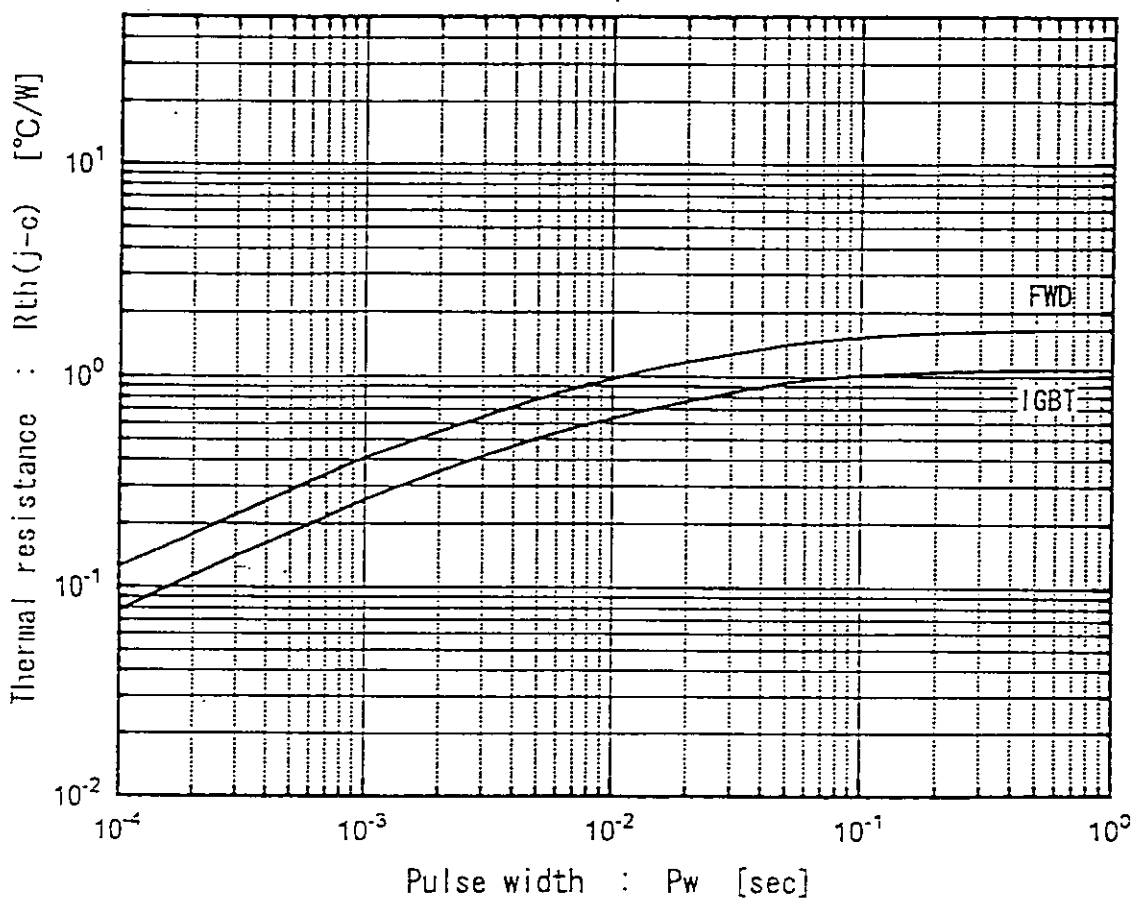

This material and the information herein is the property of Fuji Electric Co. Ltd. They shall be neither reproduced, copied, lent, or disclosed in any way whatsoever for the use of any third party nor used for the manufacturing purposes without the express written consent of Fuji Electric Co., Ltd.

Fuji Semiconductor, Inc. - P.O. Box 702708 - Dallas, TX 75370 - 972-733-1700 -
www.fujisemiconductor.com

Fuji Electric Co., Ltd.

DWG. NO.

MS5 F 4089

14/17

H04-004-03