

■ Block diagram

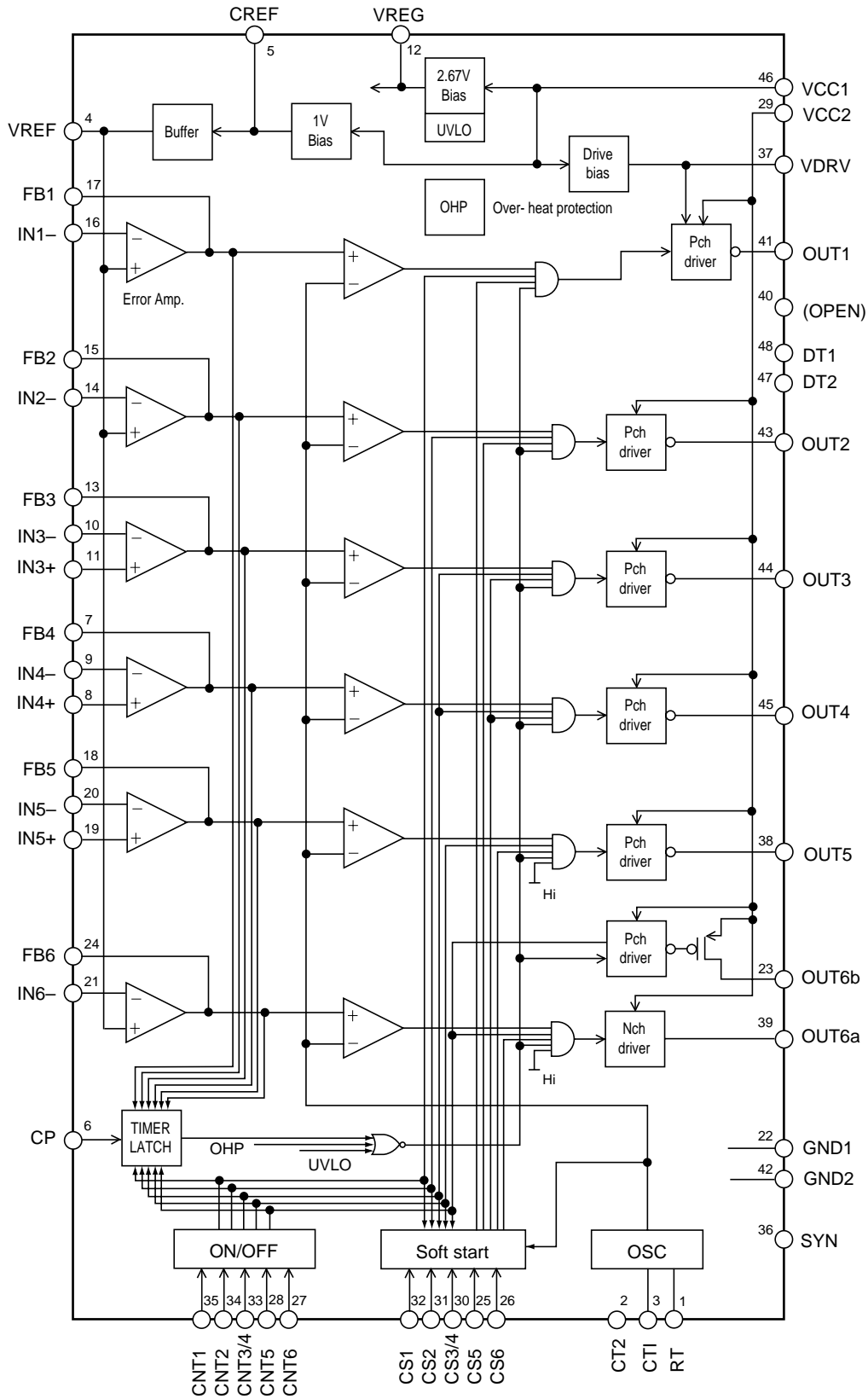

Pin No.	Pin symbol	Description
1	RT	Oscillator timing resistor
2	CT2	(Not connect any component)
3	CT1	Oscillator timing capacitor
4	VREF	Reference voltage output
5	CREF	Capacitor for reference voltage output
6	CP	Timing capacitor for timer latch delay
7	FB4	Ch. 4 output of error amplifier
8	IN4+	Ch. 4 non-inverting input to error amplifier
9	IN4-	Ch. 4 inverting input to error amplifier
10	IN3-	Ch. 3 inverting input to error amplifier
11	IN3+	Ch. 3 non-inverting input to error amplifier
12	VREG	Regulated voltage output
13	FB3	Ch. 3 output of error amplifier
14	IN2-	Ch. 2 inverting input to error amplifier
15	FB2	Ch. 2 output of error amplifier
16	IN1-	Ch. 1 inverting input to error amplifier
17	FB1	Ch. 1 output of error amplifier
18	FB5	Ch. 5 output of error amplifier
19	IN5+	Ch. 5 non-inverting input to error amplifier
20	IN5-	Ch. 5 inverting input to error amplifier
21	IN6-	Ch. 6 inverting input to error amplifier
22	GND1	Ground
23	OUT6b	ON/OFF switch for ch.6 power supply
24	FB6	Ch. 6 output of error amplifier

Pin No.	Pin symbol	Description
25	CS5	Soft start for Ch. 5
26	CS6	Soft start for Ch. 6
27	CNT6	Ch. 6 ON/OFF function
28	CNT5	Ch. 5 ON/OFF function
29	VCC2	Power supply for output stage
30	CS3/4	Soft start for Ch. 3 & Ch. 4
31	CS2	Soft start for Ch. 2
32	CS1	Soft start for Ch. 1
33	CNT3/4	Ch. 3 & Ch. 4 ON/OFF function
34	CNT2	Ch. 2 ON/OFF function
35	CNT1	Ch. 1 ON/OFF function
36	SYN	(Connect to GND1/ GND2 terminal)
37	VDRV	Bias for logic circuit of outputs
38	OUT5	Ch. 5 output (for Pch-MOSFET)
39	OUT6a	Ch. 6 output (for Nch-MOSFET)
40	(OPEN)	(Not connect any component)
41	OUT1	Ch. 1 output (for Pch-MOSFET)
42	GND2	Ground
43	OUT2	Ch. 2 output (for Pch-MOSFET)
44	OUT3	Ch. 3 output (for Pch-MOSFET)
45	OUT4	Ch. 4 output (for Pch-MOSFET)
46	VCC1	Power supply for control circuit
47	DT2	(Connect to DT1)
48	DT1	(Connect to DT2)

■ Absolute maximum ratings

Item	Symbol	Rating	Unit
Power supply voltage	V _{CC}	20.0	V
Source peak current	I _{OUT}	-200	mA
Sink peak current	I _{OUT}	200	mA
Output peak current of OUT6b	I _{OUT6b}	-500	mA
Input voltage for analog input	V _{ANA}	-0.3 to +2.8	V
Input voltage for logic input	V _{LOG}	-0.3 to +5.5	V
Total power dissipation *	P _d	550	mW
Junction temperature	T _J	125	°C
Ambient temperature	T _{OP}	-20 to +85	°C
Storage temperature	T _{stg}	-40 to +125	°C

* T_a < 25°C

■ Recommended operating conditions

Item	Symbol	Min.	Max.	Unit
Power supply voltage	V _{CC}	4.5	18.0	V
Input voltage for logic input	V _{LOG}	0.0	5.25	V
Oscillation frequency	f _{OSC}	50	1000	kHz
Oscillator timing resistor	R _T	6.8	100	kΩ
Oscillator timing capacitor	C _T	68	1000	pF
CREF terminal by-pass capacitor	C _{REF}	0.01		μF
VREF terminal output current	I _{REF}	-60	0	μA

■ Electrical characteristics ($T_a=25^\circ\text{C}$, $V_{CC1}=V_{CC2}=6\text{V}$, $C_T=100\text{pF}$, $R_T=18\text{k}\Omega$)

Reference voltage section

Item	Symbol	Test condition	Min.	Typ.	Max.	Unit
Output voltage	V_{REF}		0.985	1.00	1.015	V
Line regulation	V_{RLIN}	$V_{CC}=4.5$ to 18V		3	10	mV
Output voltage variation due to temperature change	V_{RTa}	$T_a=-20$ to $+85^\circ\text{C}$		± 0.5		%

Regulated voltage section

Item	Symbol	Test condition	Min.	Typ.	Max.	Unit
Output voltage	V_{REG}		2.40	2.67	2.95	V

Oscillator section

Item	Symbol	Test condition	Min.	Typ.	Max.	Unit
Oscillation frequency	f_{OSC}	$R_T=18\text{k}\Omega$, $C_T=100\text{pF}$	414	460	506	kHz
Frequency variation due to supply voltage change	f_{dV}	$V_{CC}=4.5$ to 18V		± 1	± 3	%
Frequency variation due to temperature change	f_{dT}	$T_a=-20$ to $+25^\circ\text{C}$ $T_a=+25$ to $+85^\circ\text{C}$		± 1.5 ± 1.5		%

Error amplifier section

Item	Symbol	Test condition	Min.	Typ.	Max.	Unit
Input offset voltage	V_{IOF}				10	mV
Input common mode voltage range	V_{ICOM}		0.2		1.7	V
Open-loop gain	A_{VOL}		70	75		dB
Unity-gain bandwidth	f_T			1.2		MHz
Output sink current	I_{FBL}	$V_{FB}=1.0\text{V}$	1.5	2.8		mA
Output source current	I_{FBH}	$V_{FB}=0\text{V}$		-0.25	-0.15	mA

PWM control section

Item	Symbol	Test condition	Min.	Typ.	Max.	Unit
Maximum duty cycle	D_{max}				100	%

Soft-start circuit section 1 (CS1, CS2, CS3/4)

Item	Symbol	Test condition	Min.	Typ.	Max.	Unit
Input threshold voltage	V_{CS0}	Duty cycle=0%		0.78		V
	V_{CS100}	Duty cycle=100%		1.38		V
Charge current	I_{CS}		-7.5	-5.1	-2.5	μA

Soft-start circuit section 2 (CS5, CS6)

Item	Symbol	Test condition	Min.	Typ.	Max.	Unit
Input threshold voltage	V_{CS0}	Duty cycle=0%		0.79		V
	V_{CS100}	Duty cycle=100%		1.40		V
Charge current	I_{CS}			0		μA

Short-circuit protection section

Item	Symbol	Test condition	Min.	Typ.	Max.	Unit
Threshold voltage at CP	V _{CPTH}		1.90	2.16	2.42	V
Charge current at CP	I _{CP}		-3.45	-2.30	-1.15	μA
Threshold voltage at error amplifier output	V _{FCTL}			2.16		V

Overheat protection section

Item	Symbol	Test condition	Min.	Typ.	Max.	Unit
Operating temperature	T _{OH}		125	135	145	°C
Hysteresis width	ΔT _{OH}		45	50	55	°C

ON/OFF logic input section

Item	Symbol	Test condition	Min.	Typ.	Max.	Unit
Input voltage for ON mode	V _{DH}		1.0		5.25	V
Input voltage for OFF mode	V _{DL}		0		0.4	V

Output section 1 (OUT1)

Item	Symbol	Test condition	Min.	Typ.	Max.	Unit
L-level ON resistance	R _{ONL}	I _O =10mA		6	10	Ω
H-level ON resistance	R _{ONH}	I _O =-10mA		6	10	Ω
Rise time	t _r	C _{LOAD} =1000pF		30	50	ns
Fall time	t _f	C _{LOAD} =1000pF		45	70	ns

Output section 2 (OUT2, OUT3, OUT4, OUT5, OUT6a)

Item	Symbol	Test condition	Min.	Typ.	Max.	Unit
L-level ON resistance	R _{ONL}	I _O =10mA		10	15	Ω
H-level ON resistance	R _{ONH}	I _O =-10mA		10	15	Ω
Rise time	t _r	C _{LOAD} =1000pF		40	60	ns
Fall time	t _f	C _{LOAD} =1000pF		55	80	ns

Output section 3 (OUT6b)

Item	Symbol	Test condition	Min.	Typ.	Max.	Unit
ON resistance	R _{ON6b}	I _O =-10mA		1	2	Ω

Overall device

Item	Symbol	Test condition	Min.	Typ.	Max.	Unit
Standby current	I _{CCO}			3	10	μA
Operating-state supply current	I _{CC}	Duty cycle=0%, R _L =∞		4	6	mA

■ Characteristic curves (Ta = 25°C)

Oscillation frequency (fosc) vs. timing resistor resistance (RT)

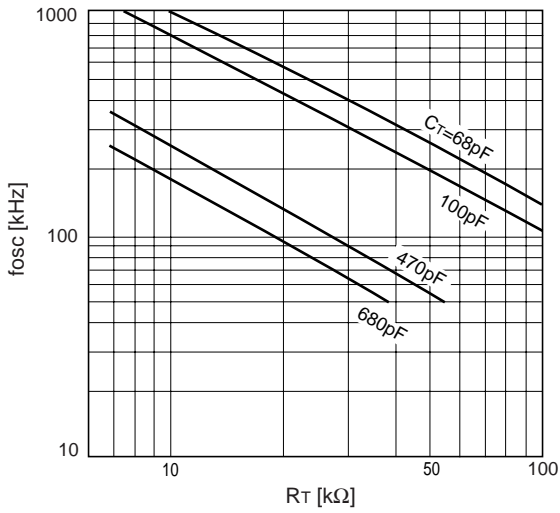

Oscillation frequency (fosc) vs. ambient temperature (Ta)

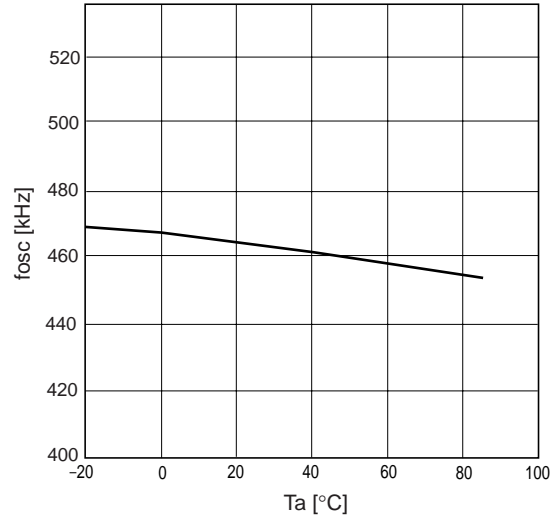

Output duty cycle vs. CS terminal voltage (Vcs)

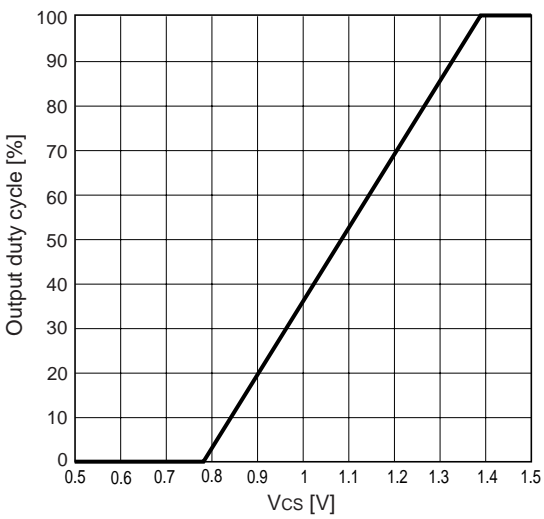

Output duty cycle vs. FB terminal voltage (VFB)

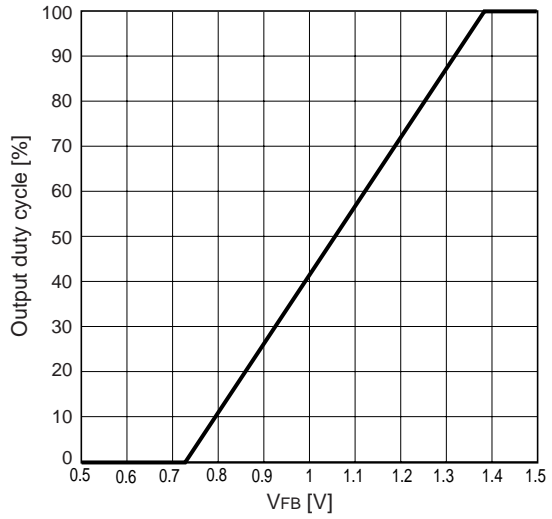

Reference voltage (VREF) vs. ambient temperature (Ta)

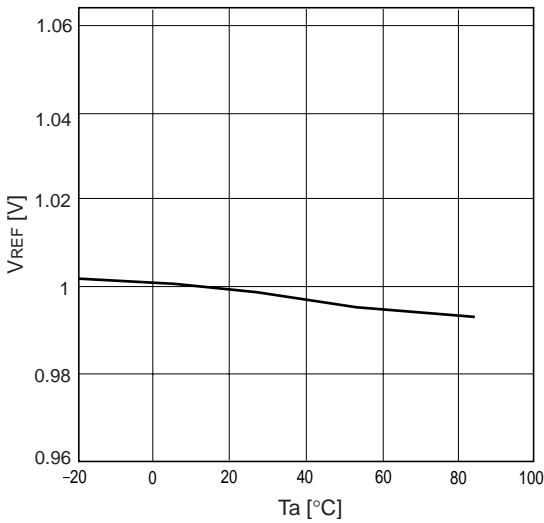

Supply current (Icc) vs. Supply voltage (Vcc)

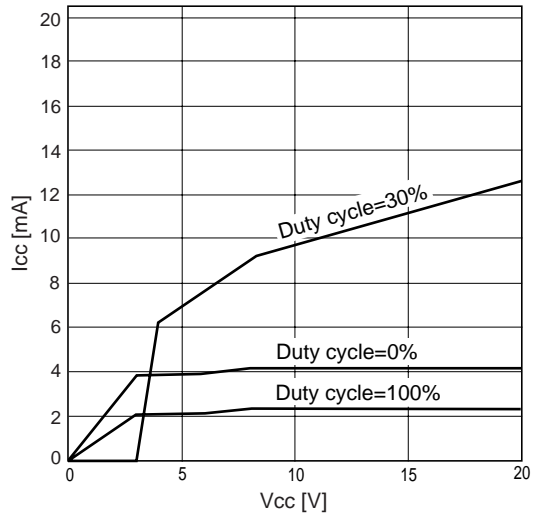

H-level output voltage ($V_{CC-V_{OH}}$) vs. output source current (I_{SOURCE}) for OUT1

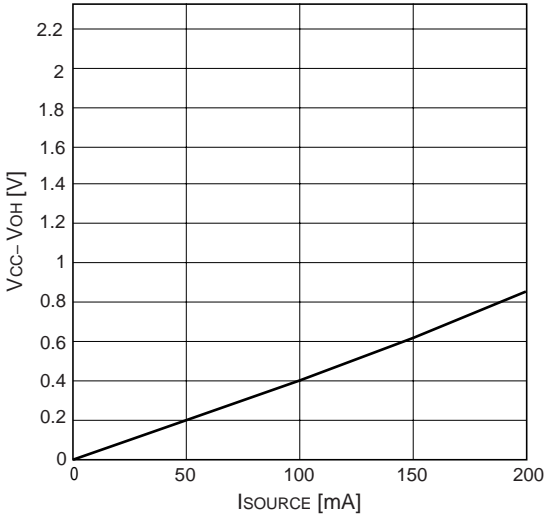

L-level output voltage (V_{OL}) vs. output sink current (I_{SINK}) for OUT1

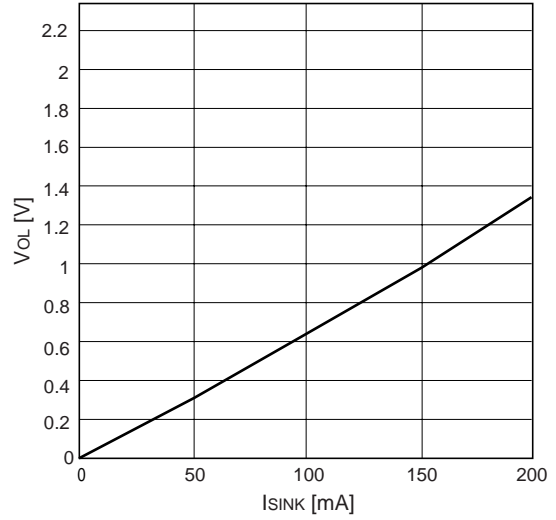

H-level output voltage ($V_{CC-V_{OH}}$) vs. output source current (I_{SOURCE}) for OUT2, 3, 4, 5, 6a

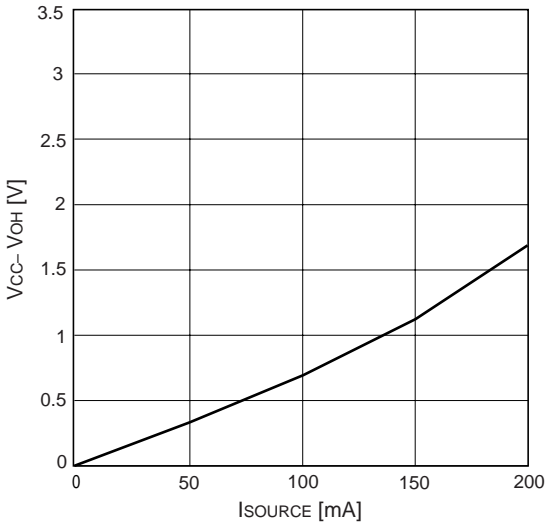

L-level output voltage (V_{OL}) vs. output sink current (I_{SINK}) for OUT2, 3, 4, 5, 6a

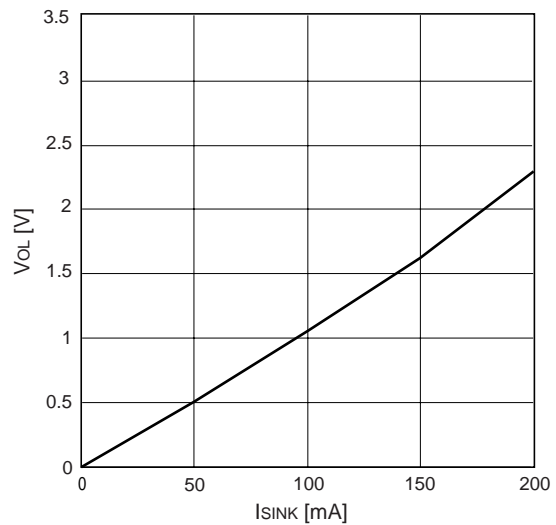

H-level output voltage ($V_{CC-V_{OH}}$) vs. output source current (I_{SOURCE}) for OUT6b

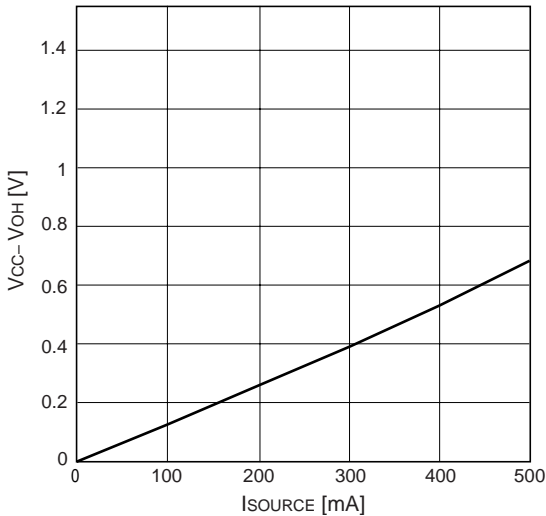

Error amplifier voltage gain (A_v) / phase (θ) vs. frequency (f)

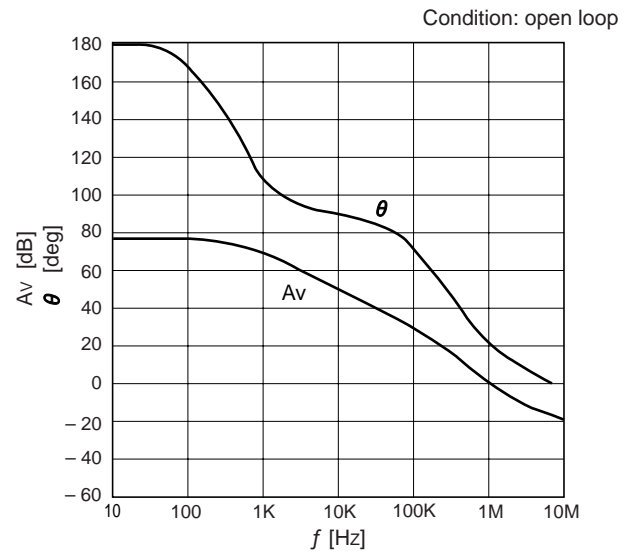

■ Application circuit

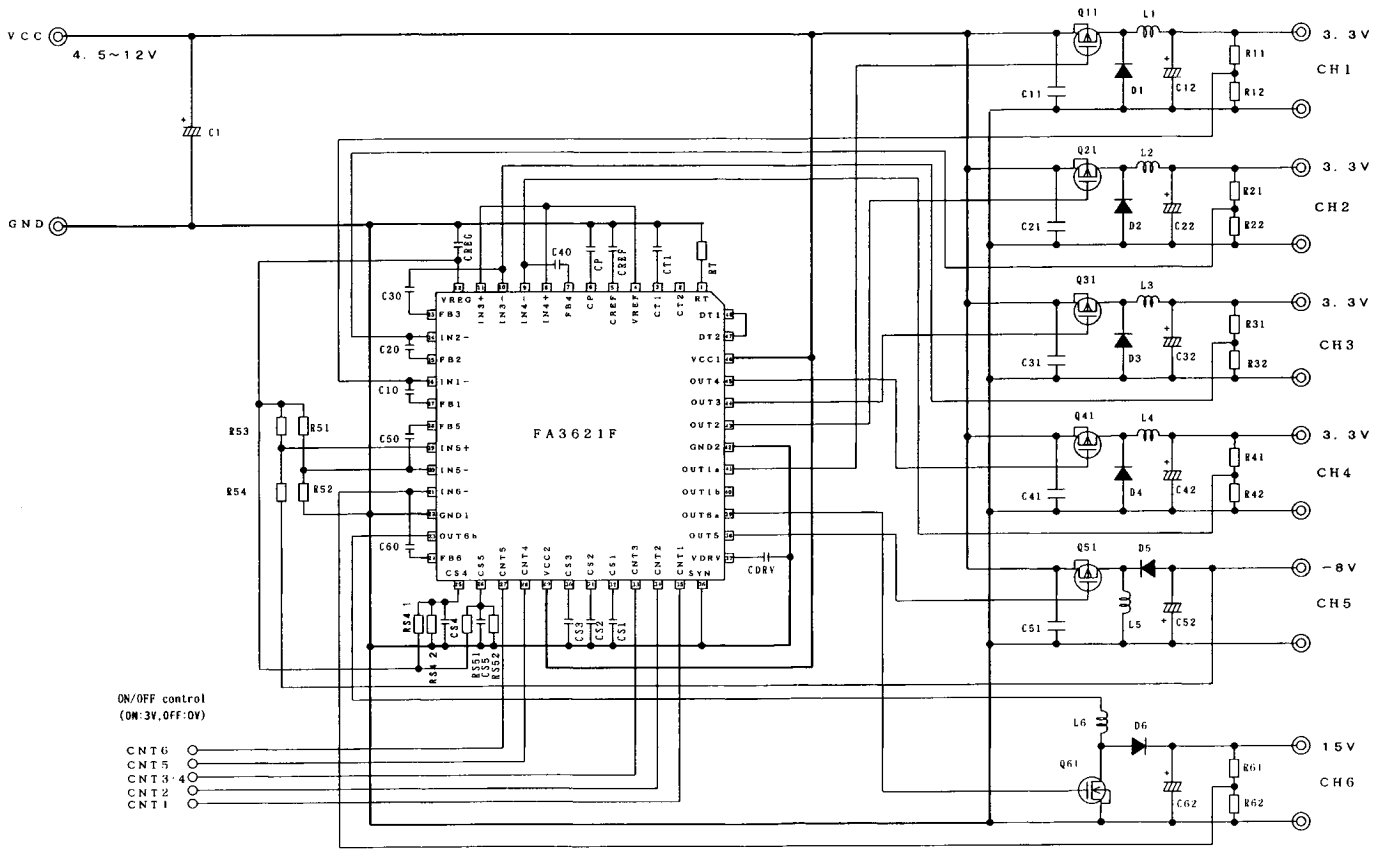

Parts tolerances characteristics are not defined in the circuit design sample shown above. When designing an actual circuit for a product, you must determine parts tolerances and characteristics for safe and economical operation.