

SPECIFICATION

Device Name : IGBT Module

Type Name : 7MBR75SB060-01

Spec. No. : MS6M 0552

Date : Jun. - 02 - 2000

This material and the information herein is the property of Fuji Electric Co. Ltd. They shall be neither reproduced, copied, lent, or disclosed in any way whatsoever for the use of any third party nor used for the manufacturing purposes without the express written consent of Fuji Electric Co. Ltd.

Fuji Electric Co., Ltd.
Matsumoto Factory

	DATE	NAME	APPROVED	Fuji Electric Co., Ltd.	
DRAWN	Jan. - 2 - '00	<i>Y. Kobayashi</i>		DWG. NO.	MS6M 0552
CHECKED	June - 2 - 00	<i>S. Maki</i>	<i>T. Mizusaki</i>		

7MBR75SB060-01

1. Outline Drawing (Unit : mm)

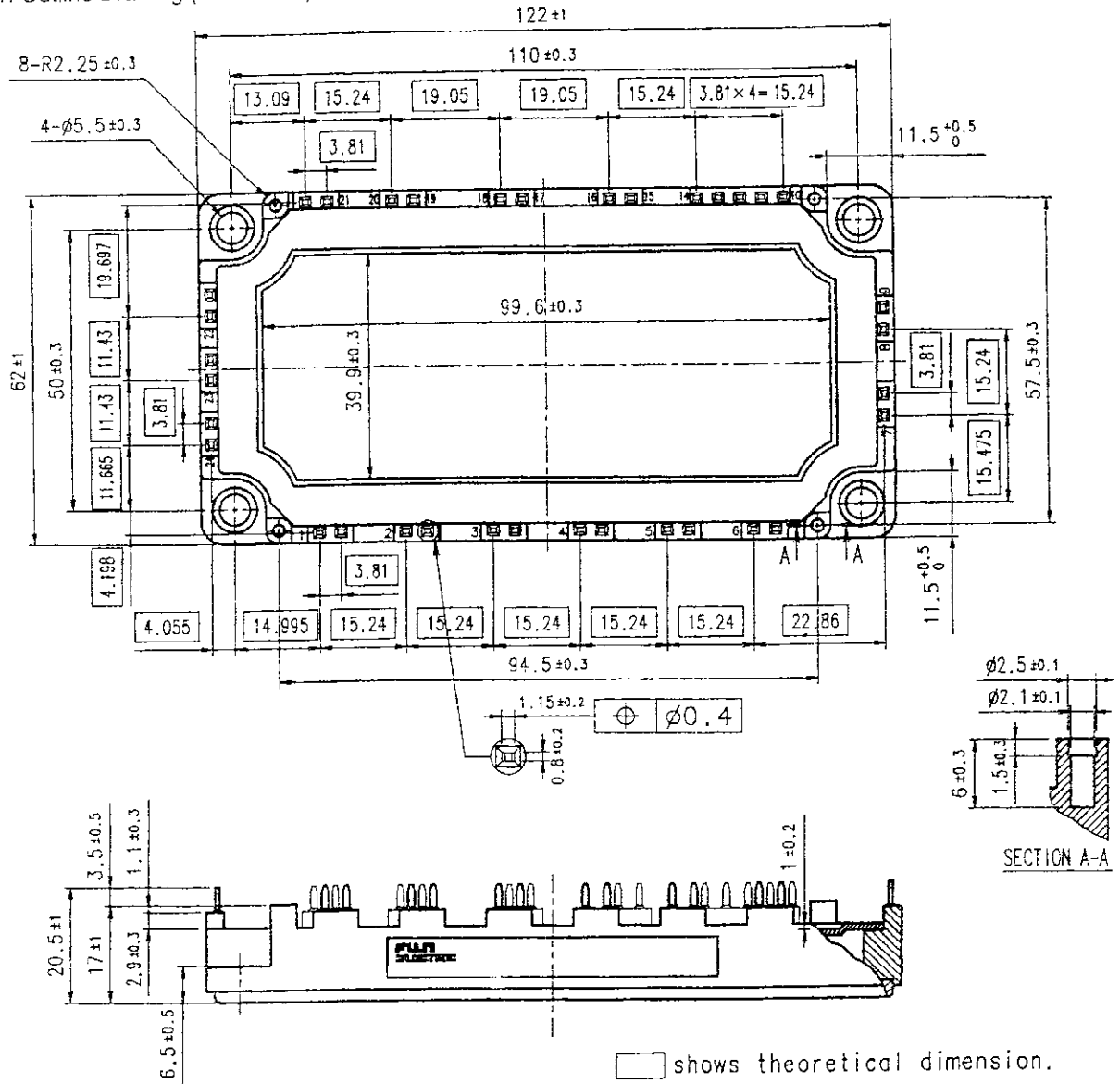

This material and the information herein is the property of Fuji Electric Co. Ltd. They shall be neither reproduced, copied, lent, or disclosed in any way whatsoever for the use of any third party nor used for the manufacturing purposes without the express written consent of Fuji Electric Co., Ltd.

2. Equivalent circuit

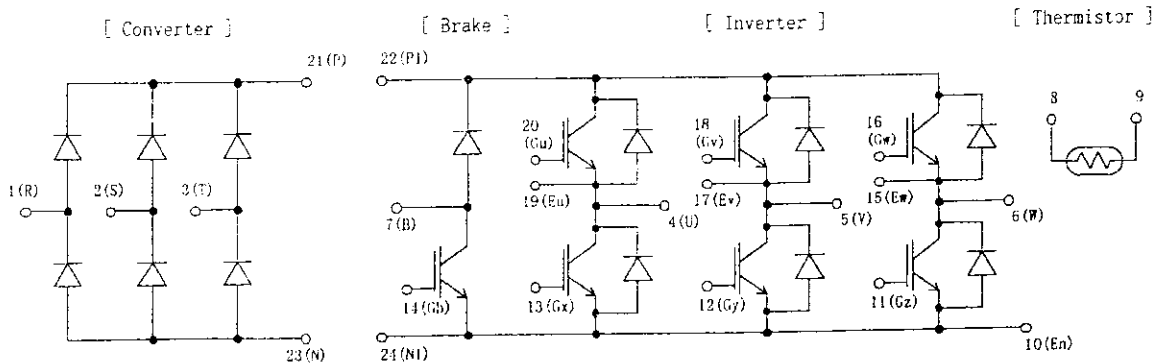

Fuji Electric Co., Ltd.

DWG. NO.

MS6M 0552

3 / 10

H04-004-03

3. Absolute Maximum Ratings (at Tc= 25°C unless otherwise specified)

Items		Symbols	Conditions	Maximum Ratings	Units
Inverter	Collector-Emitter voltage	V _{CEs}		600	V
	Gate-Emitter voltage	V _{GES}		±20	V
	Collector current	I _c	Continuous	75	A
		I _{cp}	1ms	50	A
		-I _c		75	A
Collector Power Dissipation	P _c	1 device	300	W	
Brake	Collector-Emitter voltage	V _{CEs}		600	V
	Gate-Emitter voltage	V _{GES}		±20	V
	Collector current	I _c	Continuous	50	A
		I _{cp}	1ms	100	A
	Collector Power Dissipation	P _c	1 device	200	W
Repetitive peak reverse Voltage (Diode)	V _{RRM}		600	V	
Converter	Repetitive peak reverse Voltage	V _{RRM}		800	V
	Average Output Current	I _o	50Hz/60Hz sine wave	75	A
	Surge Current (Non-Repetitive)	I _{FSM}	T _j =150°C, 10ms	525	A
	I ² t (Non-Repetitive)	I ² t	half sine wave	1378	A ² s
Junction temperature	T _j		150	°C	
Storage temperature	T _{stg}		-40~ +125	°C	
Isolation voltage	between terminal and copper base ^{(*)1}	Viso	AC : 1min.	2500	V
	between thermistor and others ^{(*)2}			2500	V
Mounting Screw Torque ^{(*)3}				3.5	N·m

(*1) All terminals should be connected together when isolation test will be done.

(*2) Terminal 8 and 9 should be connected together. Terminal 1 to 7 and 10 to 24 should be connected together and shorted to copper base.

(*3) Recommendable Value : 2.5~3.5 N·m (M5)

This material and the information herein is the property of Fuji Electric Co. Ltd. They shall be neither reproduced, copied, lent, or disclosed in any way whatsoever for the use of any third party, nor used for the manufacturing purposes without the express written consent of Fuji Electric Co., Ltd.

Fuji Electric Co., Ltd.

DWG. NO.

MS6M 0552

4 / 10

H04-004-03

4. Electrical characteristics (at Tj= 25C unless otherwise specified)

Items	Symbols	Conditions	Characteristics			Units
			min.	typ.	Max.	
Inverter	Zero gate voltage Collector current	ICES VGE 0 V, VCE 600 V			1.0	mA
	Gate-Emitter leakage current	IGES VCE 0 V, VGE +20 V			200	nA
	Gate-Emitter threshold voltage	VGE(th) VCE 20 V, Ic = 75 m	5.5	7.8	8.5	V
	Collector-Emitter saturation voltage	VCE(sat) VGE 15 V, chip Ic = 75 A terminal		1.8		V
				2.1	2.55	
	Input capacitance	Cies VGE 0 V, VCE 10 V f = 1 MHz		7500		pF
	Turn-on time	ton Vcc= 300 V		0.45	1.2	us
		tr Ic = 75 A		0.25	0.6	
		tr(0) VGE +-15 V		0.08		
	Turn-off time	toff RG = 33 ohm		0.40	1.0	us
tf			0.05	0.35		
Forward on voltage	VF IF = 75 A chip terminal		1.7		V	
			2.0	2.7		
Reverse recovery time	trr IF = 75 A			300	ns	
Brake	Zero gate voltage Collector current	ICES VGE 0 V, VCE 600 V			1.0	mA
	Gate-Emitter leakage current	IGES VCE 0 V, VGE +20 V			200	nA
	Collector-Emitter saturation voltage	VCE(sat) VGE 15 V, chip Ic = 50 A terminal		1.8		V
				2.05	2.5	
	Turn-on time	ton Vcc= 300 V		0.45	1.2	us
		tr Ic = 50 A		0.25	0.6	
	Turn-off time	toff VGE +-15 V		0.40	1.0	us
		tf RG = 51 ohm		0.05	0.35	
	Reverse current	IRRM VR = 600 V			1.0	mA
	Converter	VFM IF = 75 A chip terminal		1.1		V
			1.2	1.5		
Reverse current	IRRM VR = 800 V			1.0	mA	
Thermistor	R	T = 25C		5000		ohm
		T = 100C	465	495	520	
B value	B	T = 25/50C	3305	3375	3450	K

This material and the information herein is the property of Fuji Electric Co. Ltd. They shall be neither reproduced, copied, nor disclosed in any way whatsoever for the use of any third party nor used for the manufacturing purposes without the express written consent of Fuji Electric Co., Ltd.

5. Thermal resistance characteristics

Items	Symbols	Conditions	Characteristics			Units
			min.	typ.	Max.	
Thermal resistance (1 device)	Rth(j-c)	Inverter IGBT			0.42	C/W
		Inverter FWD			0.90	
		Brake IGBT			0.63	
		Converter Diode			0.70	
Contact Thermal resistance	Rth(c-f)	with Thermal Compound (*)		0.05		C/W

* This is the value which is defined mounting on the additional cooling fin with thermal compound.

Fuji Electric Co.,Ltd.

DWG NO.

MS6M 0552

5/10

H04-004-03

This material and the information herein is the property of Fuji Electric Co. Ltd. They shall be neither reproduced, copied, lent, or disclosed in any way whatsoever for the use of any third party nor used for the manufacturing purposes without the express written consent of Fuji Electric Co., Ltd.

6. Indication on module

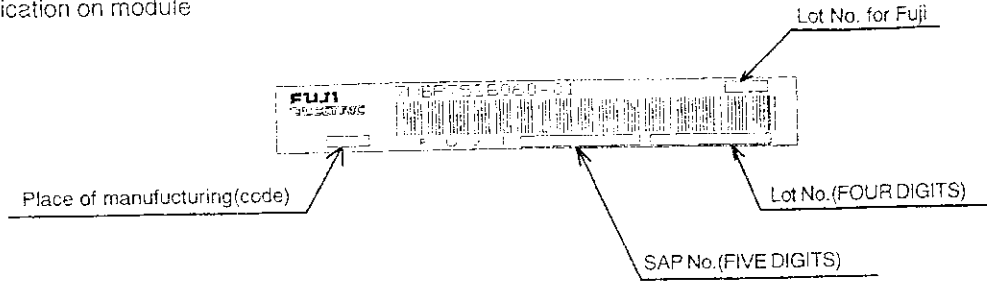

7. Applicable category

This specification is applied to Power Integrated Module named 7MBR75SB060-01.

8. Storage and transportation notes

- The module should be stored at a standard temperature of 5 to 35°C and humidity of 45 to 75% .
- Store modules in a place with few temperature changes in order to avoid condensation on the module surface.
- Avoid exposure to corrosive gases and dust.
- Avoid excessive external force on the module.
- Store modules with unprocessed terminals.
- Do not drop or otherwise shock the modules when transporting.
- Please connect adequate fuse or protector of circuit between three-phase line and this product to prevent the equipment from causing secondary destruction.

9. Definitions of switching time

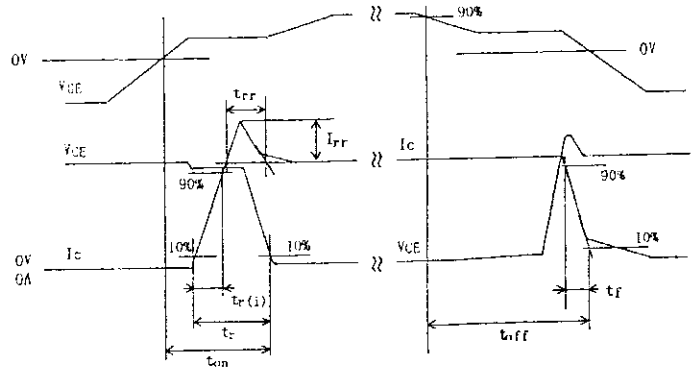
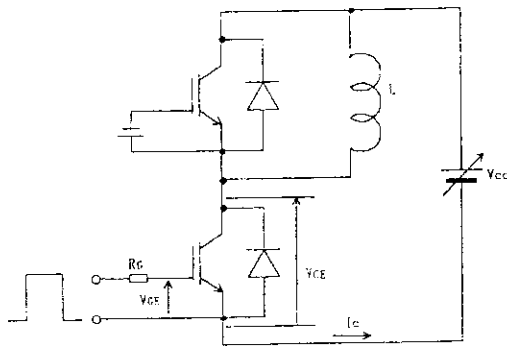

Fuji Electric Co., Ltd.

DWG. NO.

MS6M 0552

6 / 10

H04-004-03

This material and the information herein is the property of Fuji Electric Co. Ltd. They shall be neither reproduced, copied, lent, or disclosed in any way whatsoever for the use of any third party nor used for the manufacturing purposes without the express written consent of Fuji Electric Co. Ltd.

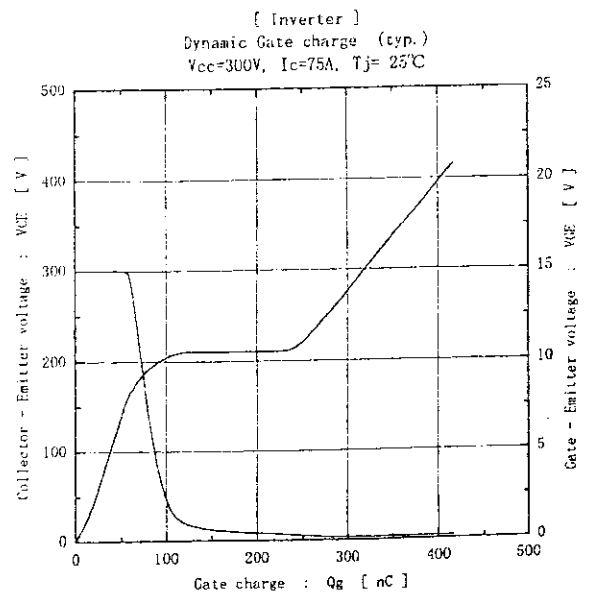
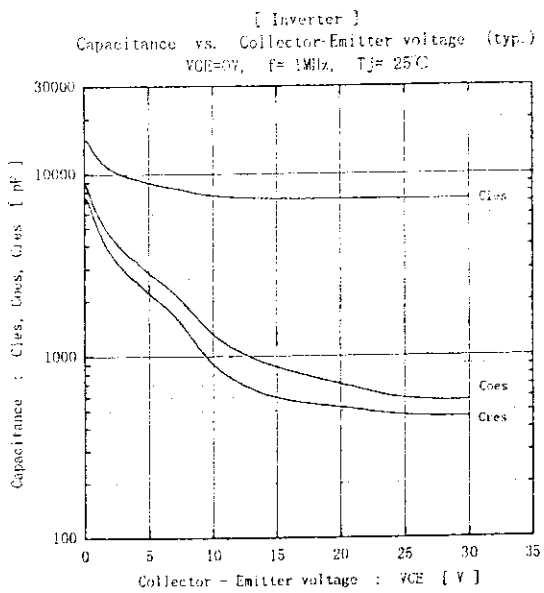
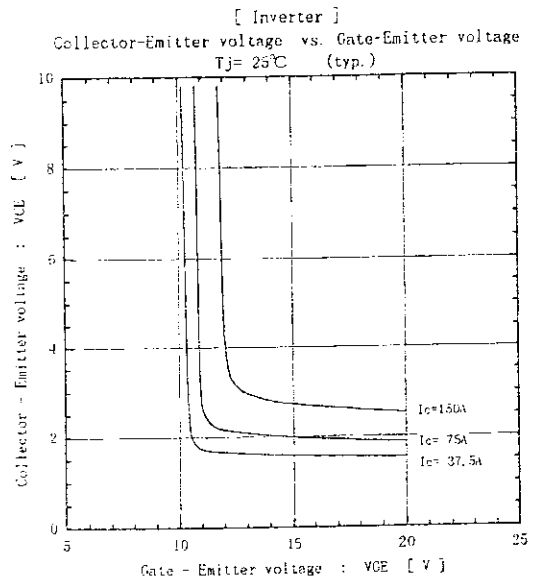
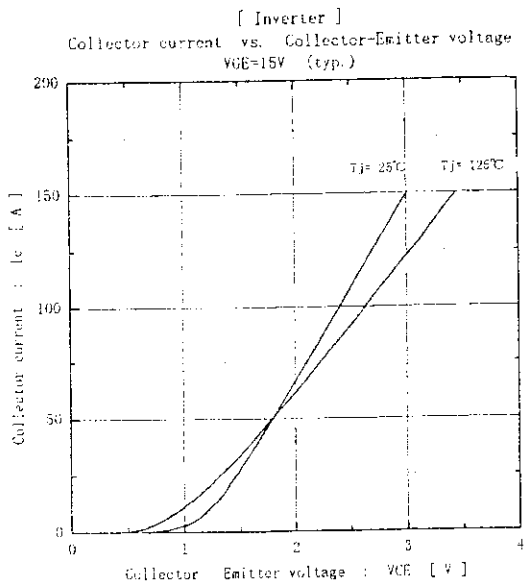
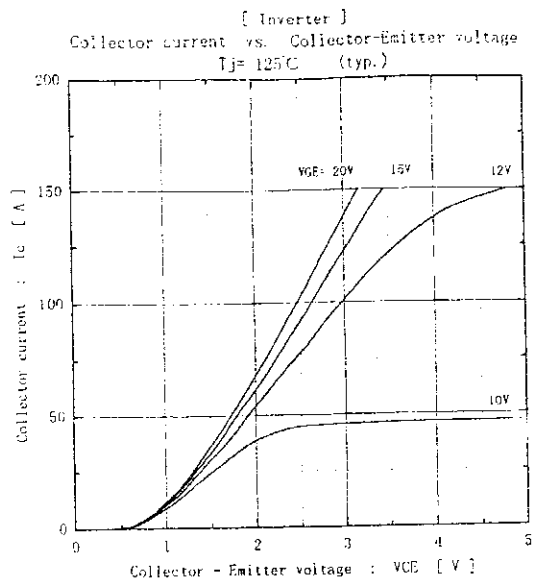
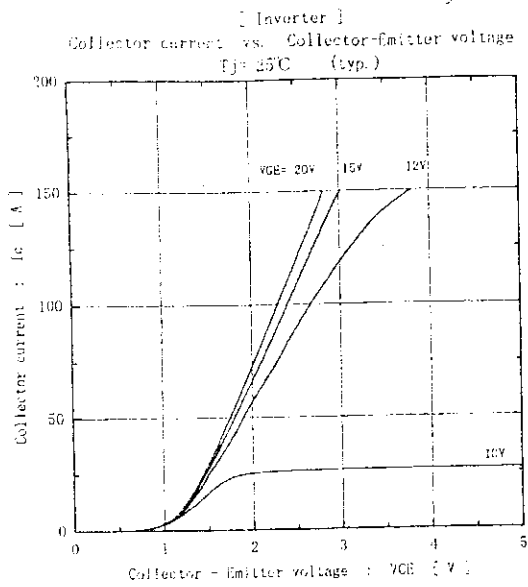

Fuji Electric Co., Ltd.

DWG. NO.

MS6M 0552

7/10

H04-004-03

This material and the information herein is the property of Fuji Electric Co. Ltd. They shall be neither reproduced, copied, lent, or disposed in any way whatsoever for the use of any third party nor used for the manufacturing purposes without the express written consent of Fuji Electric Co., Ltd.

[Inverter]
Switching time vs. Collector current (typ.)
 $V_{cc}=300V, V_{GE}=\pm 15V, R_g=33\Omega, T_j=25^\circ C$

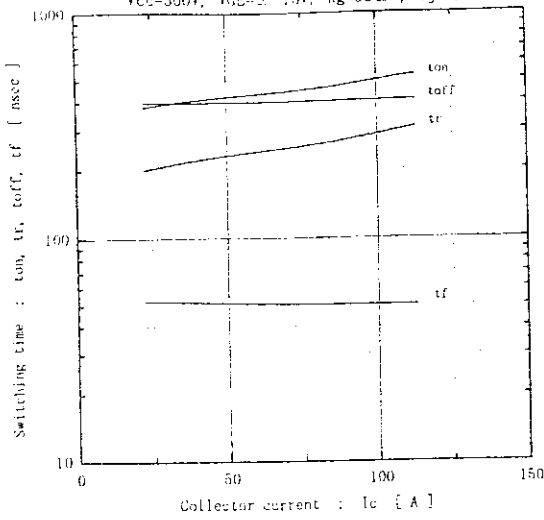

[Inverter]
Switching time vs. Collector current (typ.)
 $V_{cc}=300V, V_{GE}=\pm 15V, R_g=33\Omega, T_j=125^\circ C$

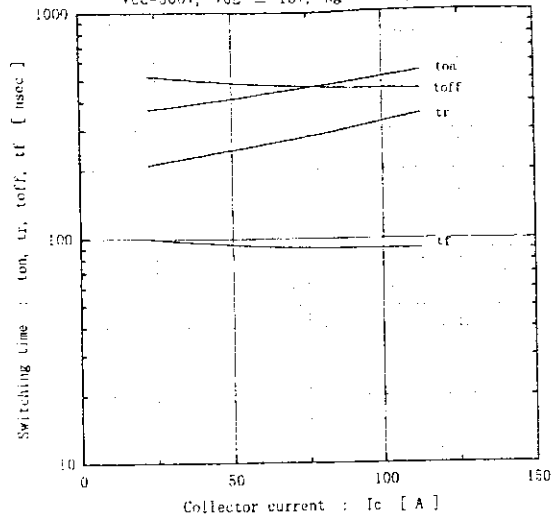

[Inverter]
Switching time vs. Gate resistance (typ.)
 $V_{cc}=300V, I_c=75A, V_{GE}=\pm 15V, T_j=25^\circ C$

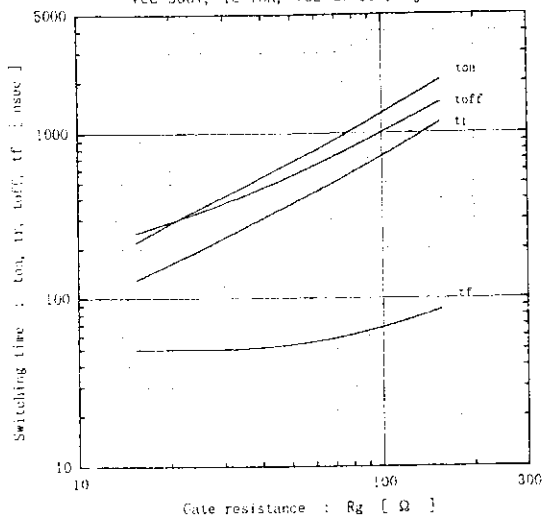

[Inverter]
Switching loss vs. Collector current (typ.)
 $V_{cc}=300V, V_{GE}=\pm 15V, R_g=33\Omega$

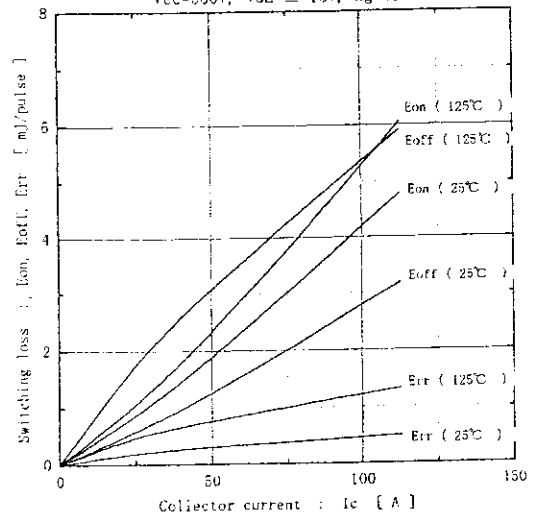

[Inverter]
Switching loss vs. Gate resistance (typ.)
 $V_{cc}=300V, I_c=75A, V_{GE}=\pm 15V, T_j=125^\circ C$

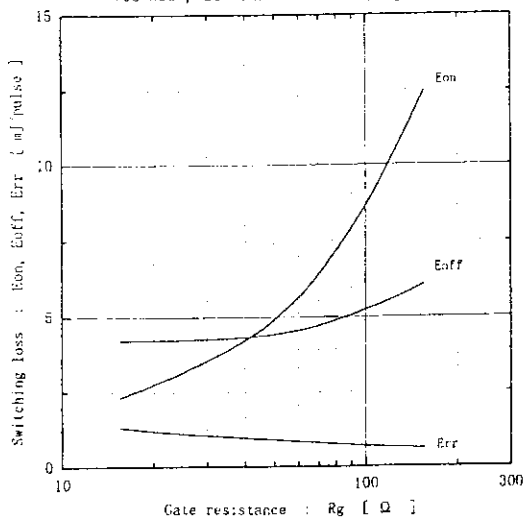

[Inverter]
Reverse bias safe operating area
 $+V_{GE}=15V, -V_{GE}\le 15V, R_g\ge 33\Omega, T_j\le 125^\circ C$

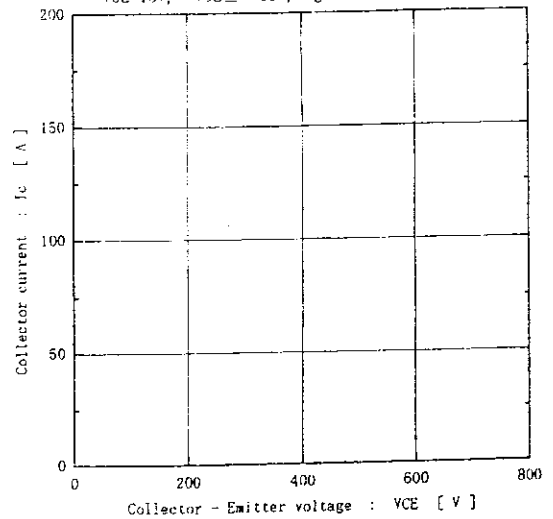

Fuji Electric Co.,Ltd.

DWG.NO.

MS6M 0552

8/10

This material and the information herein is the property of Fuji Electric Co. Ltd. They shall be neither reproduced, copied, lent, or disclosed in any way whatsoever for the use of any third party nor used for the manufacturing purposes without the express written consent of Fuji Electric Co. Ltd.

[Inverter]
Forward current vs. Forward on voltage (typ.)

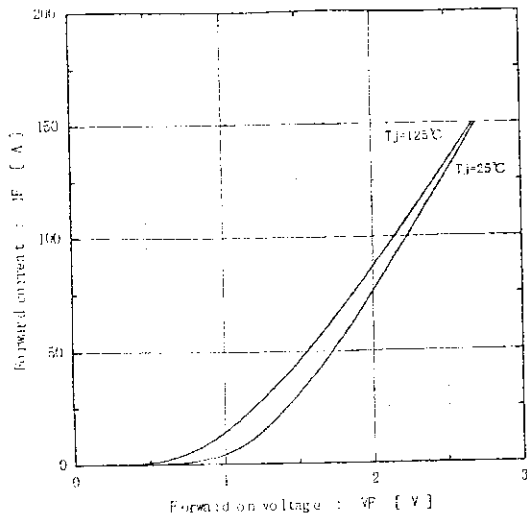

[Inverter]
Reverse recovery characteristics (typ.)
V_{ce}=120V, V_{GE}±15V, R_θ=33Ω

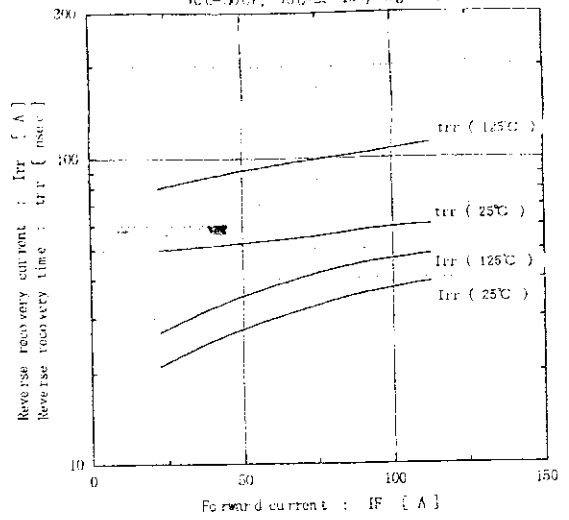

[Converter]
Forward current vs. Forward on voltage (typ.)

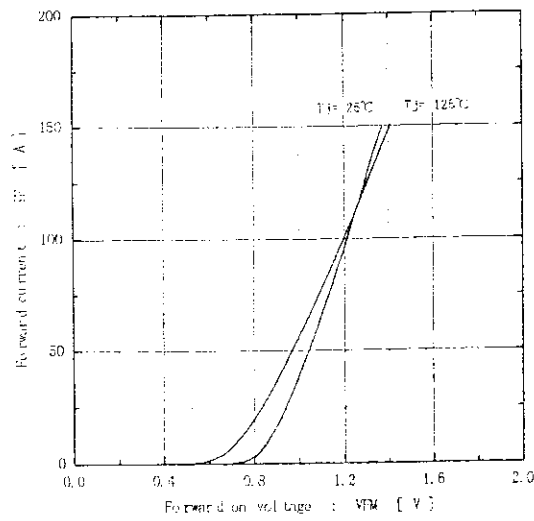

Transient thermal resistance

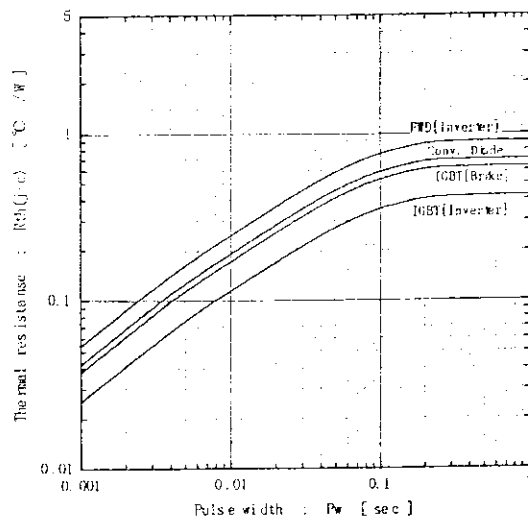

[Thermistor]
Temperature characteristic (typ.)

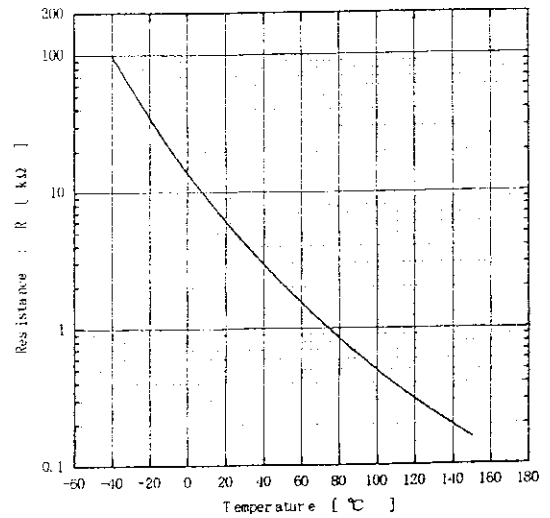

Fuji Electric Co., Ltd.

DWG. NO.

MS6M 0552

9 / 10

H04-004-03

This material and the information herein is the property of Fuji Electric Co. Ltd. They shall be neither reproduced, copied, lent, or disclosed in any way whatsoever for the use of any third party nor used for the manufacturing purposes without the express written consent of Fuji Electric Co., Ltd.

[Brake]
 Collector current vs. Collector-Emitter voltage
 $T_j = 25^\circ\text{C}$ (typ.)

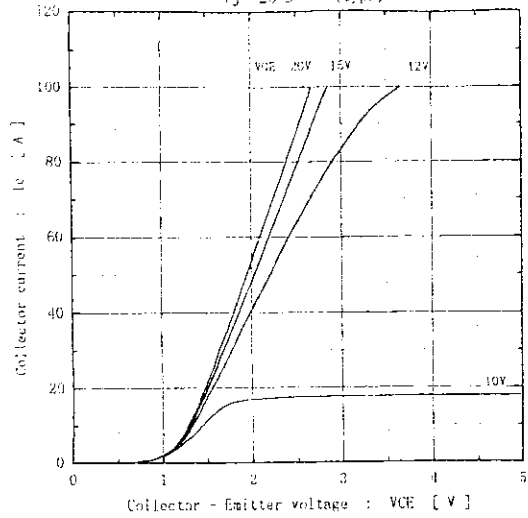

[Brake]
 Collector current vs. Collector-Emitter voltage
 $T_j = 125^\circ\text{C}$ (typ.)

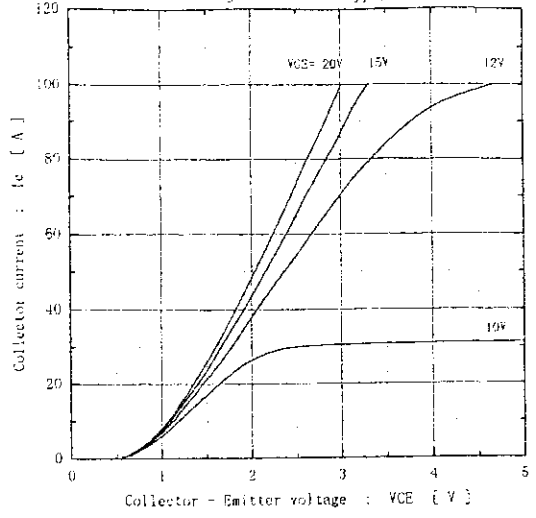

[Brake]
 Collector current vs. Collector-Emitter voltage
 $V_{GE} = 15\text{V}$ (typ.)

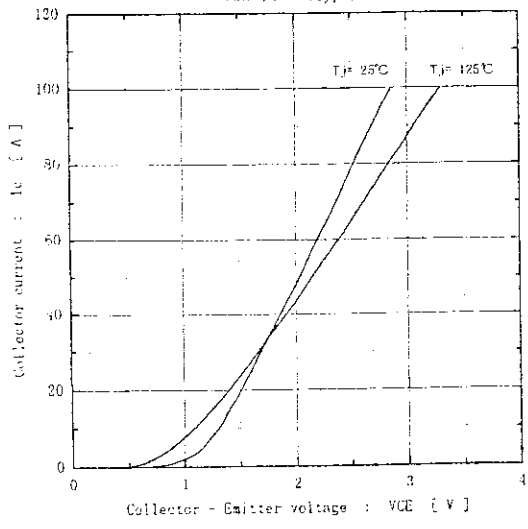

[Brake]
 Collector-Emitter voltage vs. Gate-Emitter voltage
 $T_j = 25^\circ\text{C}$ (typ.)

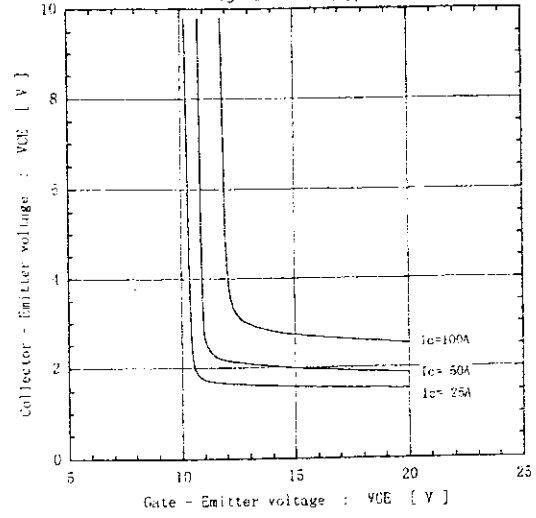

[Brake]
 Capacitance vs. Collector-Emitter voltage (typ.)
 $V_{GE} = 0\text{V}$, $f = 1\text{MHz}$, $T_j = 25^\circ\text{C}$

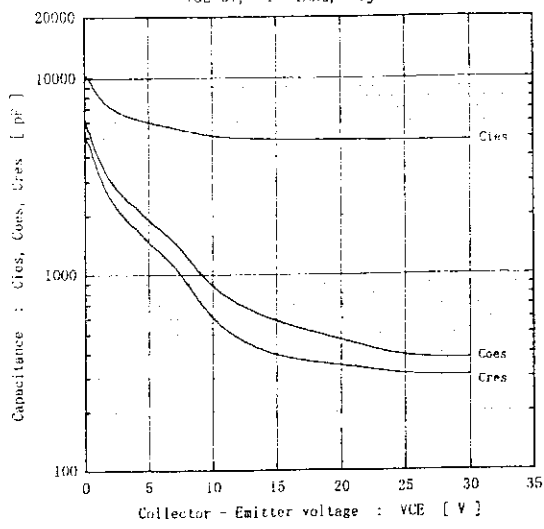

[Brake]
 Dynamic Gate charge (typ.)
 $V_{CC} = 300\text{V}$, $I_c = 50\text{A}$, $T_j = 25^\circ\text{C}$

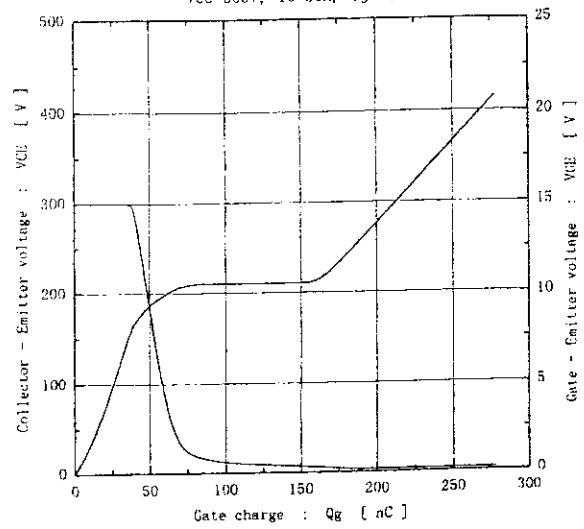

Fuji Electric Co., Ltd.

DWG. NO.

MS6M 0552

10 / 10

H04-004-03