

SPECIFICATION

Device Name : IGBT Module

Type Name : 7MBR35SB120-01

Spec. No. : MS6M 0554

Date : Jun. - 02 - 2000

This material and the information herein is the property of Fuji Electric Co., Ltd. They shall be neither reproduced, copied, lent, or disclosed in any way whatsoever for the use of any third party nor used for the manufacturing purposes without the express written consent of Fuji Electric Co., Ltd.

Fuji Electric Co., Ltd.
Matsumoto Factory

| | DATE | NAME | APPROVED | Fuji Electric Co., Ltd. | | |
|---------|----------------|---------------------|---------------------|-------------------------|-----------|--------|
| DRAWN | Jun. - 2 - '00 | <i>T. Kobayashi</i> | <i>T. Kobayashi</i> | DWG. NO. | MS6M 0554 | 1 / 10 |
| CHECKED | June - 2 - 00 | <i>S. Matsu</i> | | | | 0 |

3. Absolute Maximum Ratings (at Tc= 25C unless otherwise specified)

| Items | | Symbols | Conditions | Maximum Ratings | Units | |
|--|---|------------------|------------------------|-----------------|-------|------------------|
| Inverter | Collector-Emitter voltage | VCES | | 1200 | V | |
| | Gate-Emitter voltage | VGES | | +20 | V | |
| | Collector current | Ic | Continuous | Tc=25C | 50 | A |
| | | | | Tc=80C | 35 | |
| | | Icp | 1ms | Tc=25C | 100 | A |
| | | | | Tc=80C | 70 | |
| | -Ic | | | 35 | A | |
| Collector Power Dissipation | Pc | 1 device | | 240 | W | |
| Brake | Collector-Emitter voltage | VCES | | 1200 | V | |
| | Gate-Emitter voltage | VGES | | +20 | V | |
| | Collector current | Ic | Continuous | Tc=25C | 35 | A |
| | | | | Tc=80C | 25 | |
| | | Icp | 1ms | Tc=25C | 70 | A |
| | | | | Tc=80C | 50 | |
| Collector Power Dissipation | Pc | 1 device | | 180 | W | |
| Repetitive peak reverse Voltage(Diode) | VRRM | | | 1200 | V | |
| Converter | Repetitive peak reverse Voltage | VRRM | | 1600 | V | |
| | Average Output Current | Io | 50Hz/60Hz sine wave | 35 | A | |
| | Surge Current (Non-Repetitive) | IFSM | Tj=150C,10ms | 360 | A | |
| | I ² t (Non-Repetitive) | I ² t | half sine wave | | 648 | A ² s |
| | | | | | | |
| Junction temperature | Tj | | | 150 | C | |
| Storage temperature | Tstg | | | -40~ +125 | C | |
| Isolation voltage | between terminal and copper base ^(*) | Viso | AC : 1min. | 2500 | V | |
| | between thermistor and others ^(*) | | | 2500 | | |
| Mounting Screw Torque ^(*) | | | | 3.5 | Nm | |

(*1) All terminals should be connected together when isolation test will be done.

(*2) Terminal 8 and 9 should be connected together. Terminal 1 to 7 and 10 to 24 should be connected together and shorted to copper base.

(*3) Recommendable Value : 2.5~3.5 Nm (M5)

MS6M 0554

4 / 10

4. Electrical characteristics (at Tj= 25C unless otherwise specified)

| Items | Symbols | Conditions | Characteristics | | | Units | | | |
|-----------------------|--------------------------------------|-------------|-----------------------------------|----------|------|-------|------|------|-----|
| | | | min. | typ. | Max. | | | | |
| Inverter | Zero gate voltage Collector current | ICES | VGE = 0 V, VCE= 1200 V | | | 1.0 | mA | | |
| | Gate-Emitter leakage current | IGES | VCE = 0 V, VGE= +20 V | | | 200 | nA | | |
| | Gate-Emitter threshold voltage | VGE(th) | VCE = 20 V, Ic = 35 mA | | | 5.5 | 7.2 | 8.5 | V |
| | Collector-Emitter saturation voltage | VCE(sat) | VGE = 15 V, chip | | | 2.1 | | V | |
| | | | Ic = 35 A terminal | | | 2.25 | 2.7 | | |
| | Input capacitance | Cies | VGE = 0 V, VCE= 10 V f = 1 MHz | | | 4200 | | pF | |
| | Turn-on time | ton | Vcc= 600 V | | | 0.35 | 1.2 | us | |
| | | tr | Ic = 35 A | | | 0.25 | 0.6 | | |
| | | tr(θ) | VGE = +15 V | | | 0.1 | | | |
| | Turn-off time | toff | RG = 33 ohm | | | 0.45 | 1.0 | | |
| tf | | | | | 0.08 | 0.3 | | | |
| Forward on voltage | VF | IF = 35 A | chip | | | 2.3 | | V | |
| | | | terminal | | | 2.45 | 3.3 | | |
| Reverse recovery time | trr | IF = 35 A | | | | 350 | ns | | |
| Brake | Zero gate voltage Collector current | ICES | VGE = 0 V, VCE = 1200 V | | | 1.0 | mA | | |
| | Gate-Emitter leakage current | IGES | VCE = 0 V, VGE = +20 V | | | 200 | nA | | |
| | Collector-Emitter saturation voltage | VCE(sat) | VGE = 15 V, chip | | | 2.1 | | V | |
| | | | Ic = 25 A terminal | | | 2.25 | 2.7 | | |
| | Turn-on time | ton | Vcc= 600 V | | | 0.35 | 1.2 | us | |
| | | tr | Ic = 25 A | | | 0.25 | 0.6 | | |
| | Turn-off time | toff | VGE = +15 V | | | 0.45 | 1.0 | | |
| tf | | RG = 51 ohm | | | 0.08 | 0.3 | | | |
| Reverse current | IRRM | VR = 1200 V | | | | 1.0 | mA | | |
| Converter | Forward on voltage | VFM | IF = 35 A | chip | | | 1.1 | V | |
| | | | | terminal | | | 1.2 | | 1.5 |
| Reverse current | IRRM | VR = 1600 V | | | | 1.0 | mA | | |
| Thermistor | Resistance | R | T = 25C | | | 5000 | | ohm | |
| | | | T = 100C | | | 465 | 495 | | 520 |
| | B value | B | T = 25/50C | | | 3305 | 3375 | 3450 | K |

This material and the information herein is the property of Fuji Electric Co., Ltd. They shall be neither reproduced, copied, lent, or disclosed in any way whatsoever for the use of any third party nor used for the manufacturing purposes without the express written consent of Fuji Electric Co., Ltd.

5. Thermal resistance characteristics

| Items | Symbols | Conditions | Characteristics | | | Units |
|----------------------------------|----------|---------------------------|-----------------|------|------|-------|
| | | | min. | typ. | Max. | |
| Thermal resistance (1 device) | Rth(j-c) | Inverter IGBT | | | 0.52 | C/W |
| | | Inverter FWD | | | 0.90 | |
| | | Brake IGBT | | | 0.69 | |
| | | Converter Diode | | | 0.75 | |
| Contact Thermal resistance | Rth(c-f) | with Thermal Compound (*) | | 0.05 | | C/W |

* This is the value which is defined mounting on the additional cooling fin with thermal compound.

Fuji Electric Co., Ltd.

DWG. NO.

MS6M 0554

5 / 10

| |
|---|
| □ |
| □ |
| □ |

6. Indication on module

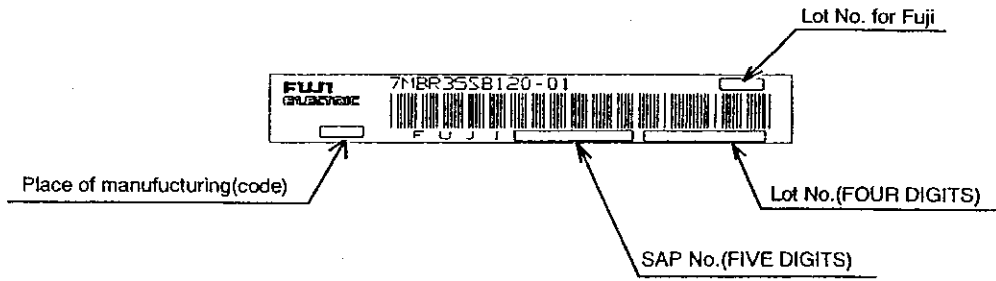

7. Applicable category

This specification is applied to Power Integrated Module named 7MBR35SB120-01 .

8. Storage and transportation notes

- The module should be stored at a standard temperature of 5 to 35°C and humidity of 45 to 75% .
- Store modules in a place with few temperature changes in order to avoid condensation on the module surface.
- Avoid exposure to corrosive gases and dust.
- Avoid excessive external force on the module.
- Store modules with unprocessed terminals.
- Do not drop or otherwise shock the modules when transporting.
- Please connect adequate fuse or protector of circuit between three-phase line and this product to prevent the equipment from causing secondary destruction.

This material and the information herein is the property of Fuji Electric Co., Ltd. They shall be neither reproduced, copied, lent, or disclosed in any way whatsoever for the use of any third party nor used for the manufacturing purposes without the express written consent of Fuji Electric Co., Ltd.

9. Definitions of switching time

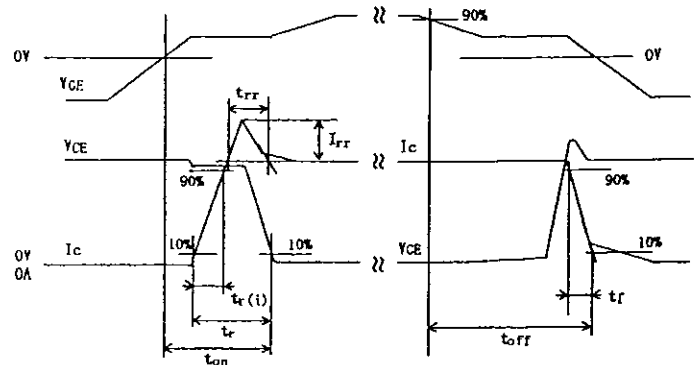
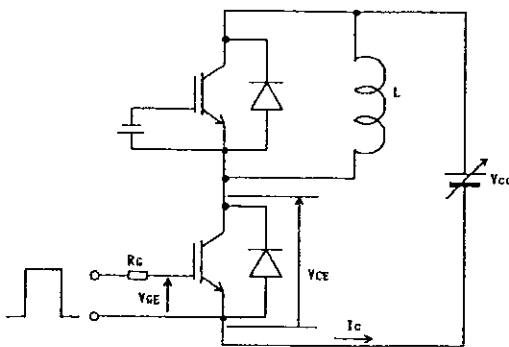

Fuji Electric Co., Ltd.

DWG. NO.

MS6M 0554

6 / 10

| |
|---|
| α |
| |
| |
| |

This material and the information herein is the property of Fuji Electric Co., Ltd. They shall be neither reproduced, copied, lent, or disclosed in any way whatsoever for the use of any third party nor used for the manufacturing purposes without the express written consent of Fuji Electric Co., Ltd.

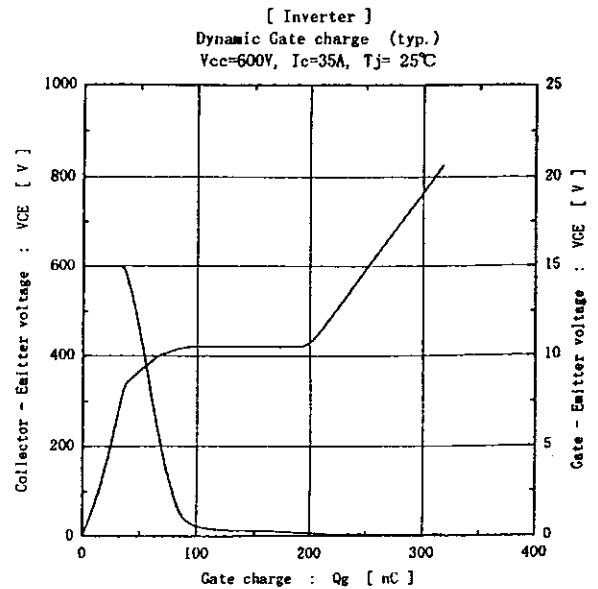
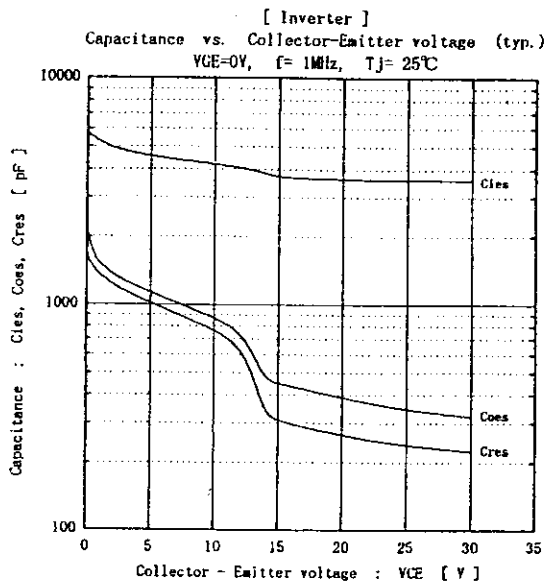
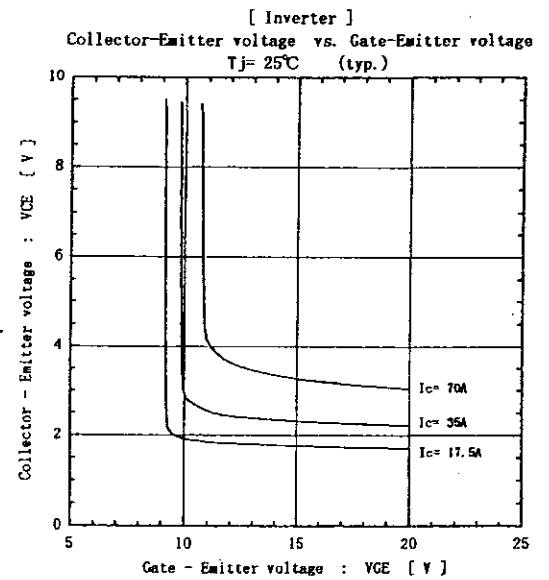
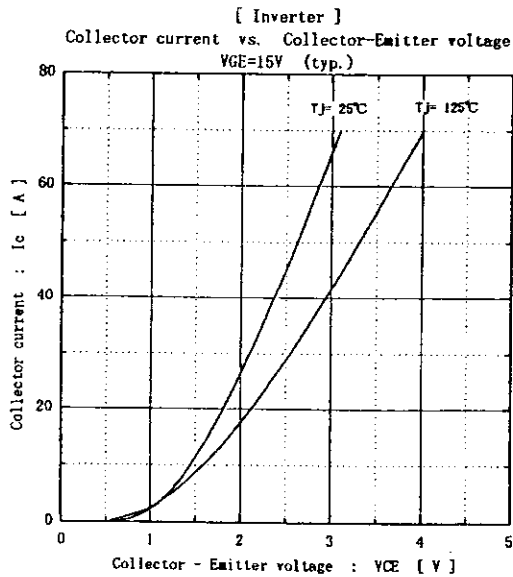
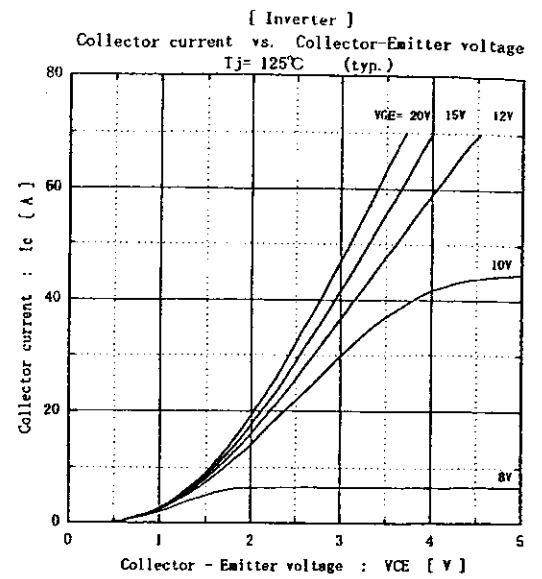
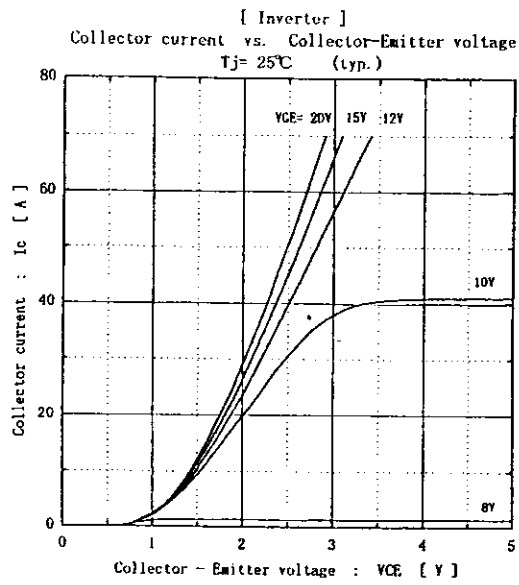

Fuji Electric Co., Ltd.

DWG. NO.

MS6M 0554

7 / 10

| |
|---|
| A |
| |
| |

This material and the information herein is the property of Fuji Electric Co., Ltd. They shall be neither reproduced, copied, lent, or disclosed in any way whatsoever for the use of any third party nor used for the manufacturing purposes without the express written consent of Fuji Electric Co., Ltd.

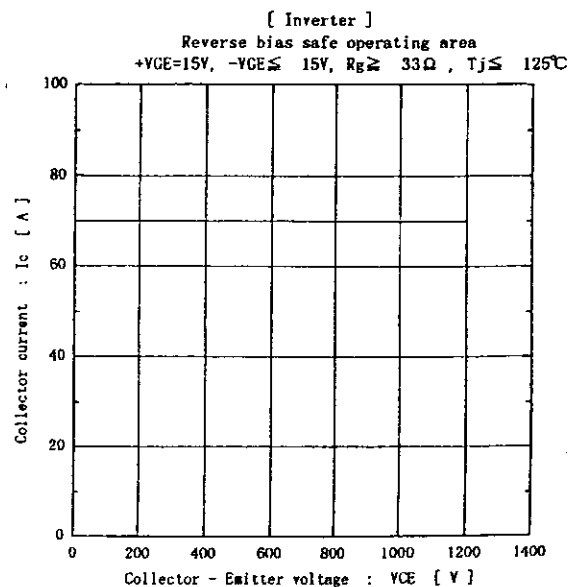
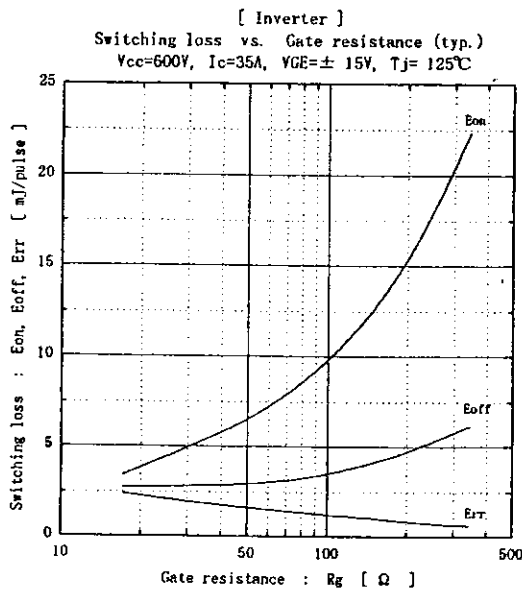
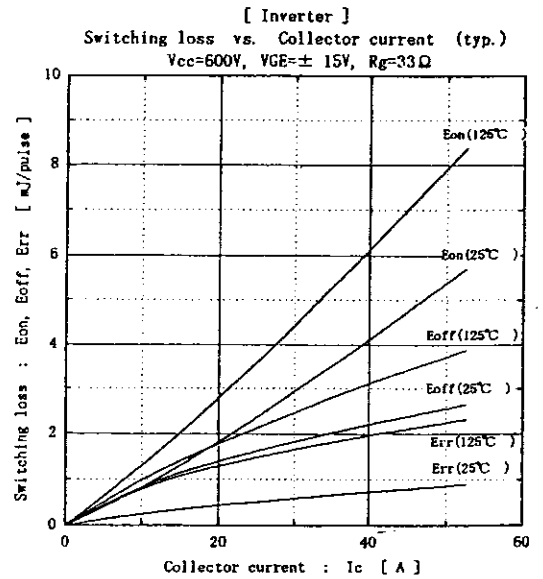
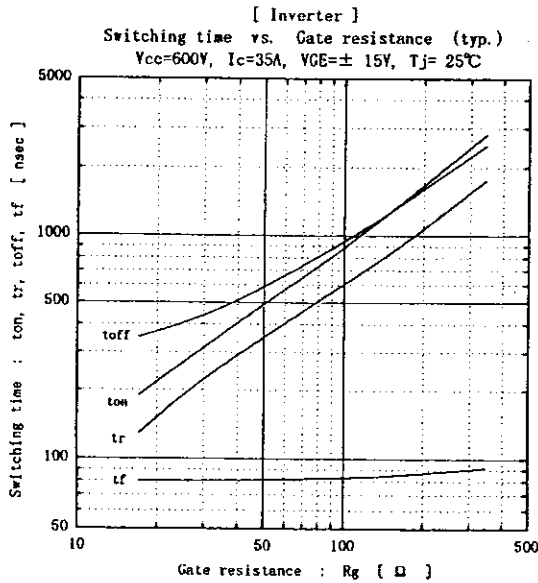
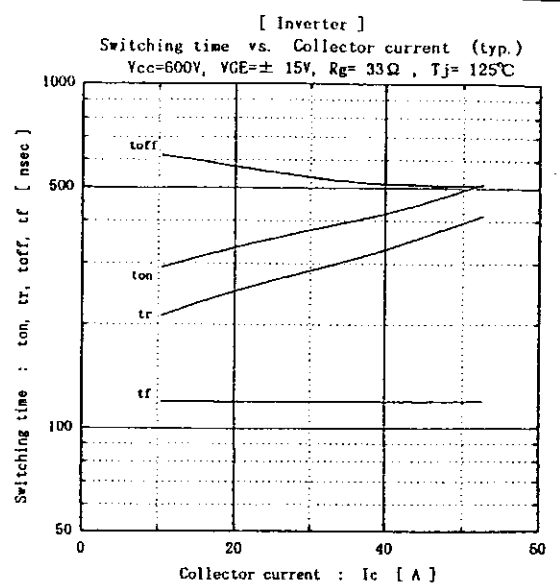
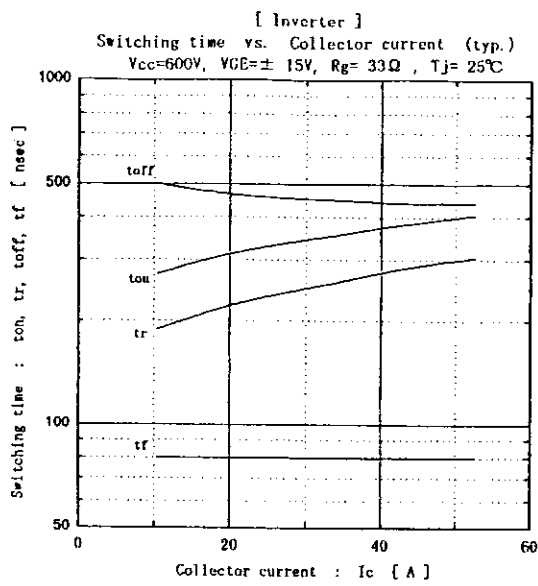

Fuji Electric Co., Ltd.

DWG. NO.

MS6M 0554

8 / 10

| |
|---|
| a |
| |
| |
| |

H04-004-03

This material and the information herein is the property of Fuji Electric Co. Ltd. They shall be neither reproduced, copied, lent, or disclosed in any way whatsoever for the use of any third party nor used for the manufacturing purposes without the express written consent of Fuji Electric Co. Ltd.

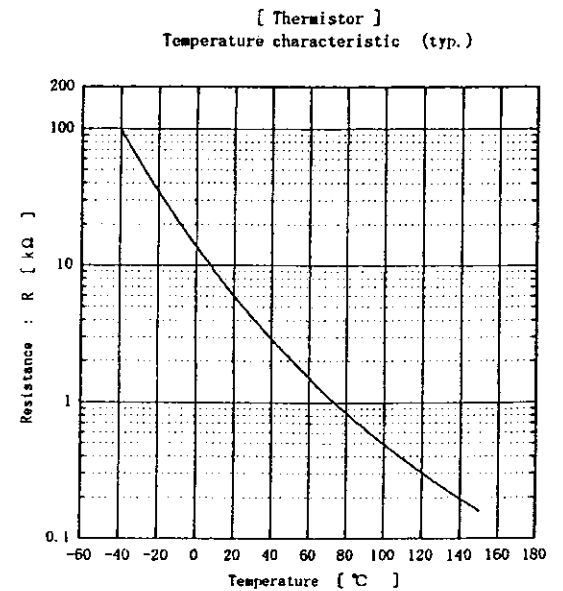
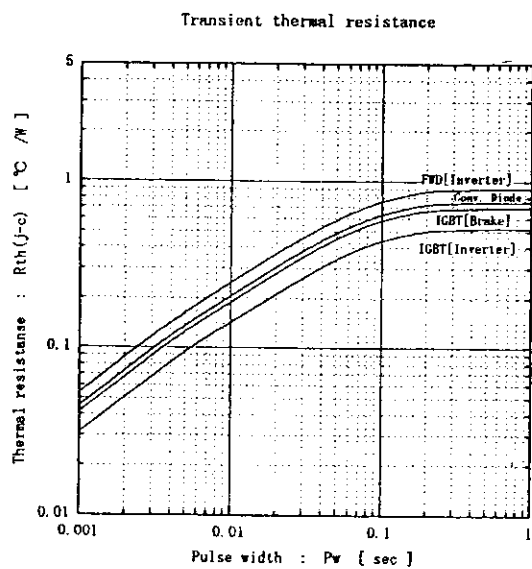
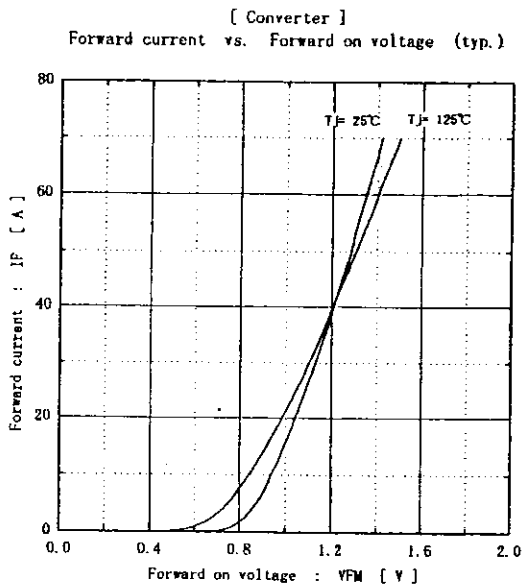
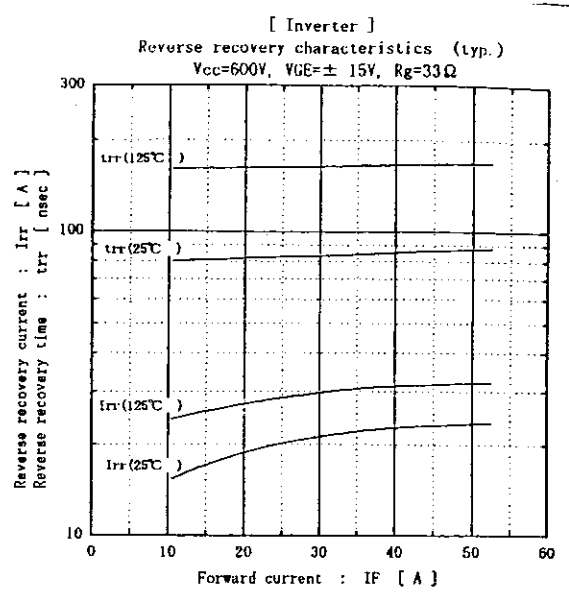
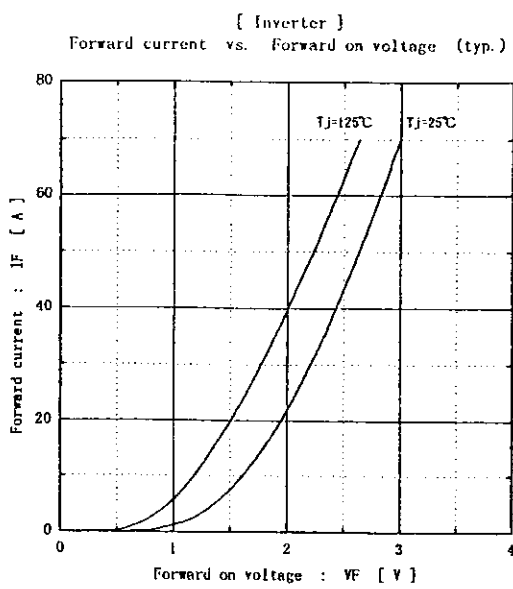

Fuji Electric Co., Ltd.

DWG. NO.

MS6M 0554

9 / 10

H04-004-03

This material and the information herein is the property of Fuji Electric Co., Ltd. They shall be neither reproduced, copied, lent, or disclosed in any way whatsoever for the use of any third party nor used for the manufacturing purposes without the express written consent of Fuji Electric Co., Ltd.

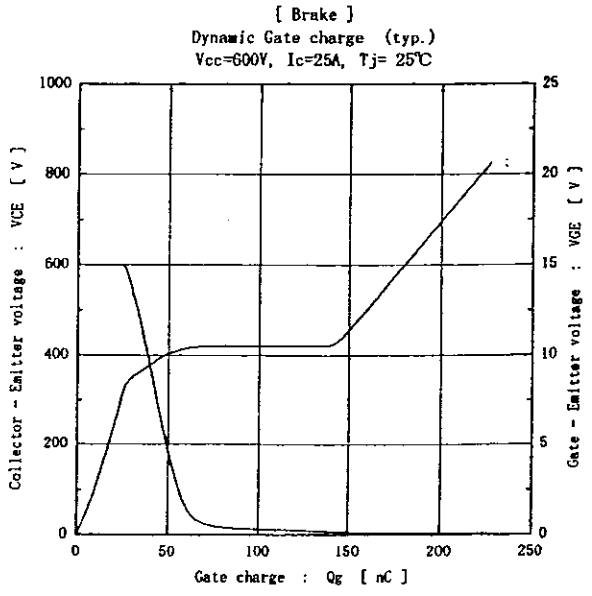
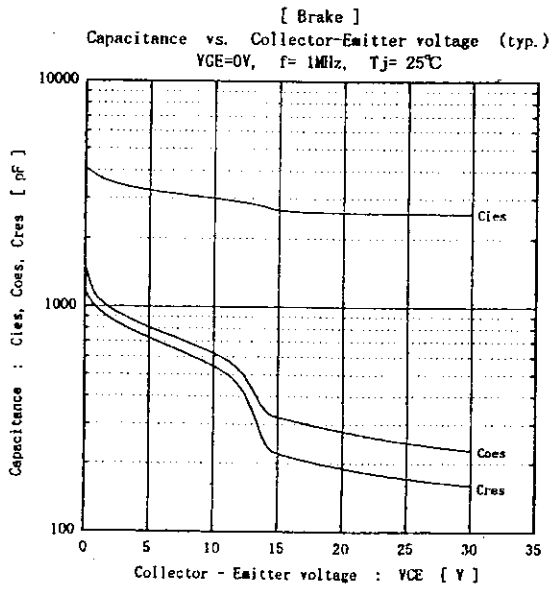
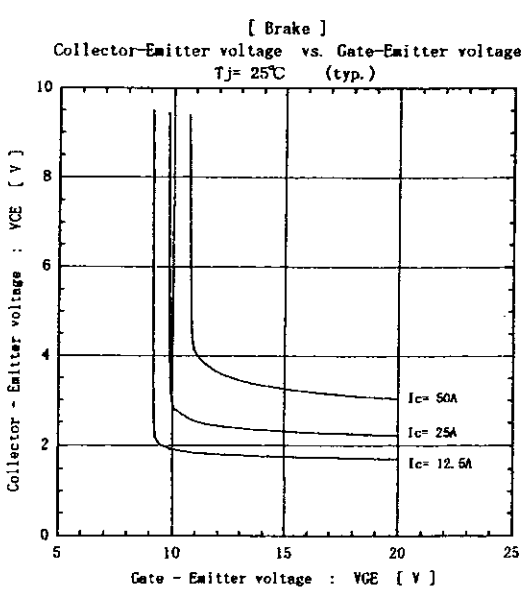
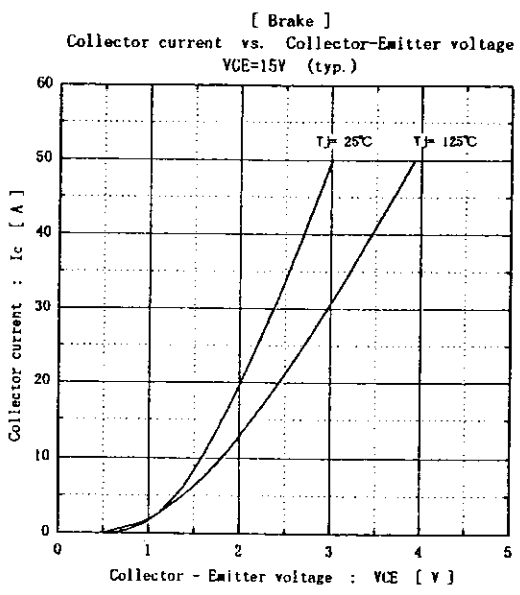
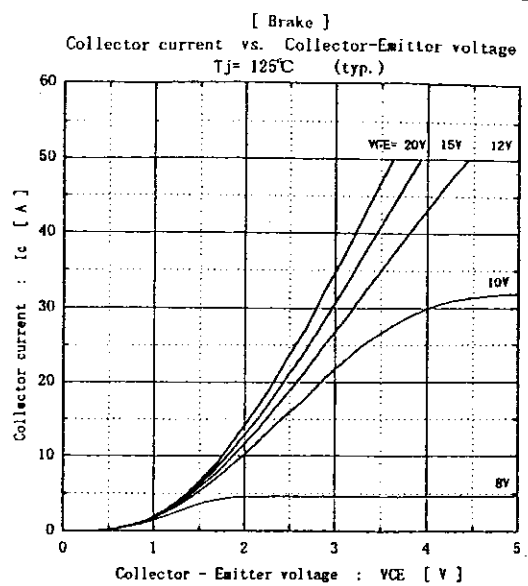
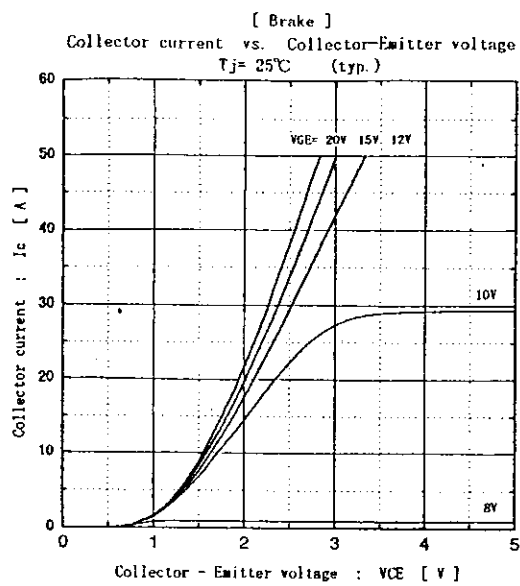

Fuji Electric Co., Ltd.

DWG. NO.

MS6M 0554

10 / 10

| |
|---|
| Q |
| |
| |

H04-004-03