

7MBP25RA120

IGBT-IPM R series

1200V / 25A 7 in one-package

Features

- Temperature protection provided by directly detecting the junction temperature of the IGBTs
- Low power loss and soft switching
- Compatible with existing IPM-N series packages
- High performance and high reliability IGBT with overheating protection
- Higher reliability because of a big decrease in number of parts in built-in control circuit

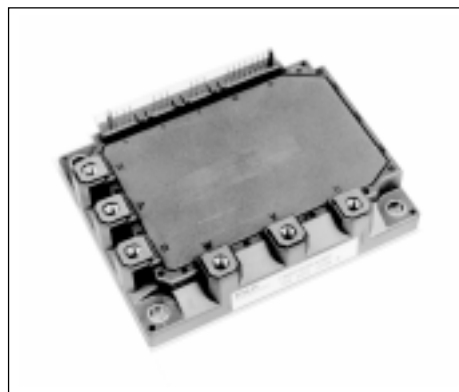

Maximum ratings and characteristics

- Absolute maximum ratings(at $T_c=25^\circ\text{C}$ unless otherwise specified)

Item	Symbol	Rating		Unit			
		Min.	Max.				
DC bus voltage	V_{DC}	0	900	V			
DC bus voltage (surge)	$V_{DC(surge)}$	0	1000	V			
DC bus voltage (short operating)	V_{SC}	200	800	V			
Collector-Emitter voltage	V_{CES}	0	1200	V			
DB Reverse voltage	V_R	-	1200	V			
INV	Collector current	DC	I_c	-	25	A	
		1ms	I_{CP}	-	50	A	
		DC	$-I_c$	-	25	A	
DB	Collector power dissipation	One transistor	P_C	-	198	W	
		Collector current	DC	I_c	-	15	A
			1ms	I_{CP}	-	30	A
Forward current of Diode			I_F	-	15	A	
Collector power dissipation		One transistor	P_C	-	120	W	
Junction temperature			T_j	-	150	$^\circ\text{C}$	
Input voltage of power supply for Pre-Driver			V_{CC}^{*1}	0	20	V	
Input signal voltage			V_{in}^{*2}	0	V_z	V	
Input signal current			I_{in}	-	1	mA	
Alarm signal voltage			V_{ALM}^{*3}	0	V_{CC}	V	
Alarm signal current			I_{ALM}^{*4}	-	15	mA	
Storage temperature			T_{stg}	-40	125	$^\circ\text{C}$	
Operating case temperature			T_{op}	-20	100	$^\circ\text{C}$	
Isolating voltage (Case-Terminal)			V_{iso}^{*5}	-	AC2.5	kV	
Screw torque	Mounting (M5)			-	3.5^{*6}	N·m	
	Terminal (M5)			-	3.5^{*6}	N·m	

*1 Apply V_{CC} between terminal No. 3 and 1, 6 and 4, 9 and 7, 11 and 10.

*2 Apply V_{in} between terminal No. 2 and 1, 5 and 4, 8 and 7, 12,13,14,15 and 10.

*3 Apply V_{ALM} between terminal No. 16 and 10.

*4 Apply I_{ALM} to terminal No. 16.

*5 50Hz/60Hz sine wave 1 minute.

*6 Recommendable Value : 2.5 to 3.0 N·m

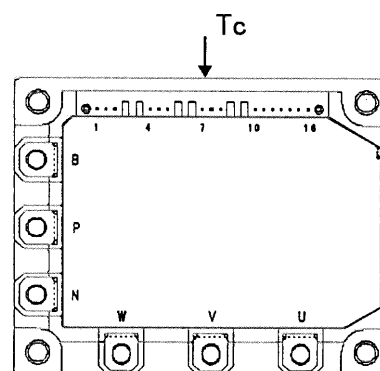

Fig.1 Measurement of case temperature

- Electrical characteristics of power circuit (at $T_c=T_j=25^\circ\text{C}$, $V_{CC}=15\text{V}$)

Item	Symbol	Condition	Min.	Typ.	Max.	Unit		
INV	Collector current at off signal input	I_{CES}	$V_{CE}=1200\text{V}$ input terminal open		-	-	1.0	mA
	Collector-Emitter saturation voltage	$V_{CE(sat)}$	$I_c=25\text{A}$		-	-	2.6	V
	Forward voltage of FWD	V_F	$-I_c=25\text{A}$		-	-	3.0	V
DB	Collector current at off signal input	I_{CES}	$V_{CE}=1200\text{V}$ input terminal open		-	-	1.0	mA
	Collector-Emitter saturation voltage	$V_{CE(sat)}$	$I_c=15\text{A}$		-	-	2.6	V
	Forward voltage of Diode	V_F	$-I_c=15\text{A}$		-	-	3.0	V

● Electrical characteristics of control circuit(at Tc=Tj=25°C, Vcc=15V)

Item	Symbol	Condition	Min.	Typ.	Max.	Unit	
Power supply current of P-line side Pre-driver(one unit)	I _{ccp}	fsw=0 to 15kHz Tc=-20 to 100°C *7	3	-	18	mA	
Power supply current of N-line side three Pre-driver	I _{ccn}	fsw=0 to 15kHz Tc=-20 to 100°C *7	10	-	65	mA	
Input signal threshold voltage (on/off)	V _{in(th)}	ON	1.00	1.35	1.70	V	
		OFF	1.25	1.60	1.95	V	
Input zener voltage	V _z	R _{in} =20k ohm	-	8.0	-	V	
Over heating protection temperature level	T _{COH}	VDC=0V, I _c =0A, Case temperature Fig.1	110	-	125	°C	
Hysteresis	T _{CH}		-	20	-	°C	
IGBT chips over heating protection temperature level	T _{JOH}	surface of IGBT chips	150	-	-	°C	
Hysteresis	T _{JH}		-	20	-	°C	
Collector current protection level	INV	I _{OC}	T _j =125°C	38	-	-	A
	DB	I _{OC}	T _j =125°C	23	-	-	A
Over current protection delay time	t _{DOC}	T _j =25°C Fig.2	-	10	-	μs	
Under voltage protection level	V _{UV}		11.0	-	12.5	V	
Hysteresis	V _H		0.2	-	-	V	
Alarm signal hold time	t _{ALM}		1.5	2	-	ms	
SC protection delay time	t _{SC}	T _j =25°C Fig.3	-	-	12	μs	
Limiting resistor for alarm	R _{ALM}		1425	1500	1575	ohm	

*7 Switching frequency of IPM

● Dynamic characteristics(at Tc=Tj=125°C, Vcc=15V)

Item	Symbol	Condition	Min.	Typ.	Max.	Unit
Switching time (IGBT)	t _{on}	I _C =25A, VDC=600V	0.3	-	-	μs
	t _{off}		-	-	3.6	μs
Switching time (FWD)	t _{rr}	I _F =25A, VDC=600V	-	-	0.4	μs

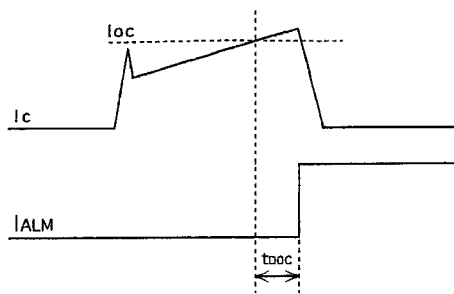

Fig.2 Definition of OC delay time

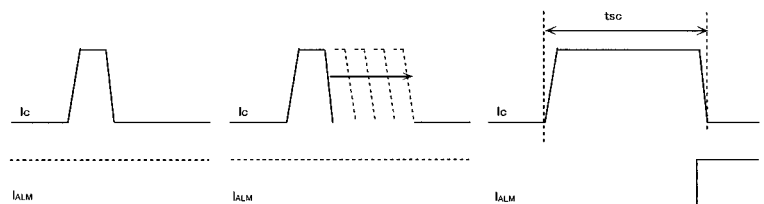

Fig.3 Definition of tsc

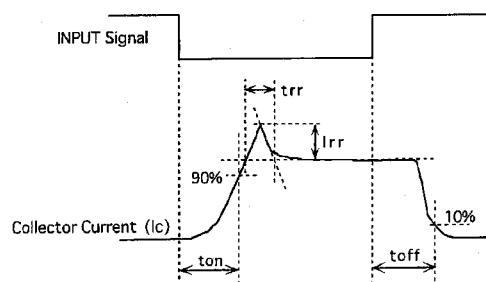

Fig.4 Definition of switching time

● Thermal characteristics(Tc=25°C)

Item	Symbol	Typ.	Max.	Unit		
Junction to Case thermal resistance	INV	IGBT	R _{th(j-c)}	-	0.63	°C/W
		FWD	R _{th(j-c)}	-	1.33	°C/W
	DB	IGBT	R _{th(j-c)}	-	1.04	°C/W
Case to fin thermal resistance with compound	R _{th(c-f)}	0.05	-	-	°C/W	

● Recommendable value

Item	Symbol	Min.	Typ.	Max.	Unit	
DC bus voltage	V _{DC}	200	-	800	V	
Operating power supply voltage range of Pre-driver	V _{CC}	13.5	15	16.5	V	
Switching frequency of IPM	fsw	1	-	20	kHz	
Screw torque	Mounting (M5)	-	2.5	-	3.0	N·m
	Terminal (M5)	-	2.5	-	3.0	N·m

Block diagram

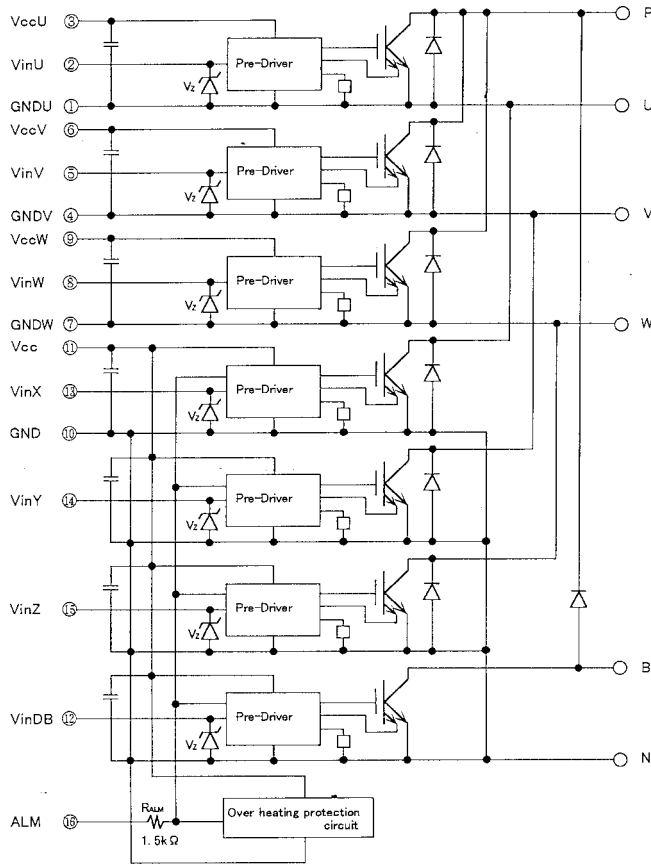

Pre-drivers include following functions

- a) Amplifier for driver
- b) Short circuit protection
- c) Undervoltage lockout circuit
- d) Over current protection
- e) IGBT chip over heating protection

Outline drawings, mm

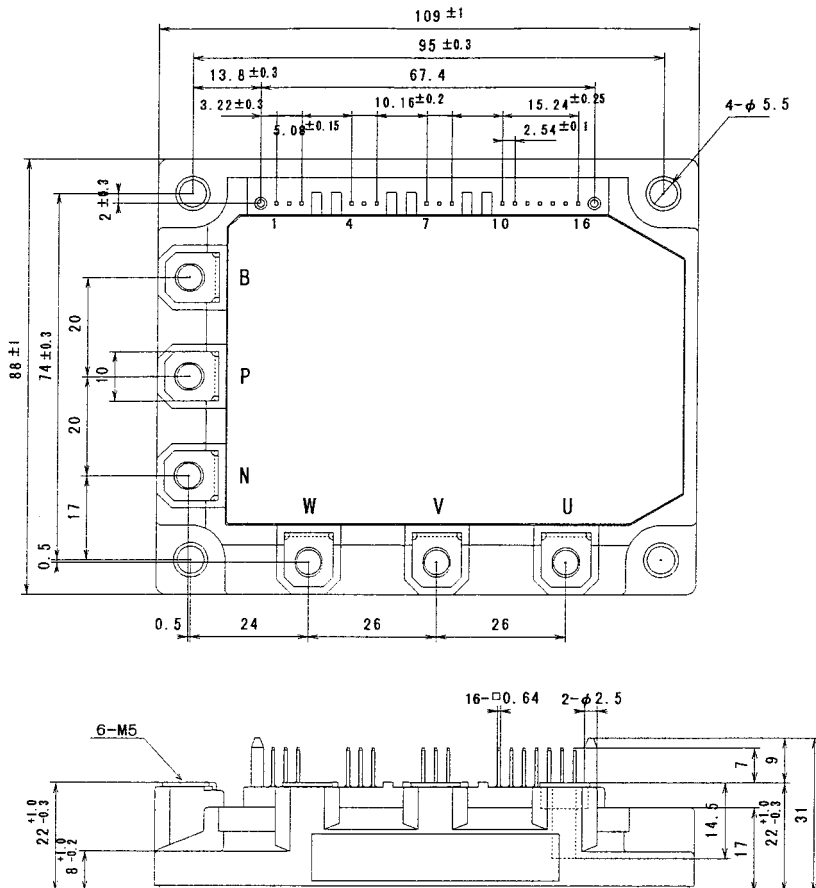

Mass : 440g

Characteristics (Representative)

Control Circuit

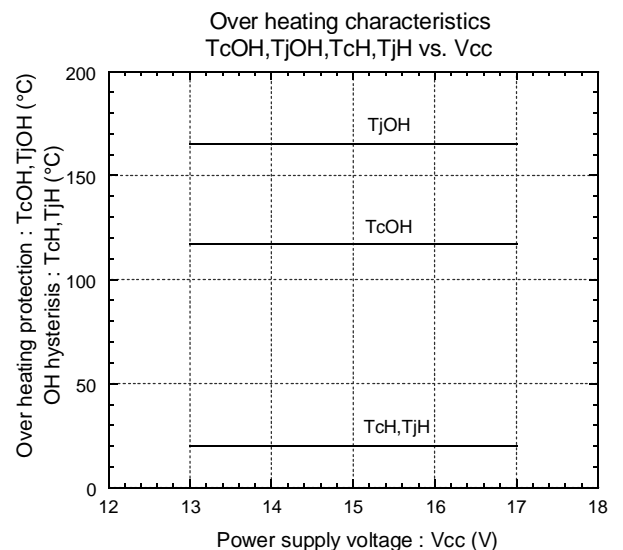
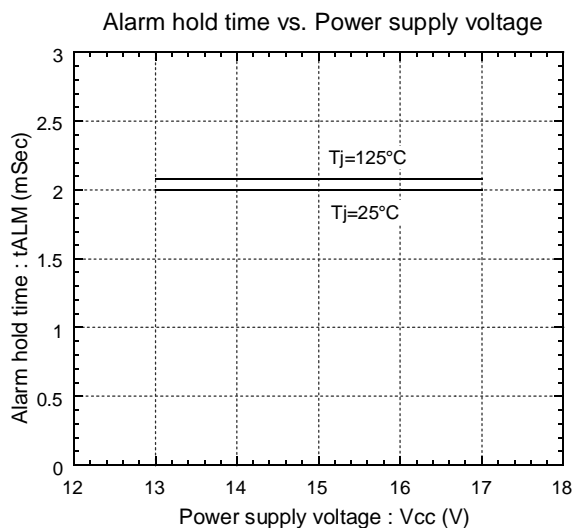
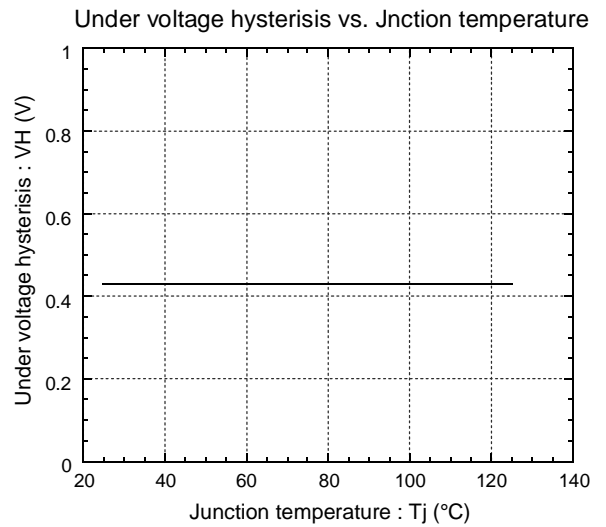
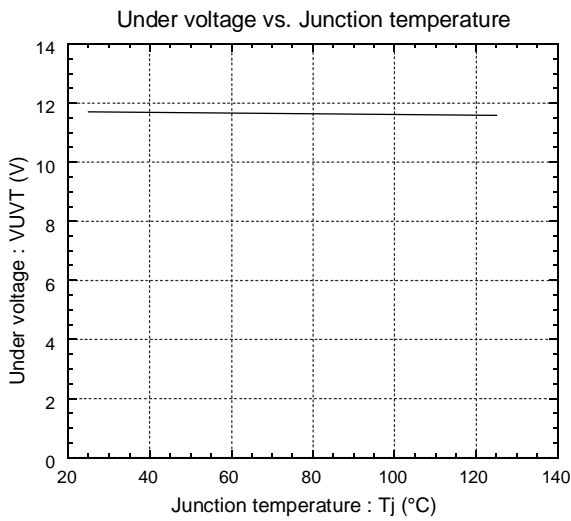
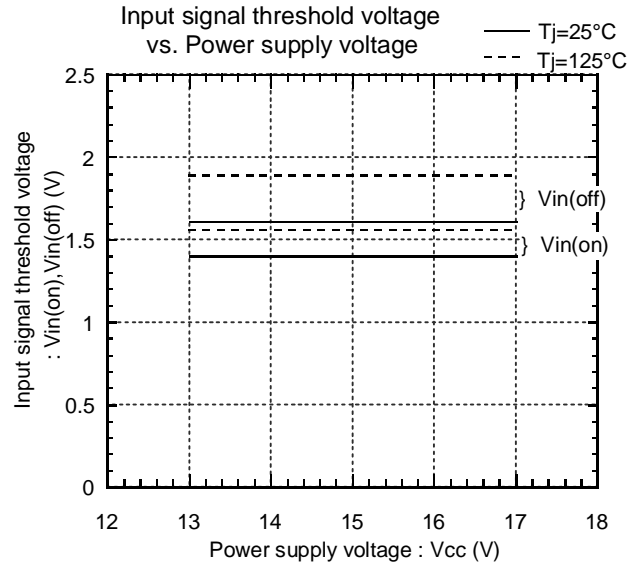
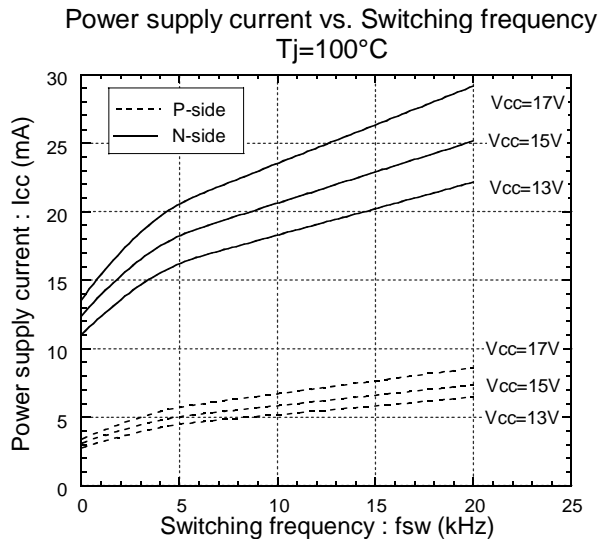

● Inverter

Collector current vs. Collector-Emitter voltage
T_j=25°C

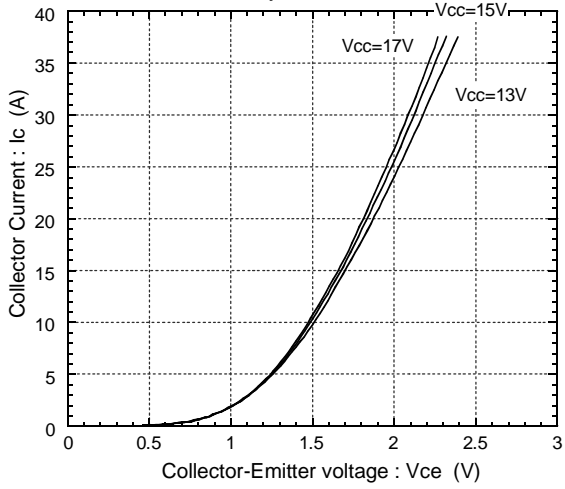

Collector current vs. Collector-Emitter voltage
T_j=125°C

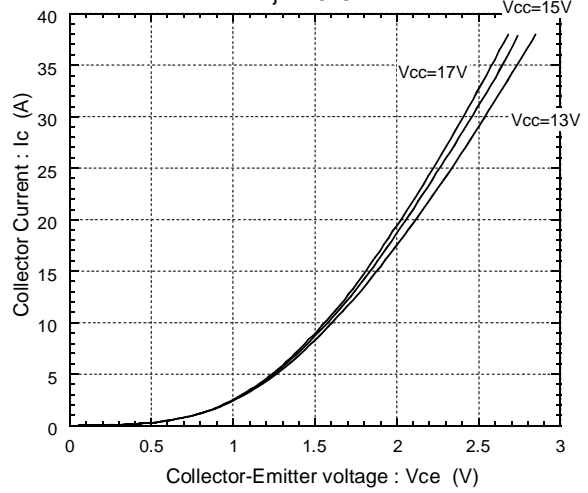

Switching time vs. Collector current
E_{dc}=600V, V_{cc}=15V, T_j=25°C

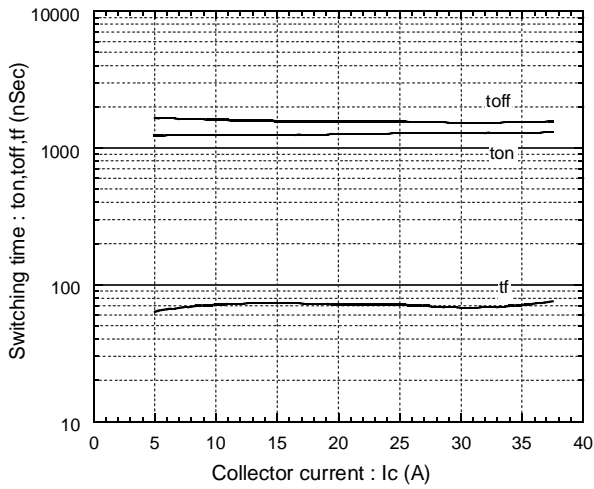

Switching time vs. Collector current
E_{dc}=600V, V_{cc}=15V, T_j=125°C

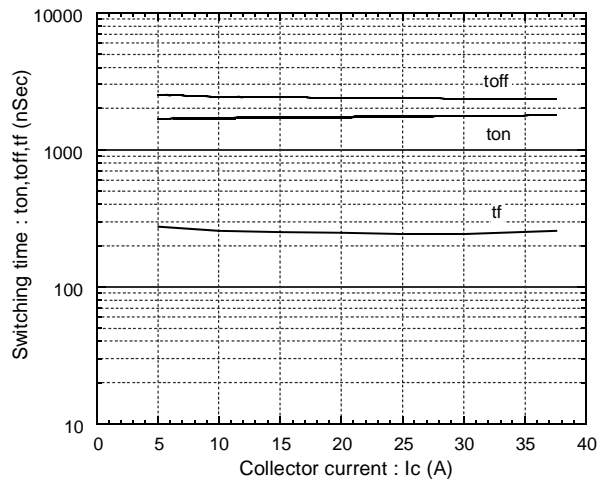

Forward current vs. Forward voltage

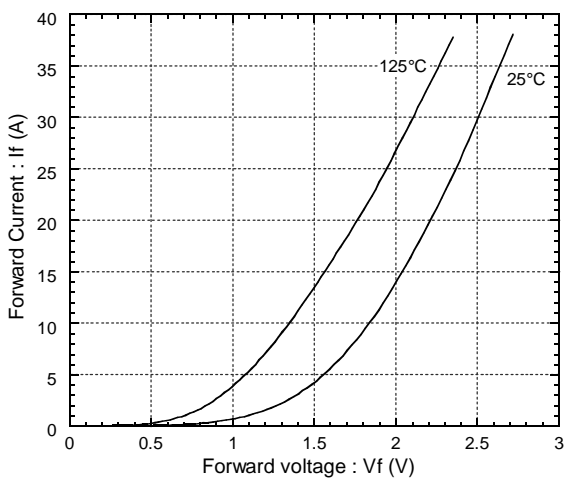

Reverse recovery characteristics
trr, Irr vs. IF

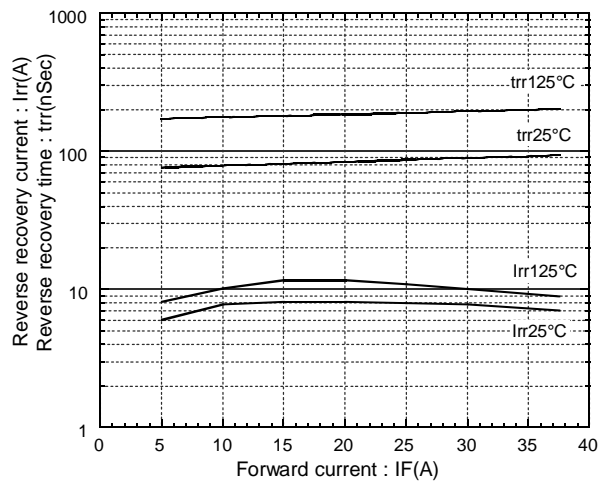

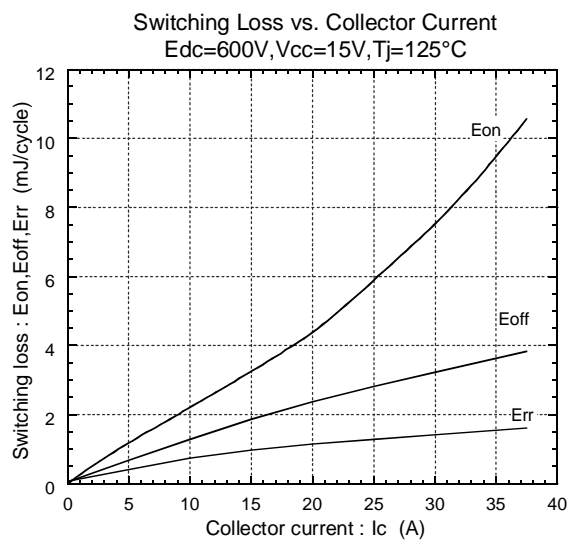
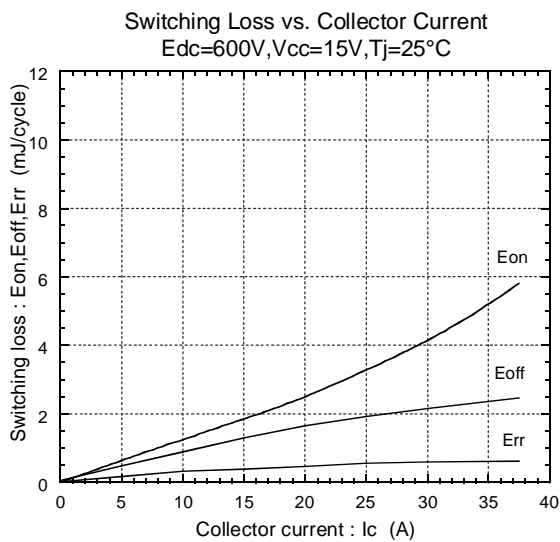
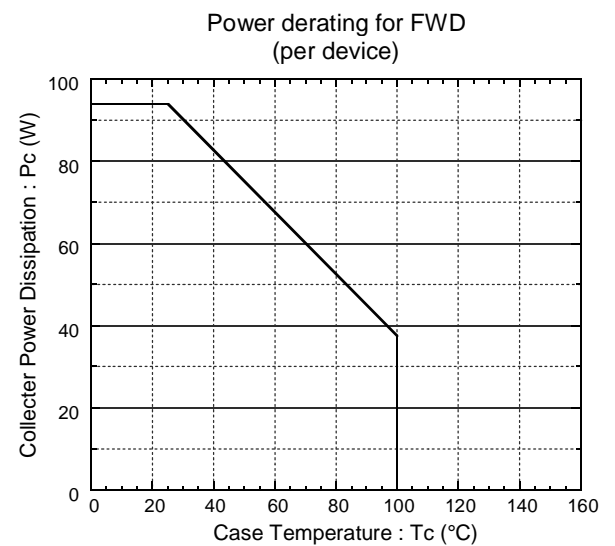
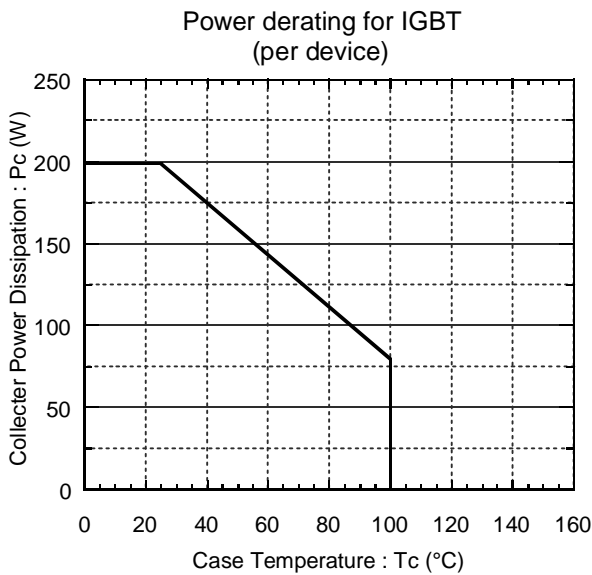
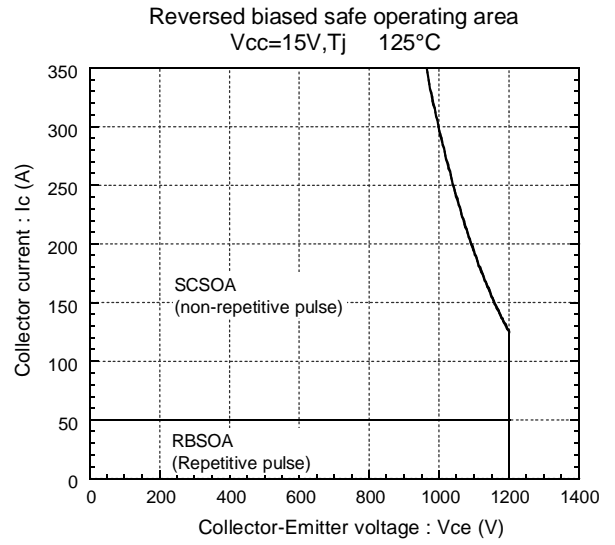
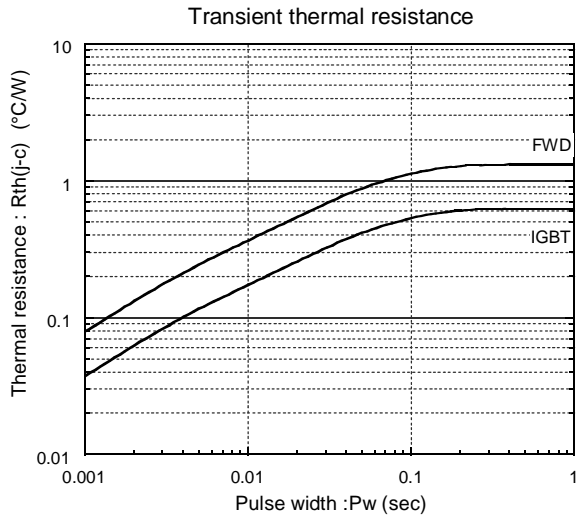

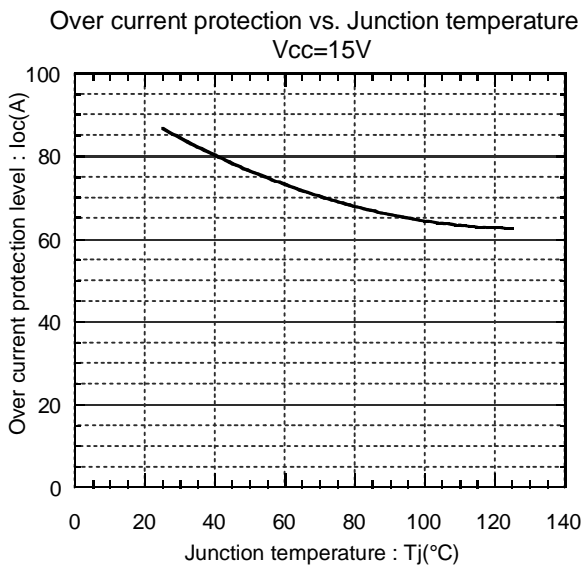

● Brake

Collector current vs. Collector-Emmitter voltage
Tj=25°C

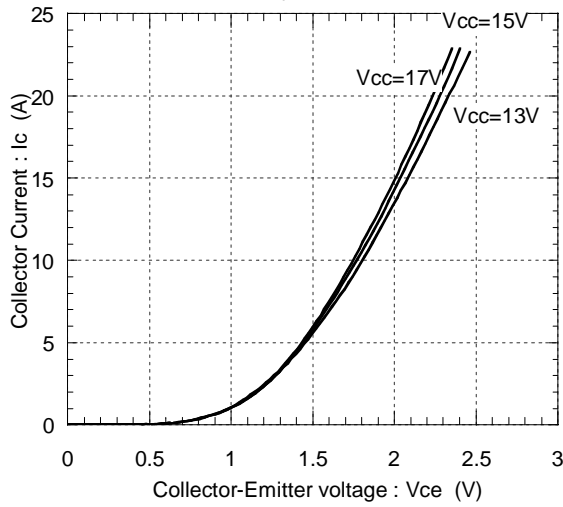

Collector current vs. Collector-Emmitter voltage
Tj=125°C

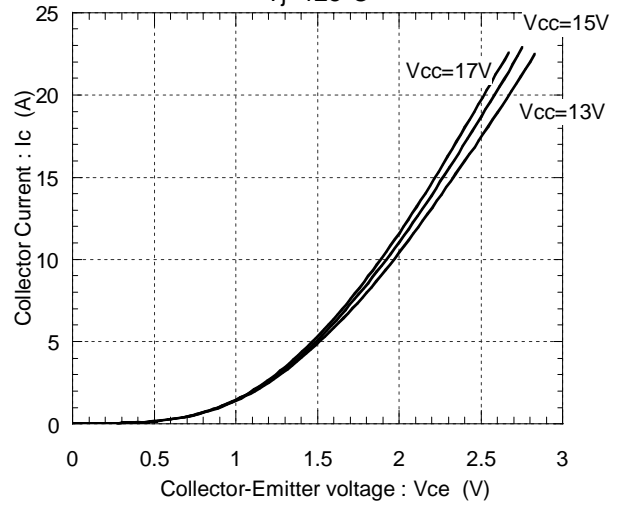

Transient thermal resistance

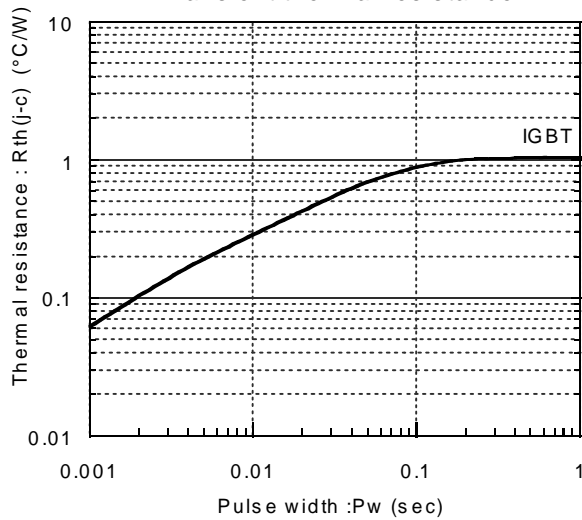

Reversed biased safe operating area
Vcc=15V, Tj ≤ 125°C

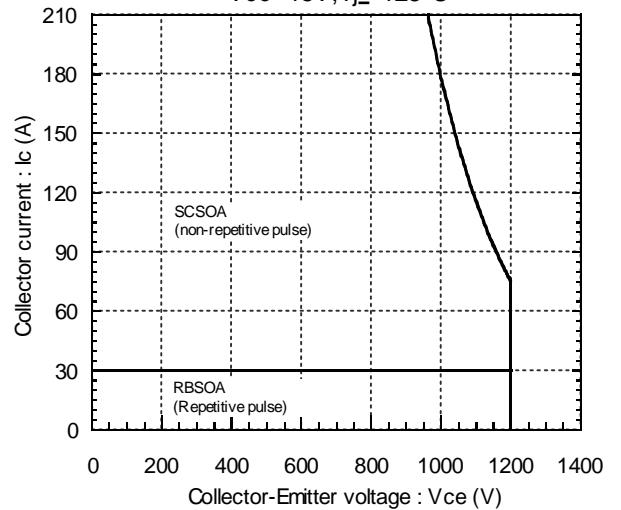

Power derating for IGBT
(per device)

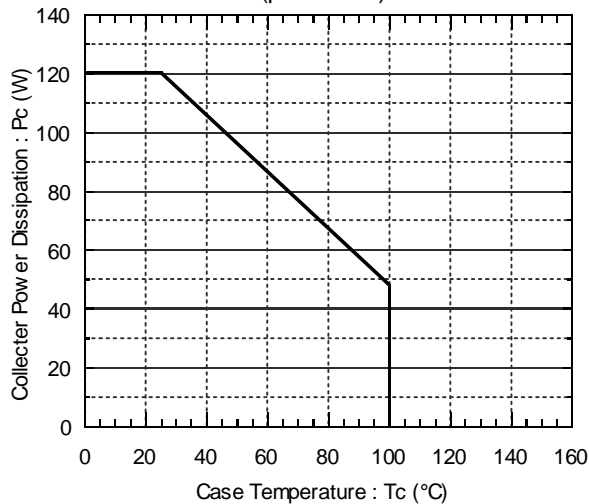

Over current protection vs. Junction temperature
Vcc=15V

