

## Intelligent Power Module ( R-Series )

### Maximum Ratings and Characteristics

#### Absolute Maximum Ratings ( $T_c=25^\circ\text{C}$ )

Items	Symbols	Ratings		Units
		Min.	Max.	
DC Bus Voltage	$V_{DC}$	0	450	V
DC Bus Voltage (surge)	$V_{DC(\text{Surge})}$	0	500	
DC Bus Voltage (short operating)	$V_{SC}$	200	400	
Collector-Emitter Voltage	$V_{CES}$	0	600	
Inverter Collector Current	Continuous	$I_C$	150	A
	1ms	$I_{CP}$	300	
	Duty=58.8%	$-I_C$	150	
Collector Power Dissipation (One Transistor)	$P_C$		595	W
Voltage of Power Supply for Driver	$V_{CC}^*1$	0	20	V
Input Signal Voltage	$V_{IN}^*2$	0	$V_Z$	V
Input Signal Current	$I_{IN}$		1	mA
Alarm Signal Voltage	$V_{ALM}^*3$	0	$V_{CC}$	V
Alarm Signal Current	$I_{ALM}^*4$		15	mA
Junction Temperature	$T_J$		150	$^\circ\text{C}$
Operating Temperature	$T_{OP}$	-20	100	
Storage Temperature	$T_{stg}$	-40	125	
Isolation Voltage	A.C. 1min. $V_{iso}$		2500	
Screw Torque	Mounting $^*1$		3.5	Nm
	Terminals $^*1$		3.5	

Note:  $^*1$ : Recommendable Value; 2.5 – 3.0 Nm (M5)

### Outline Drawing

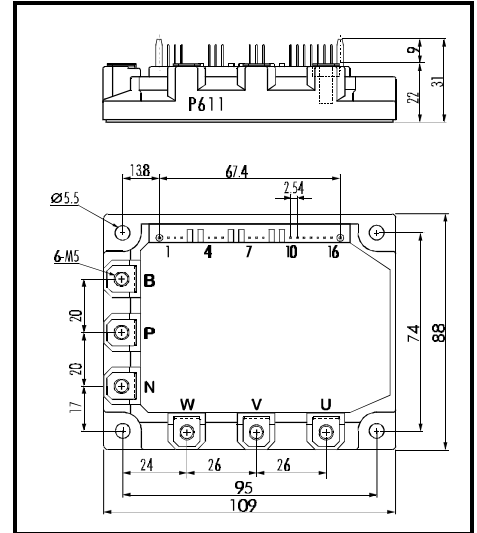

Fig. 1

#### Electrical Characteristics of Power Circuit ( at $T_J=25^\circ\text{C}$ , $V_{CC}=15\text{V}$ )

Items	Symbols	Conditions	Min.	Typ.	Max.	Units
INV	Collector Current At Off Signal Input	$I_{CES}$	$V_{CE}=600\text{V}$ , Input Terminal Open		1.0	mA
	Collector-Emitter Saturation Voltage	$V_{CE(\text{Sat})}$	$I_C=150\text{A}$		2.8	V
	Forward Voltage of FWD	$V_F$	$-I_C=150\text{A}$		3.0	V

#### Electrical Characteristics of Control Circuit ( at $T_J=25^\circ\text{C}$ , $V_{CC}=15\text{V}$ )

Items	Symbols	Conditions	Min.	Typ.	Max.	Units
Current of P-Line Side Driver (One Unit)	$I_{CCP}$	$f_{SW}=0\sim 15\text{kHz}$ , $T_C=-20\sim 100^\circ\text{C}$	3		18	mA
Current of N-Line Side Driver (Three Units)	$I_{CCN}$	$f_{SW}=0\sim 15\text{kHz}$ , $T_C=-20\sim 100^\circ\text{C}$	10		65	
Input Signal Threshold Voltage	$V_{IN(\text{th})}$	On	1.00	1.35	1.70	V
		Off	1.25	1.60	1.95	
Input Zener Voltage	$V_Z$	$R_{IN}=20\text{k}\Omega$		8.0		
Over Heating Protection Temperature Level	$T_{COH}$	$V_{DC}=0\text{V}$ , $I_C=0\text{A}$ , Case Temp.	110		125	$^\circ\text{C}$
Hysteresis	$T_{CH}$			20		
IGBT Chips Over Heating Protec. Temp. Level	$T_{IOH}$	Surface of IGBT Chip	150			
Hysteresis	$T_{IH}$			20		
Inverter Collector Current Protection Level	$I_{OC}$	$T_J=125^\circ\text{C}$	225			A
Over Current Detecting Time	$t_{DOC}$	$T_J=25^\circ\text{C}$		10		$\mu\text{s}$
Alarm Signal Hold Time	$t_{ALM}$		1.5	2		ms
Limiting Resistor for Alarm	$R_{ALM}$		1425	1500	1575	$\Omega$
Under Voltage Protection Level	$V_{UV}$		11.0		12.5	V
Hysteresis	$V_H$		0.2			

#### Dynamic Characteristics ( at $T_C=T_J=125^\circ\text{C}$ , $V_{CC}=15\text{V}$ )

Items	Symbols	Conditions	Min.	Typ.	Max.	Units
Switching Time	$t_{ON}$	$I_C=150\text{A}$ , $V_{DC}=300\text{V}$	0.3			$\mu\text{s}$
	$t_{OFF}$				3.6	
	$t_{RR}$	$I_F=150\text{A}$ , $V_{DC}=300\text{V}$			0.4	

#### Thermal Characteristics

Items	Symbols	Conditions	Min.	Typ.	Max.	Units
Thermal Resistance	$R_{th(i-c)}$	Inverter IGBT			0.21	$^\circ\text{C}/\text{W}$
	$R_{th(i-c)}$	Diode			0.47	
	$R_{th(c-f)}$	With Thermal Compound		0.05		

## ■ Equivalent Circuit

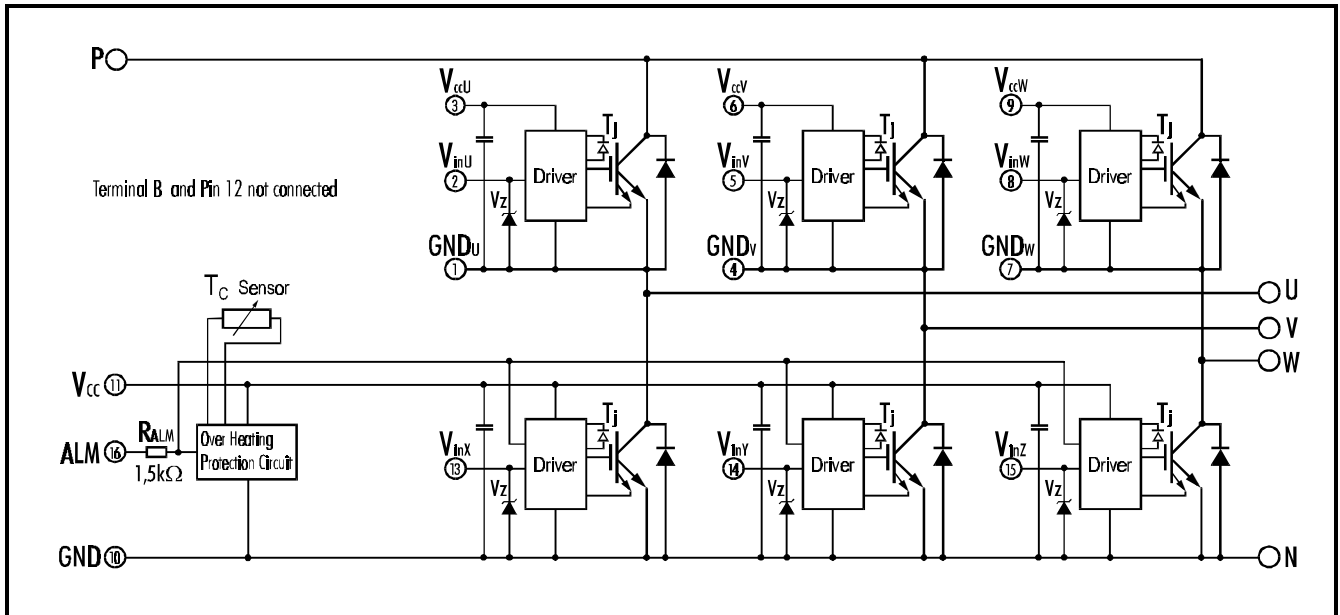

Drivers include following functions

- Short circuit protection circuit
- Amplifier for driver
- Undervoltage protection circuit
- Overcurrent protection circuit
- IGBT Chip overheating protection

## Control Circuit

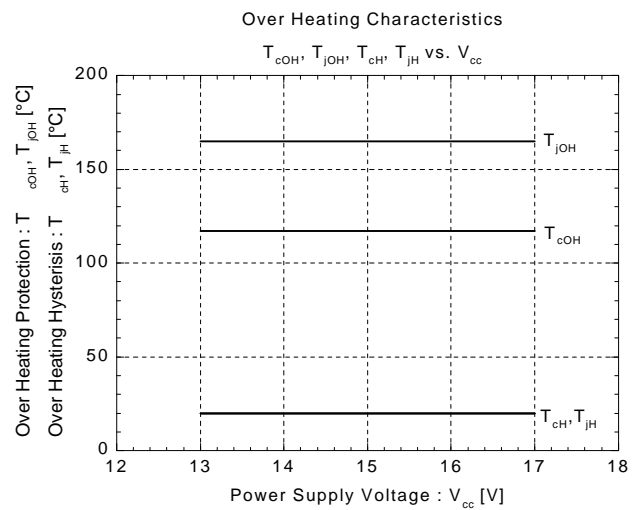
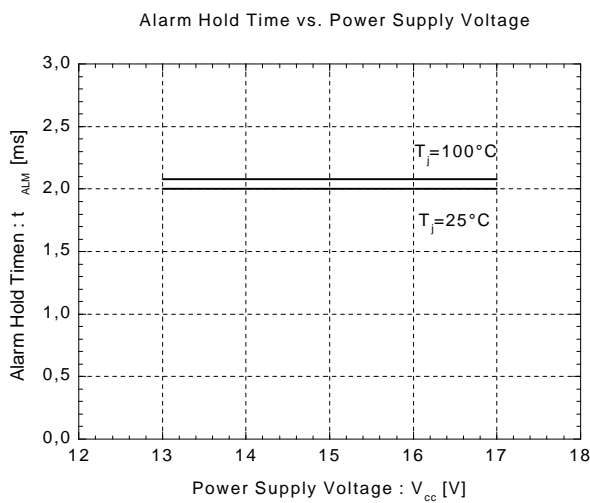
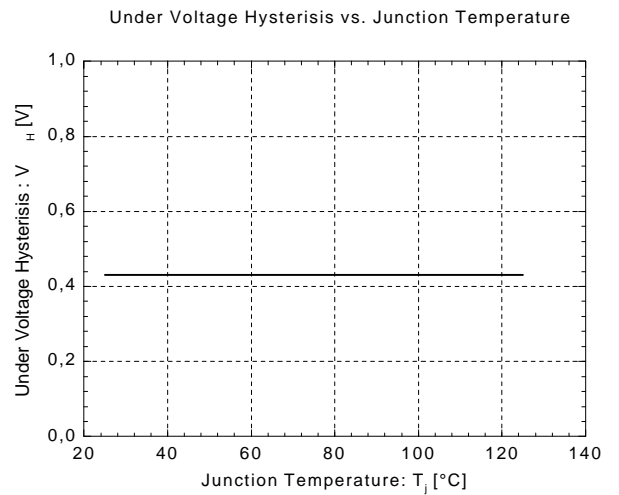
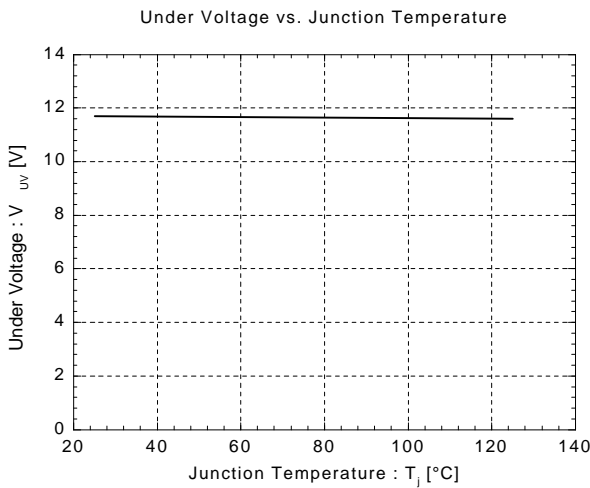
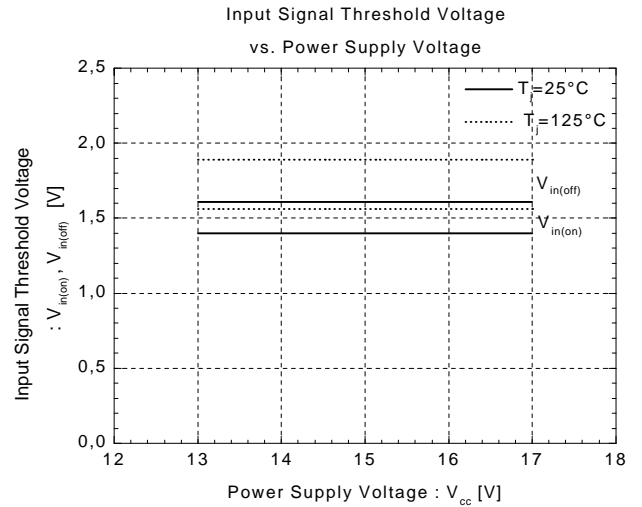
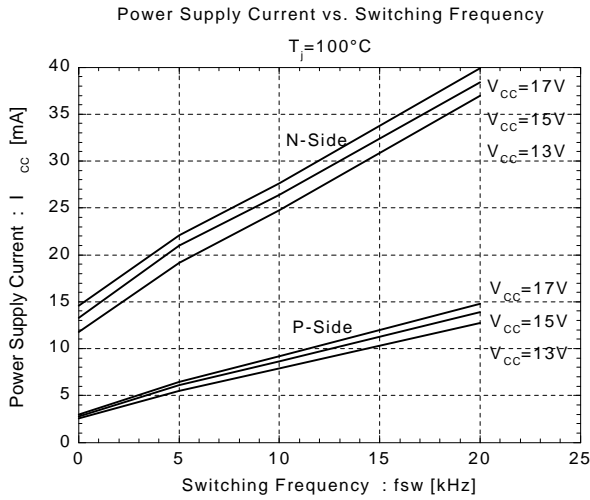

■ Inverter

Collector Current vs. Collector-Emitter Voltage

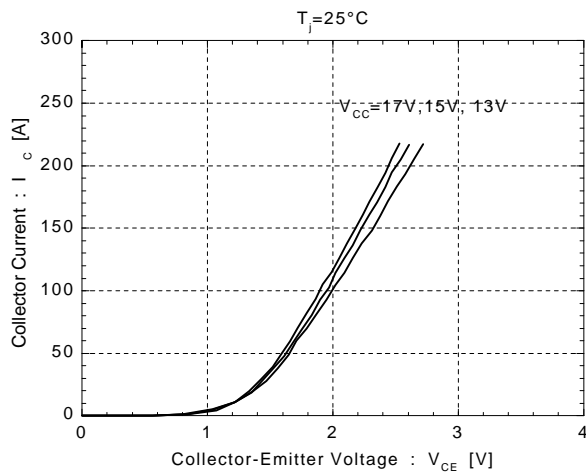

Collector Current vs. Collector-Emitter Voltage

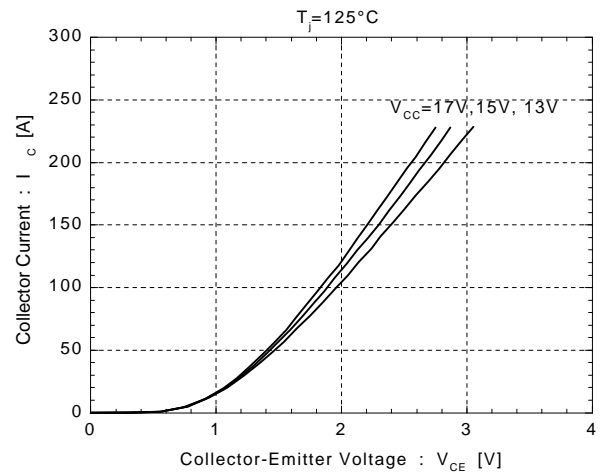

Switching Time vs. Collector Current

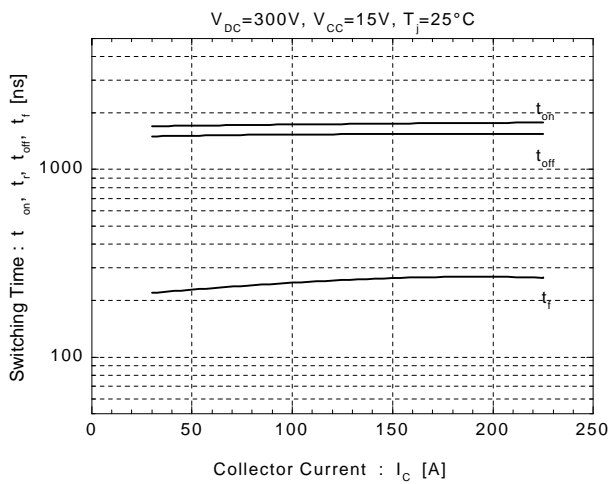

Switching Time vs. Collector Current

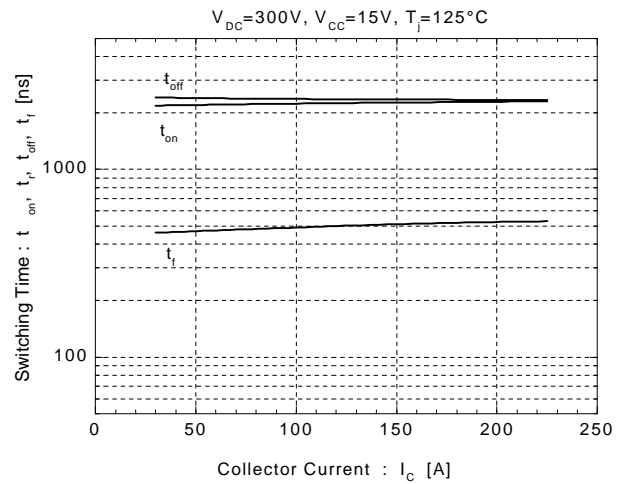

Forward Voltage vs. Forward Current

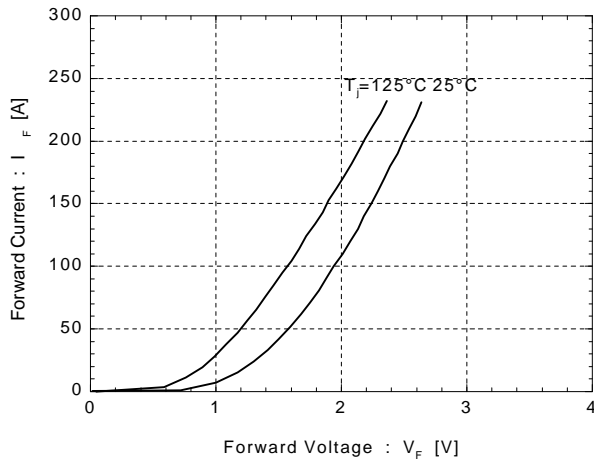

Reverse Recovery Characteristics

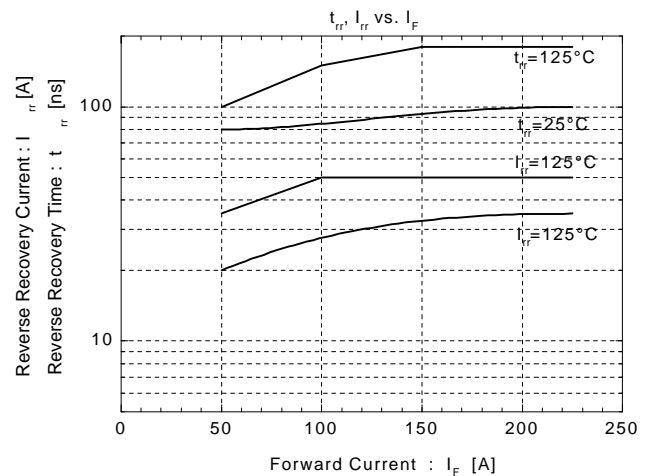

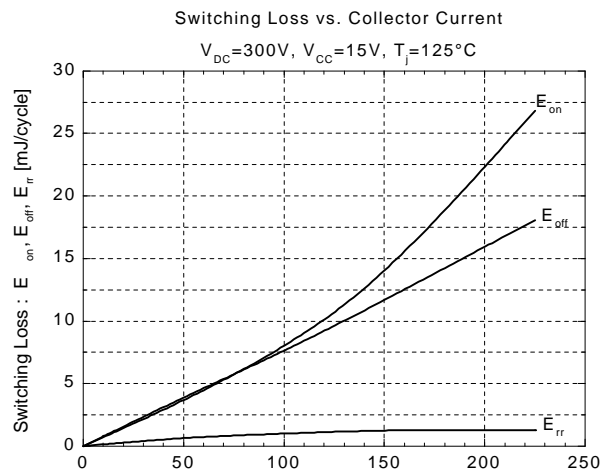
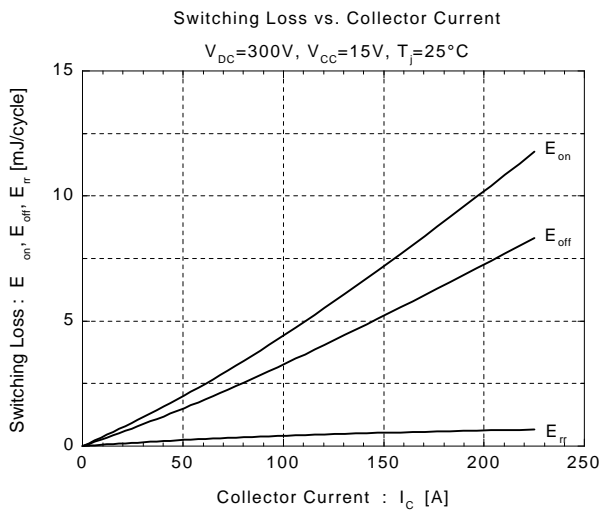
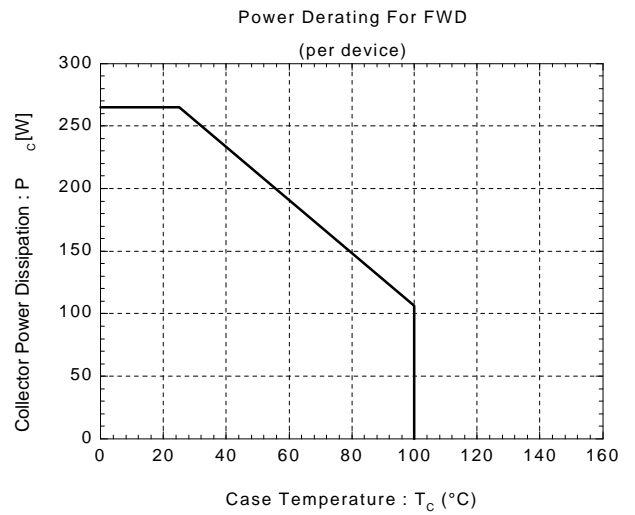
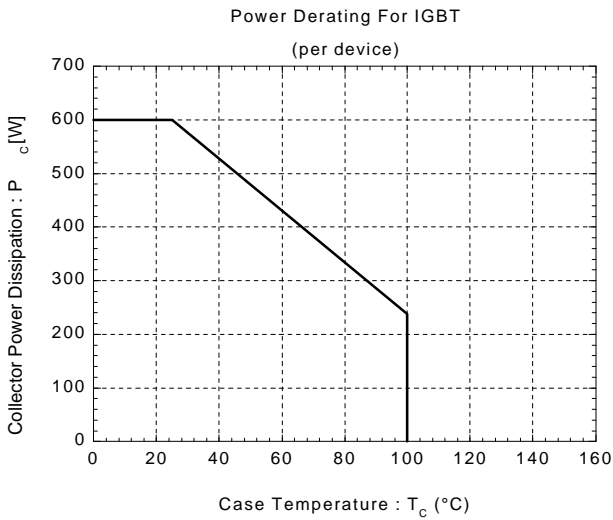
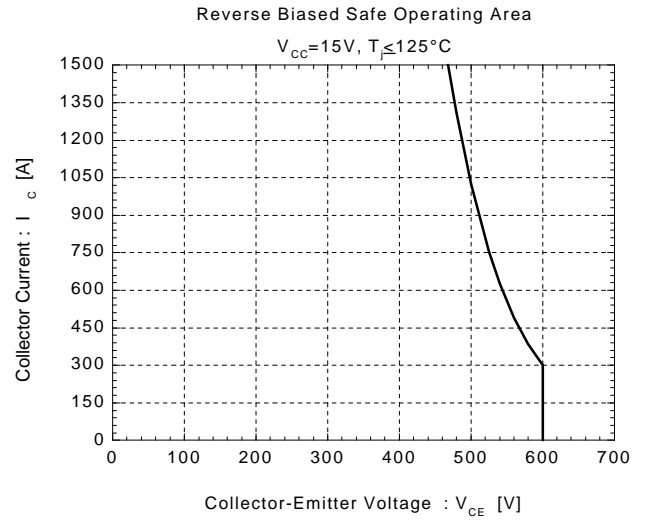
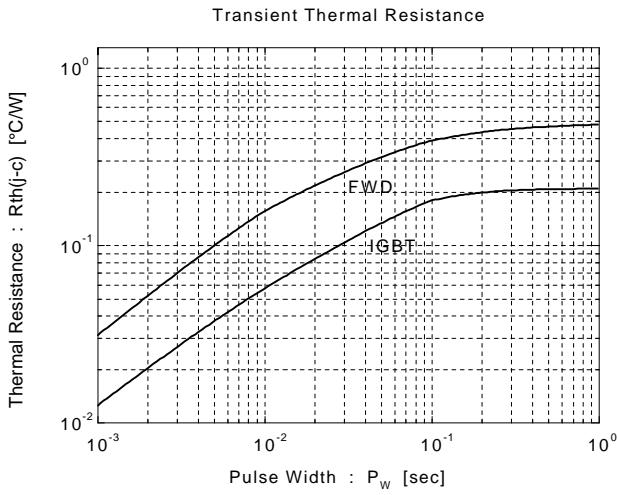

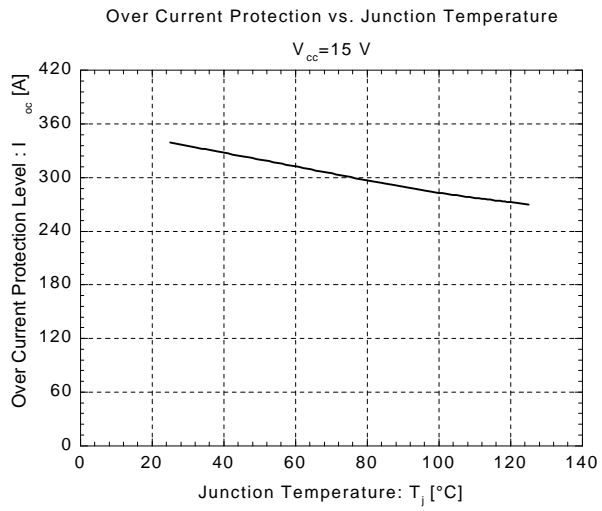

■ Outline Drawing

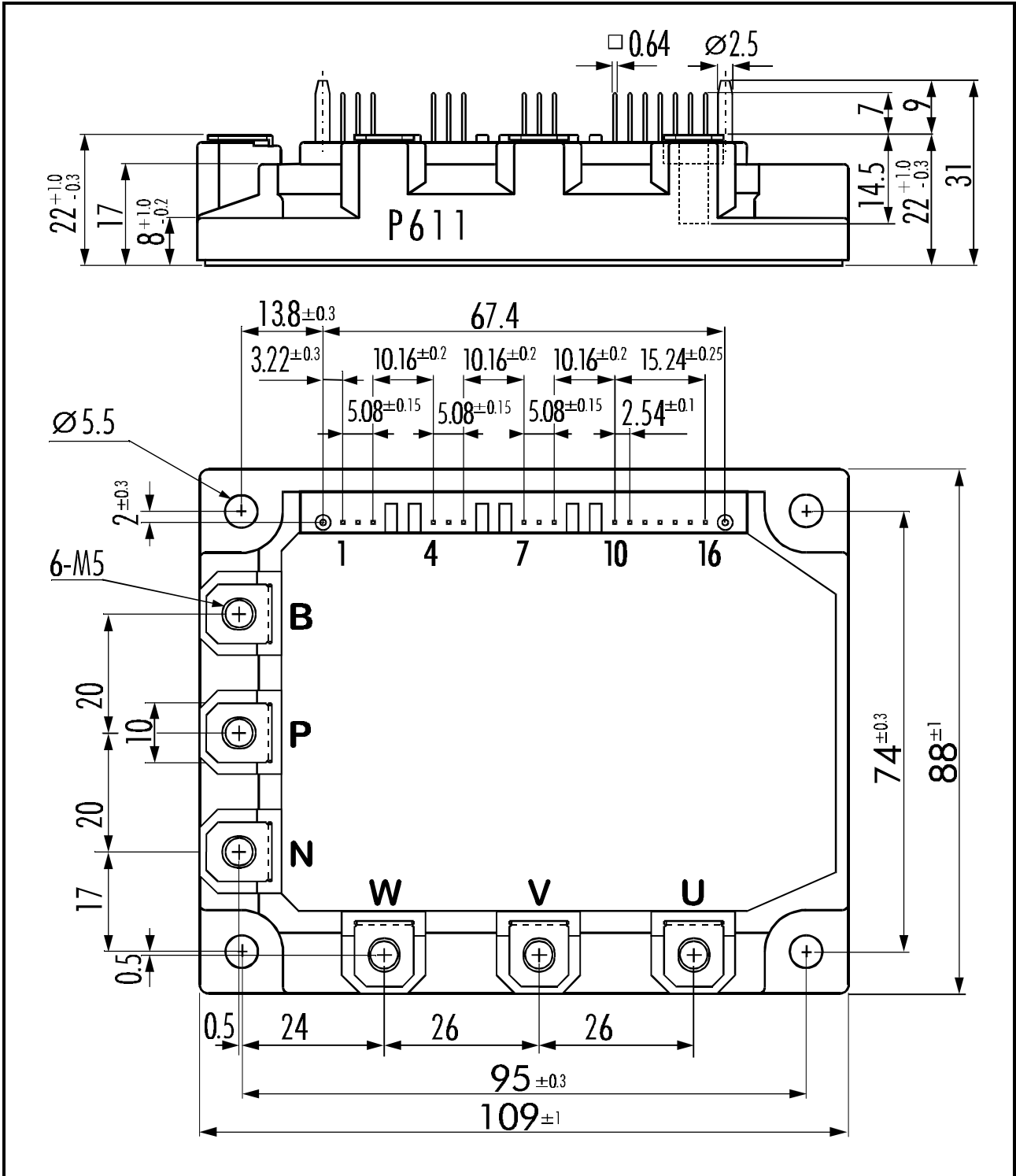

**Weight: 440g**