

TS906C2 (20A)

(200V / 20A)

LOW LOSS SUPER HIGH SPEED RECTIFIER

Features

- Surface-mount device
- Low V_F
- Super high speed switching
- High reliability by planer design

Applications

- High speed power switching

Maximum ratings and characteristics

- Absolute maximum ratings

| Item | Symbol | Conditions | Rating | Unit |
|---------------------------------|-----------|--|-------------|------------------|
| Repetitive peak reverse voltage | V_{RRM} | | 200 | V |
| Average output current | I_O | Square wave, duty=1/2, $T_c=112^\circ\text{C}$ | 20* | A |
| Surge current | I_{FSM} | Sine wave 10ms | 80 | A |
| Operating junction temperature | T_j | | -40 to +150 | $^\circ\text{C}$ |
| Storage temperature | T_{stg} | | -40 to +150 | $^\circ\text{C}$ |

*Average forward current of centertap full wave connection

- Electrical characteristics ($T_a=25^\circ\text{C}$ Unless otherwise specified)

| Item | Symbol | Conditions | Max. | Unit |
|-----------------------|---------------|--|------|--------------------|
| Forward voltage drop | V_{FM} | $I_{FM}=10\text{A}$ | 0.98 | V |
| Reverse current | I_{RRM} | $V_R=V_{RRM}$ | 200 | μA |
| Reverse recovery time | t_{rr} | $I_F=0.1\text{A}$, $I_R=0.2\text{A}$, $I_{rec}=0.05\text{A}$ | 35 | ns |
| Thermal resistance | $R_{th(j-c)}$ | Junction to case | 2.0* | $^\circ\text{C/W}$ |

Outline drawings, mm

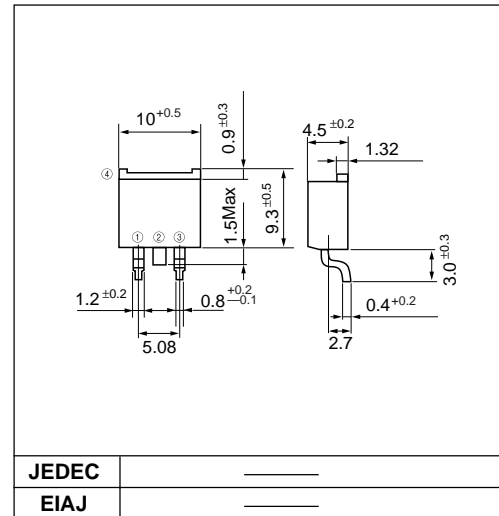

Connection diagram

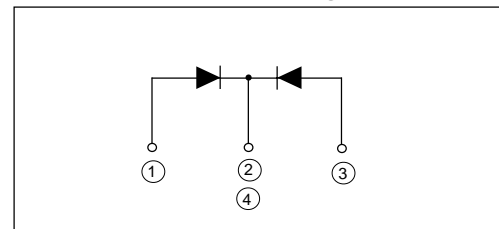

Characteristics

Forward characteristics

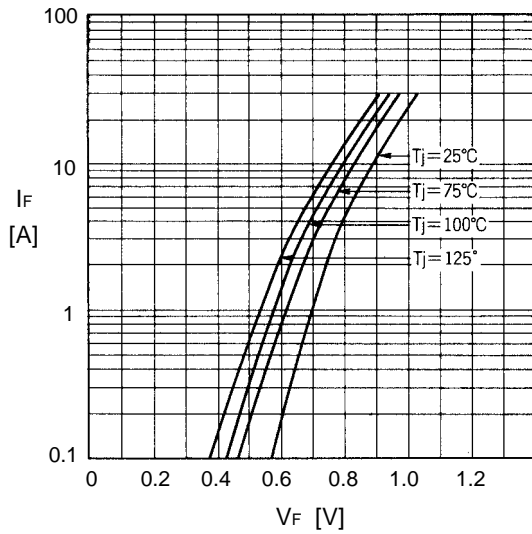

Reverse characteristics

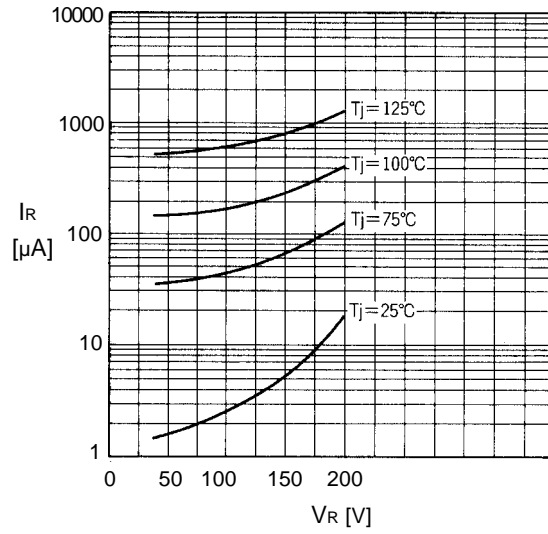

Forward power dissipation

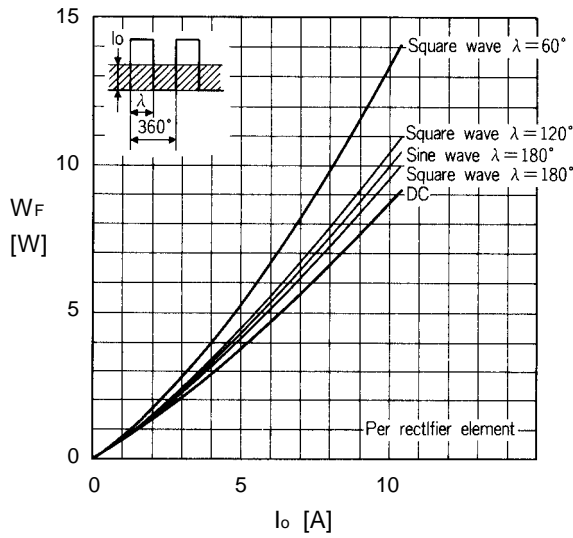

Output current-case temperature

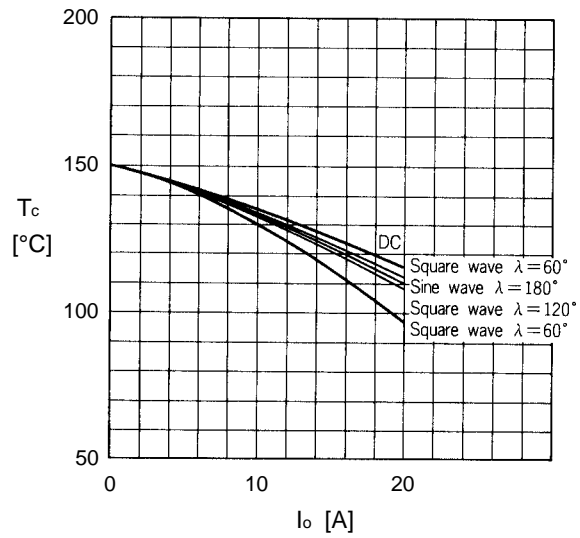

Junction capacitance characteristics

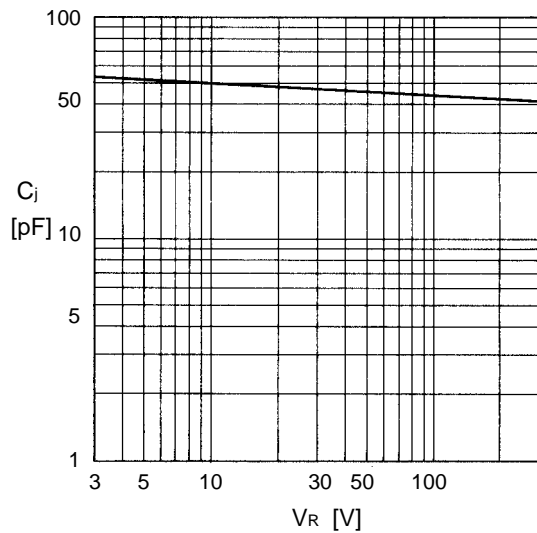

Surge capability

