

# PH967C6 (Ip 30A)

( Ip 30A / 600V )

## Super LLD (For PFC circuit)

### LOW LOSS SUPER HIGH SPEED RECTIFIER

#### ■ Features

- Insulated package by fully molding
- Super high speed switching
- High reliability by planer design

#### ■ Applications

- PFC circuit (current continuous node)

#### ■ Maximum ratings and characteristics

- Absolute maximum ratings

Item	Symbol	Conditions	Rating	Unit
Repetitive peak reverse voltage	$V_{RRM}$		600	V
Non-Repetitive peak reverse voltage	$V_{RSM}$		600	V
Surge peak forward current	$I_{PS}$	$tw \leq 200ns$	40*	A
Peak forward current	$I_P$		30*	A
Average output current	$I_o$	duty=1/2, $T_c=110^\circ C$ Square wave	10*	A
Non-Repetitive surge current	$I_{FSM}$	Sine wave 10ms, 1shot	40	A
Operating junction temperature	$T_j$		150	$^\circ C$
Storage temperature	$T_{stg}$		-40 to +150	$^\circ C$

\* Out put current of centertap full wave connection.

- Electrical characteristics ( $T_a=25^\circ C$  Unless otherwise specified )

Item	Symbol	Conditions	Characteristics	Unit
Reverse recovery peak current**	$I_{RP}$	$I_F=5A, -di/dt=200A/\mu s, V_R=380V, T_j=100^\circ C$	Typ. 2.5	A
Reverse recovery time **	$t_{rr}$	$I_F=0.1A, I_R=0.2A, I_{rec}=0.05A$	Max. 30.0	ns
Forward voltage **	$V_F$	$I_F=15A$	Max. 5.0	V
Reverse current **	$I_R$	$V_R=V_{RRM}$	Max. 50.0	$\mu A$
Thermal resistance	$R_{th(j-c)}$	Junction to case	Max. 1.5	$^\circ C/W$

\*\* Rating per element

- Mechanical characteristics

Mounting torque	Recommended torque	0.4 to 0.6	N·m
Approximate mass		4.9	g

#### ■ Outline drawings, mm

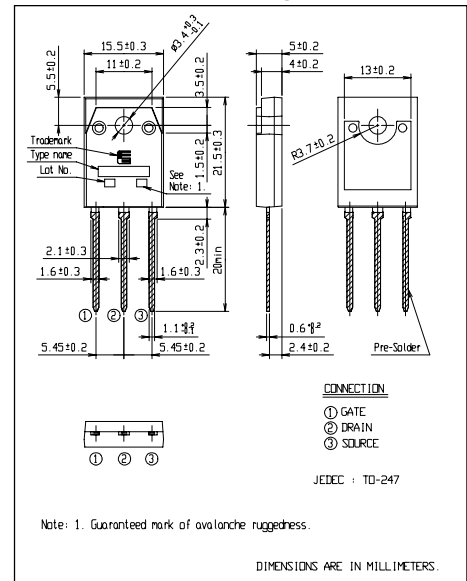

#### ■ Connection diagram

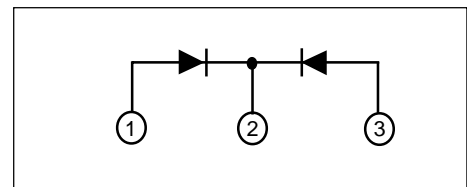

## Characteristics

Forward Characteristic (typ.)

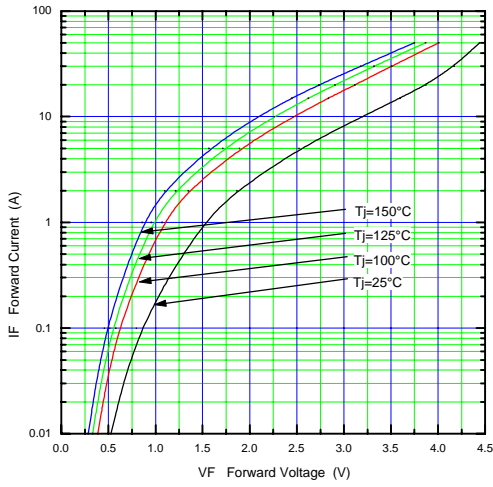

Reverse Characteristic (typ.)

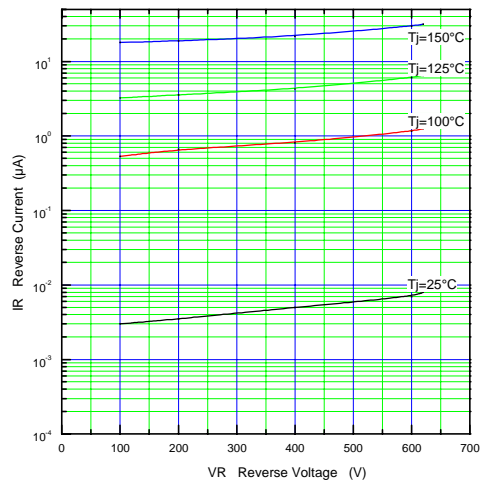

Forward Power Dissipation

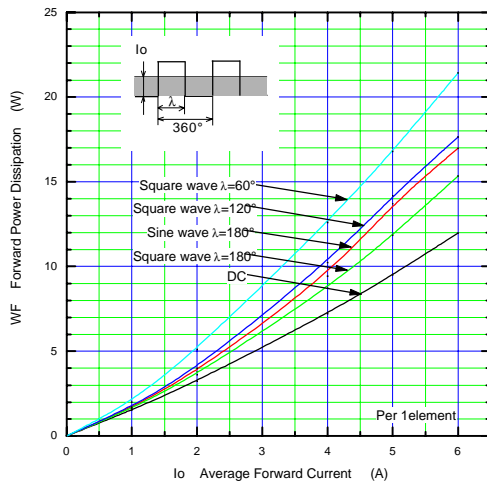

Reverse Power Dissipation

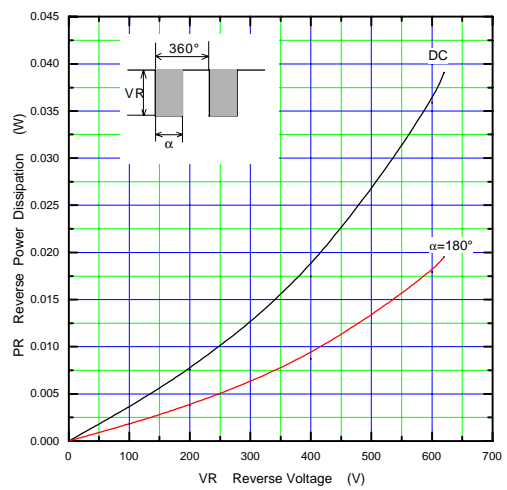

Current Derating (Io-Tc)

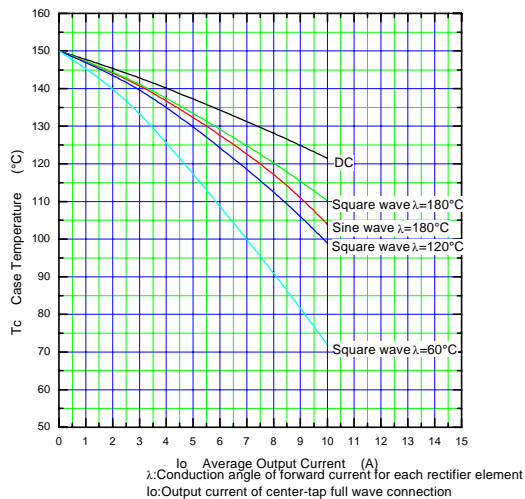

Junction Capacitance Characteristic (typ.)

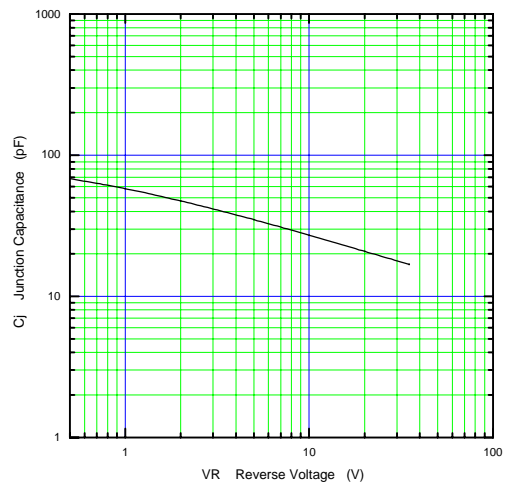

Surge Capability

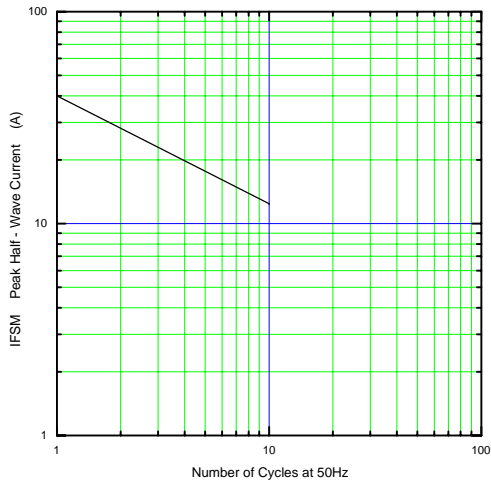

Transient Thermal Impedance

