

## ショットキーバリアダイオード

### SCHOTTKY BARRIER DIODE

#### ■特長：Features

- 面実装品  
Surface mount device.
- 低 $V_F$   
Low  $V_F$
- スイッチングスピードが非常に速い  
Super high speed switching.
- プレーナー技術による高信頼性  
High reliability by planer design.

#### ■用途：Applications

- 高速電力スイッチング  
High speed power switching.

#### ■定格と特性：Maximum Ratings and Characteristics

##### ●絶対最大定格：Absolute Maximum Ratings

Items	Symbols	Conditions	Ratings	Units
ピーク繰り返し逆電圧 Repetitive Peak Reverse Voltage	$V_{RRM}$		40	V
ピーク非繰り返し逆電圧 Non-Repetitive Peak Reverse Voltage	$V_{RSM}$	$tw = 500ns, duty = \frac{1}{10}$	48	V
平均出力電流 Average Output Current	$I_O$	方形波, $duty = \frac{1}{2}, T_c = 87^\circ C$ Square wave	5.0*	A
サージ電流 Surge Current	$I_{FSM}$	正弦波 Sine wave 10ms	60	A
接合温度 Operating Junction Temperature	$T_j$		-40 ~ +125	$^\circ C$
保存温度 Storage Temperature	$T_{stg}$		-40 ~ +125	$^\circ C$

\*センタータップ平均出力電流  
\* average forward current of centertap full wave connction

##### ●電気的特性(特に指定がない限り周囲温度 $T_a = 25^\circ C$ とする)

Electrical Characteristics ( $T_a = 25^\circ C$  Unless otherwise specified)

Items	Symbols	Conditions	Max.	Units
順電圧 Forward Voltage Drop	$V_{FM}$	$I_{FM} = 2.5A$	0.55	V
逆電流 Reverse Current	$I_{RRM}$	$V_R = V_{RRM}$	5	mA
熱抵抗 Thermal Resistance	$R_{th(j-c)}$	接合・ケース間 Junction to case	10	$^\circ C/W$

#### ■外形寸法：Outline Drawings

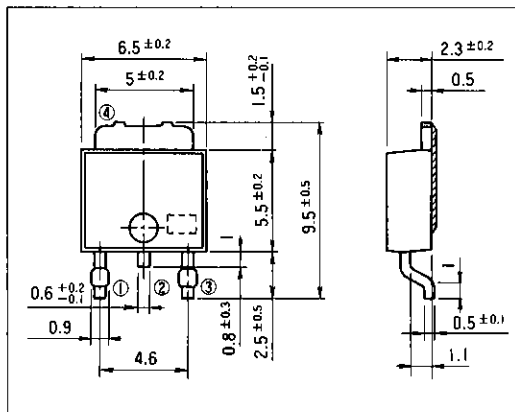

JEDEC	
EIAJ	

#### ■電極接続

##### Connection Diagram

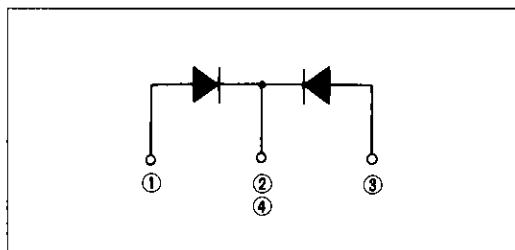

■特性曲線：Characteristics

A

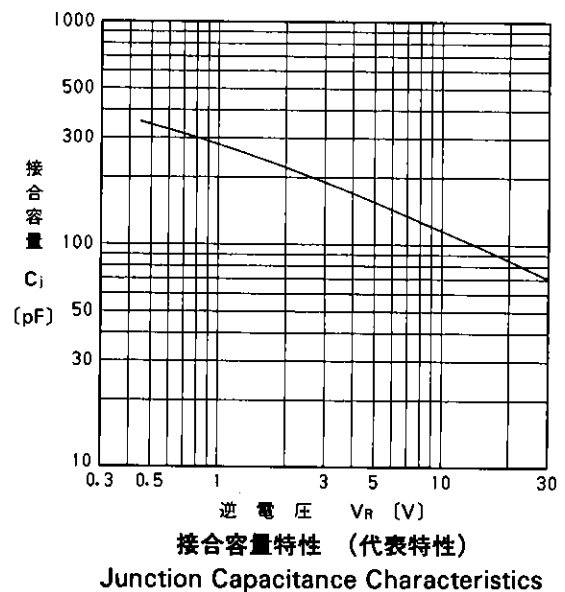
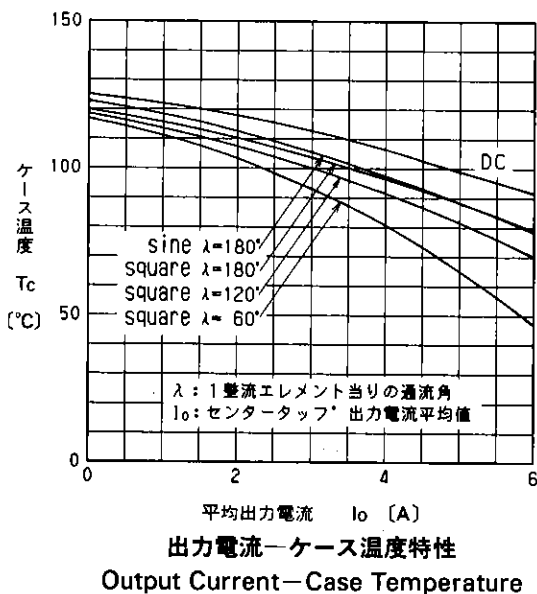
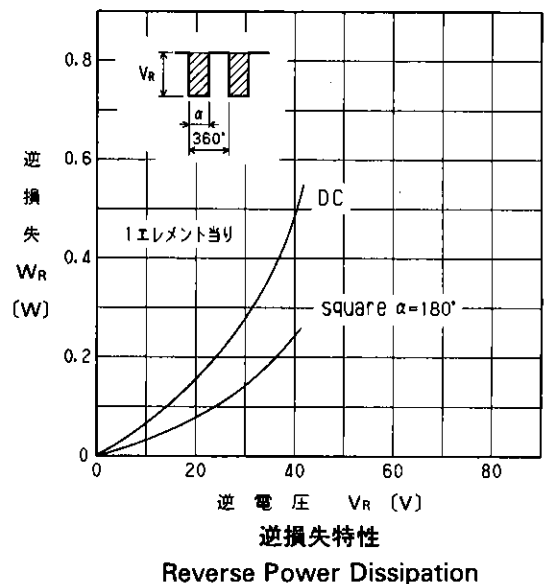
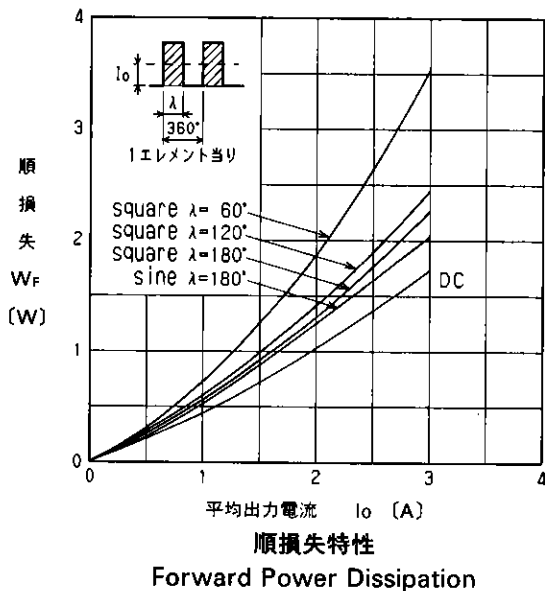
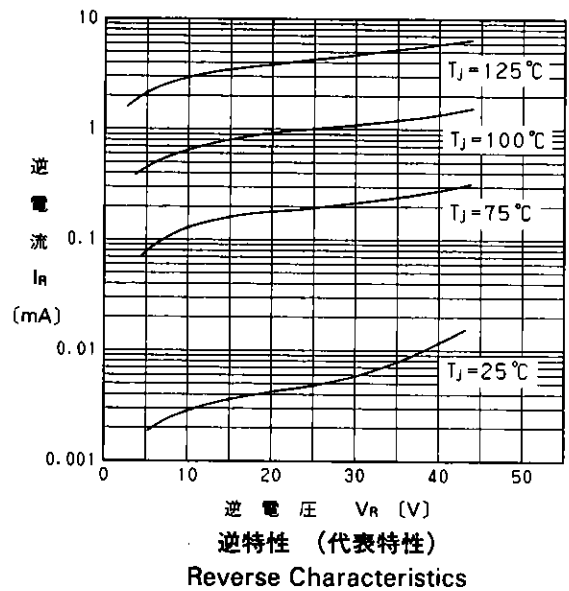
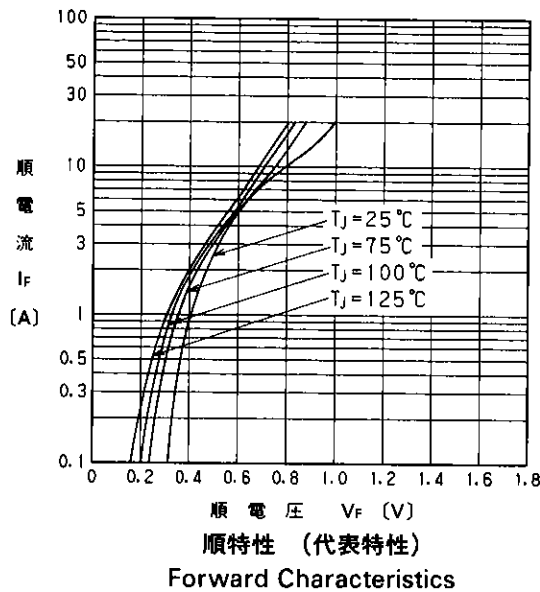

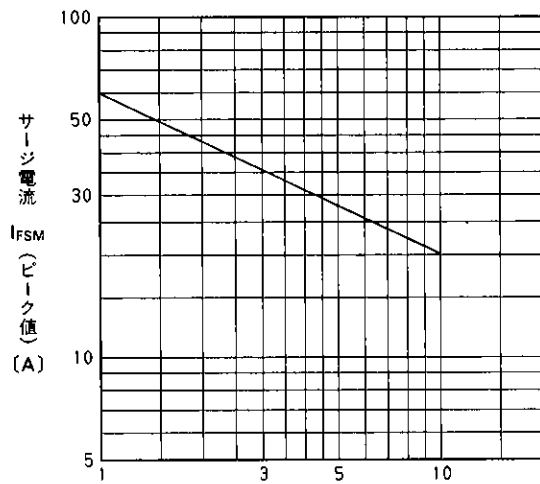

サージ電流耐量  
Surge Capability

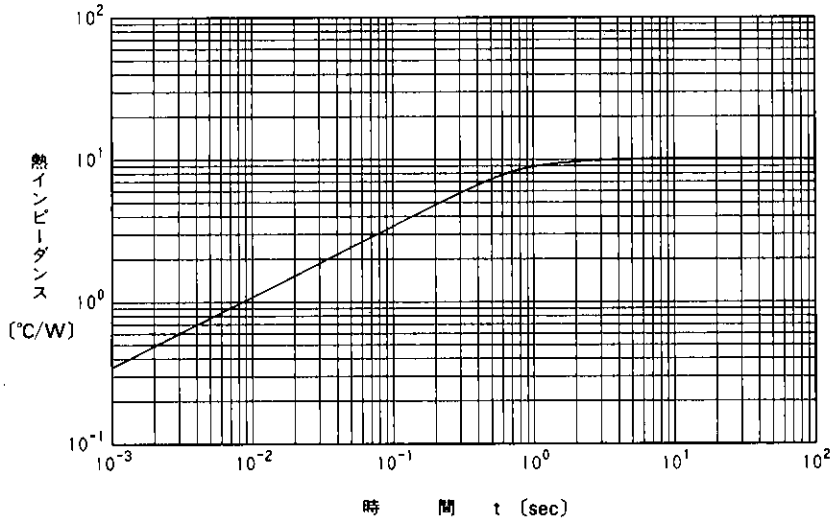

過渡熱インピーダンス  
Transient Thermal Impedance