

SPECIFICATION

Device Name : SILICON DIODE

Type Name : ERW13-060

Spec. No. :

This material and the information herein is the property of Fuji Electric Co.,Ltd. They shall be neither reproduced, copied, lent, or disclosed in any way whatsoever for the use of any third party nor used for the manufacturing purposes without the express written consent of Fuji Electric Co.,Ltd.

Fuji Electric Co.,Ltd.
Matsumoto Factory

	DATE	NAME	APPROVED	Fuji Electric Co.,Ltd.
DRAWN				
CHECKED				
				DWG. NO. 1/6

Ratings and characteristics of Fuji silicon diode

ERW13-060

1. Outline Drawing

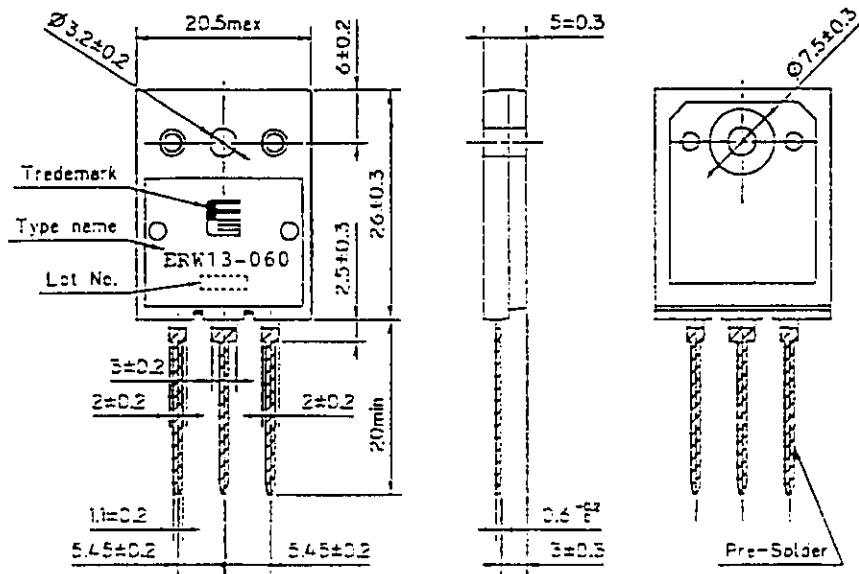

① ② ③

2. Equivalent circuit

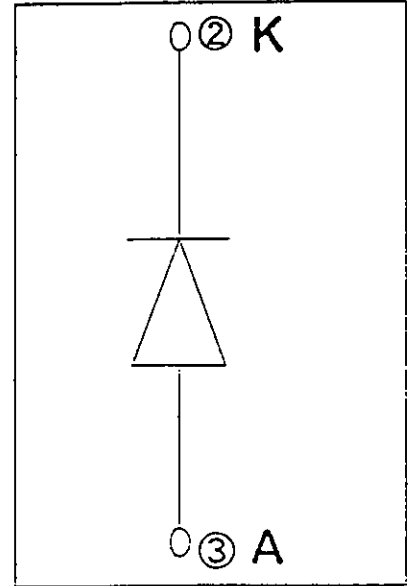

Connection

- ① Open
- ② Cathode
- ③ Anode

3. Absolute maximum ratings (Tc=25°C)

Items	Symbols		Ratings	Unit	
Repetitive Reverse Voltage	VRRM	-	600	V	
Repetitive Peak Surge Current	IFM	20kHz, Duty 50%	Tc= 90°C	50	A
		Squ. wave	Tc= 25°C	88	A
Average Rectified Forward Current	IF(AV)	DC	54	A	
Non-repetitive Peak Surge Current	IFSM	Pulse 10ms, sin wave	125	A	
Maximum Power Dissipation	PD	-	140	W	
Operating Temperature	Tj	-	+150	°C	
Storage Temperature	Tstg	-	-40~+150	°C	
Mounting Screw Torque	-	-	70	N·cm	

This material and the information herein is the property of Fuji Electric Co., Ltd. They shall be neither reproduced, copied, lent, or disclosed in any way whatsoever for the use of any third party nor used for the manufacturing purposes without the express written consent of Fuji Electric Co., Ltd.

4. Electrical Characteristics (at Tc=25°C unless otherwise specified)

Items	Symbols	Characteristics			Conditions	Unit
		min.	typ.	max.		
Reverse Current	IR	-	-	1.0	VR=600V	mA
Forward Voltage	VF	-	-	3.0	IF=50A	V
Reverse Recovery Time	trr	-	-	0.3	IF=50A, VR=200V di/dt=100A/μs	μs

5. Thermal Resistance Characteristics

Items	Symbols	Characteristics			Conditions	Unit
		min.	typ.	max.		
Thermal resistance	Rth(j-c)	-	-	0.89	junction to case	°C/W

This material and the information herein is the property of Fuji Electric Co., Ltd. They shall be neither reproduced, copied, lent, or disclosed in any way whatsoever for the use of any third party nor used for the manufacturing purposes without the express written consent of Fuji Electric Co., Ltd.

Forward voltage vs. Forward current

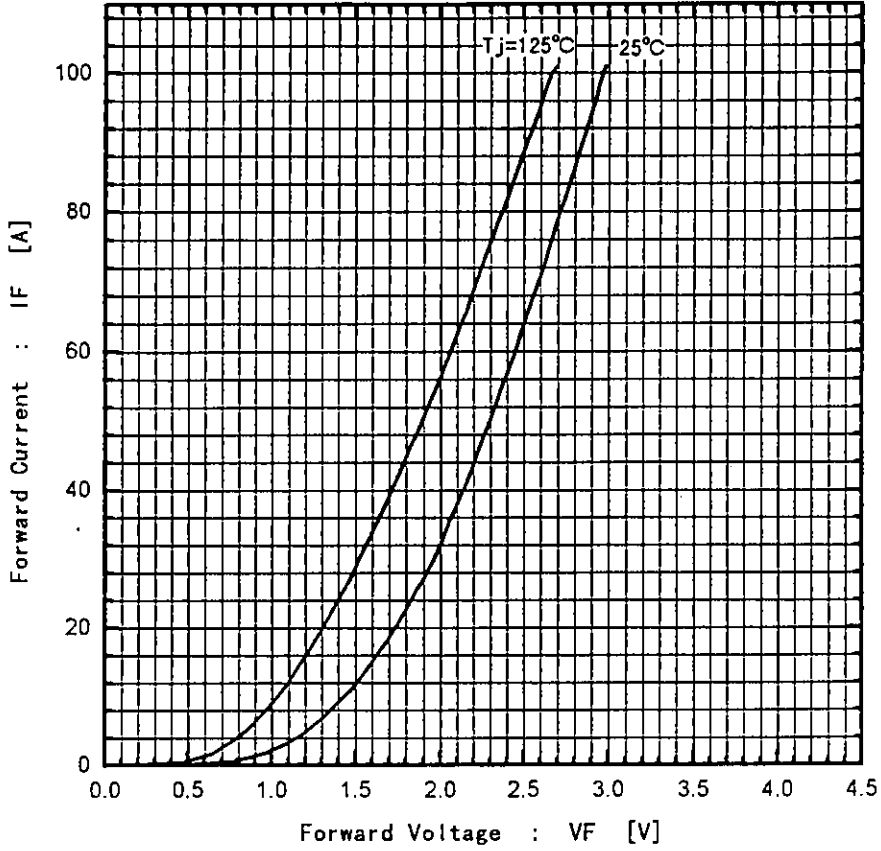

Reverse recovery characteristics vs. $-di/dt$
IF=50A, Tj=125°C

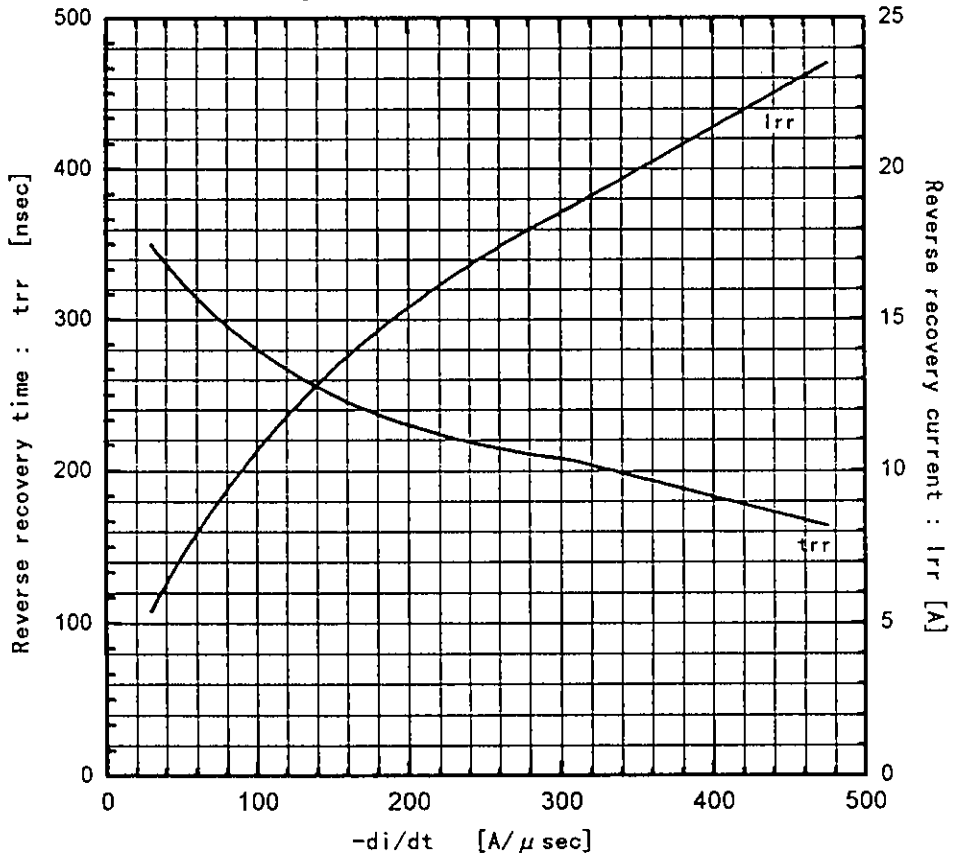

This material and the information herein is the property of Fuji Electric Co., Ltd. They shall be neither reproduced, copied, lent, or disclosed in any way whatsoever for the use of any third party nor used for the manufacturing purposes without the express written consent of Fuji Electric Co., Ltd.

This material and the information herein is the property of Fuji Electric Co., Ltd. They shall be neither reproduced, copied, lent, or disclosed in any way whatsoever for the use of any third party nor used for the manufacturing purposes without the express written consent of Fuji Electric Co., Ltd.

Reverse recovery time vs. Forward current
VR=200V, $-di/dt=100A/\mu\text{sec}$

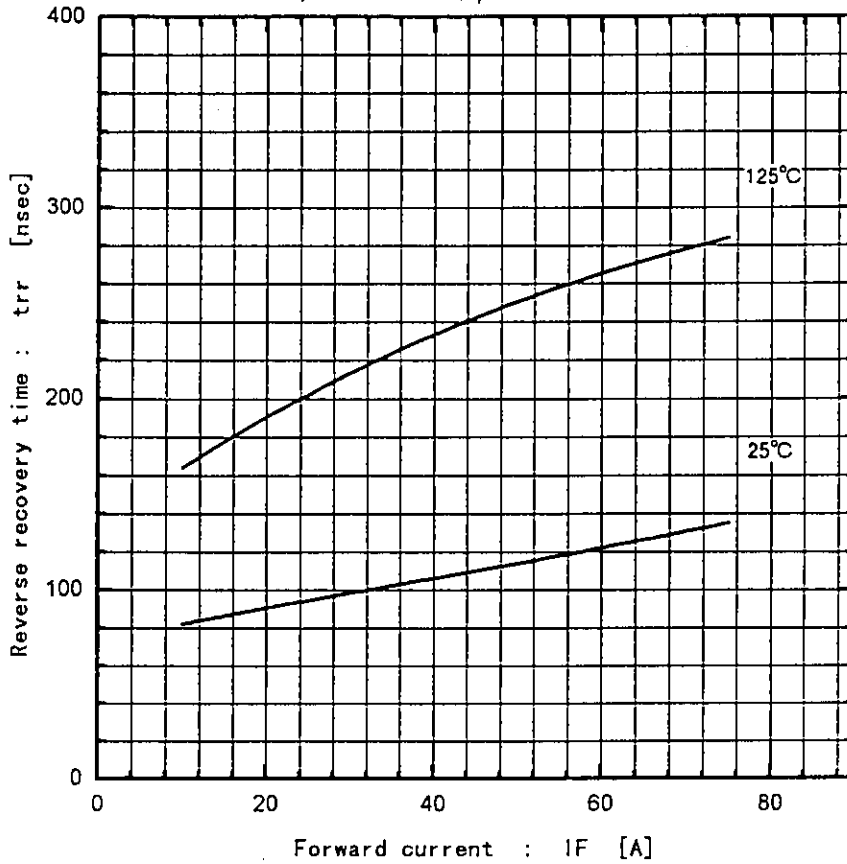

Reverse recovery current vs. Forward current
VR=200V, $-di/dt=100A/\mu\text{sec}$

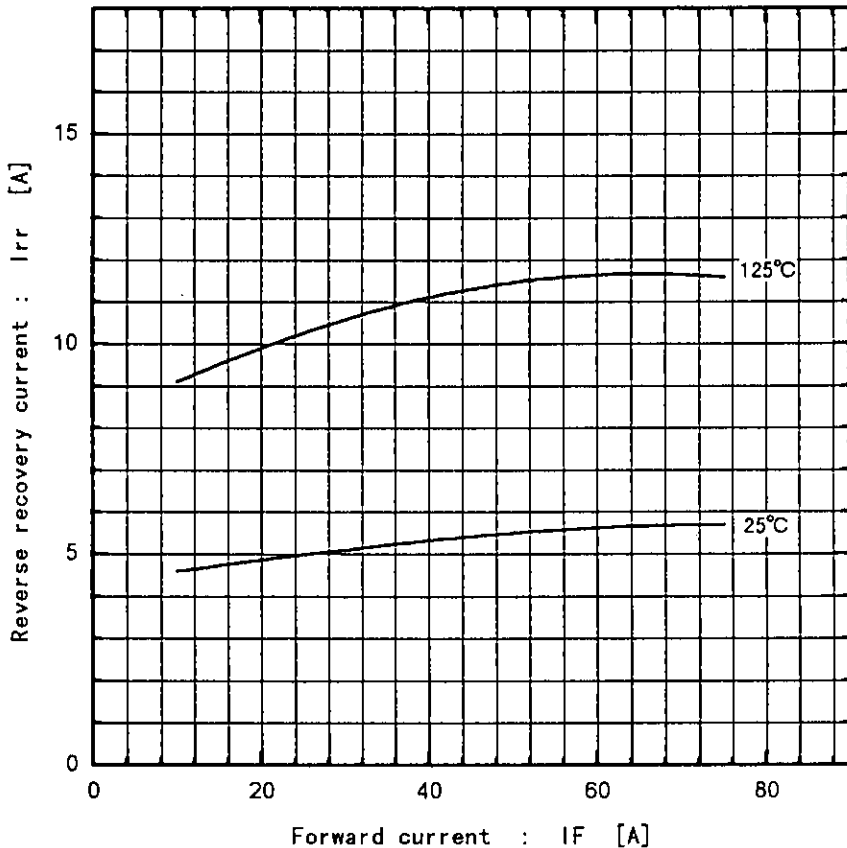

This material and the information herein is the property of Fuji Electric Co., Ltd. They shall be neither reproduced, copied, lent, or disclosed in any way whatsoever for the use of any third party nor used for the manufacturing purposes without the express written consent of Fuji Electric Co., Ltd.

ERW13-060 Transient thermal resistance

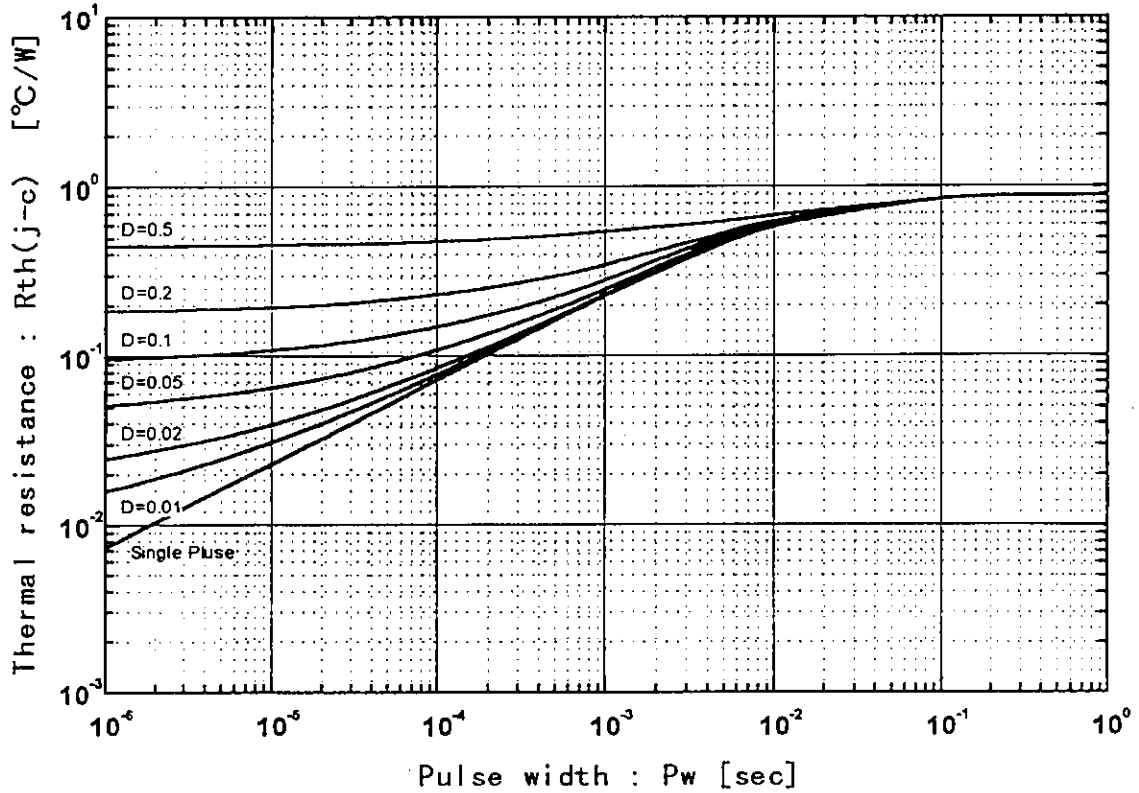

Forward current vs. Max. allowable case temperature

