

6RI50E(50A)

POWER DIODE MODULE

600V,800V / 50A

6 in one-package

Features

- Glass Passivation Chip
- Easy Connection
- Insulated Type

Applications

- Inverters
- Battery Chargers
- DC Motors
- General Purpose DC Power Supplies

Maximum ratings and characteristics

Absolute maximum ratings

Item	Symbol	Conditions	Rating		Unit
			-060	-080	
Repetitive peak reverse voltage	V_{RRM}		600	800	V
Non-repetitive peak reverse voltage	V_{RSM}		660	880	V
Average output current	I_O	50/60Hz Sine wave, $T_c=102^\circ\text{C}$	50		A
Surge current	I_{FSM}	From rated load, Sine wave 10ms	480		A
I^2t	I^2t	From rated load	920		A^2s
Operating junction temperature	T_j		-40 to +150		$^\circ\text{C}$
Storage temperature	T_{stg}		-40 to +125		$^\circ\text{C}$
Isolation voltage	V_{is}		AC2000(1min.)		V
Screw torque			1.7 *1		N·m

*1: Recommendable value : 1.3 to 1.7 N·m(M4)

Electrical characteristics (Ta=25°C Unless otherwise specified)

Item	Symbol	Conditions	Min.	Typ.	Max.	Unit
Forward voltage drop	V_{FM}	$T_j=25^\circ\text{C}$, $I_{FM}=50\text{A}$			1.20	V
Reverse current	I_{RRM}	$T_j=150^\circ\text{C}$, $V_R=V_{RRM}$			5.0	mA

Thermal Characteristics

Item	Symbol	Conditions	Min.	Typ.	Max.	Unit
Thermal resistance	$R_{th(j-c)}$	Junction to case			0.42	$^\circ\text{C}/\text{W}$
	$R_{th(c-f)}$	the base to cooling fin *			0.10	$^\circ\text{C}/\text{W}$

* : With Thermal Compound

Outline Drawings, mm

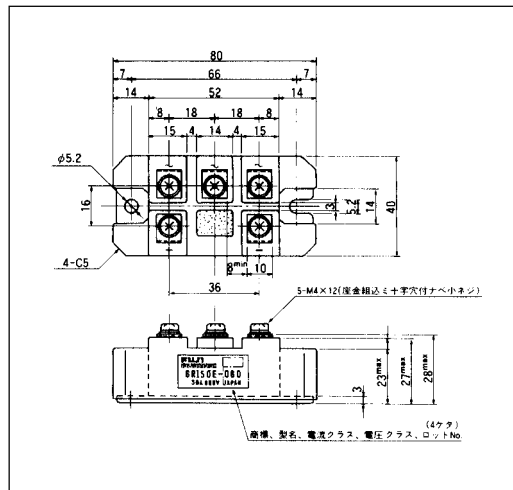

Inner Circuit Schematic

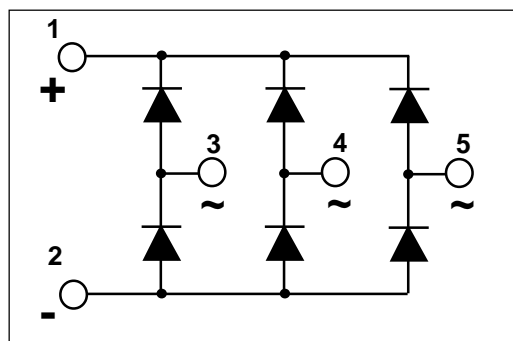

■ Characteristics

Forward Characteristics

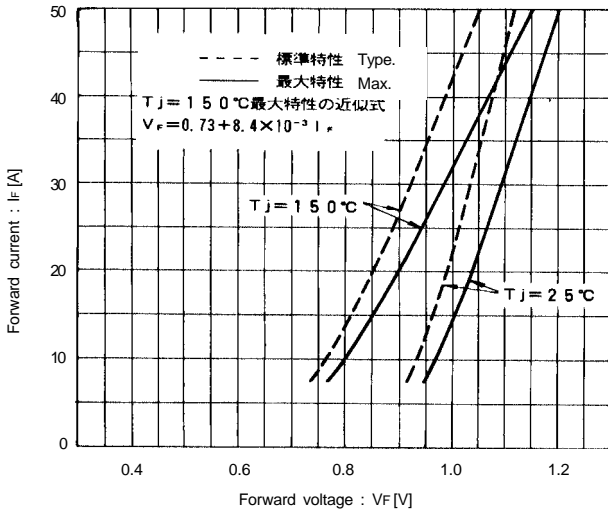

Forward Average Current vs. Power Loss

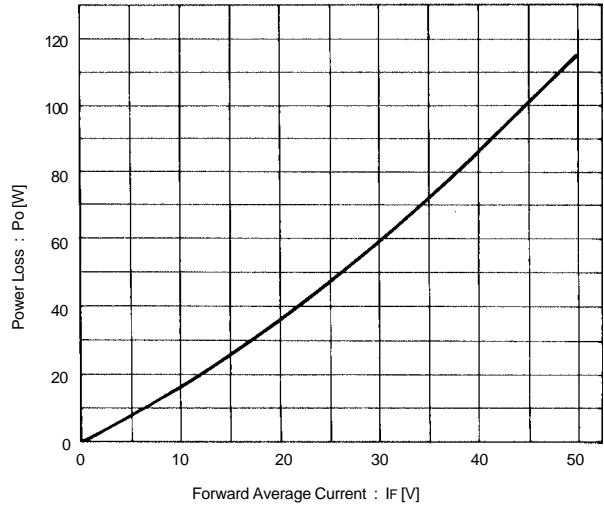

Forward Average Current vs. Case Temperature

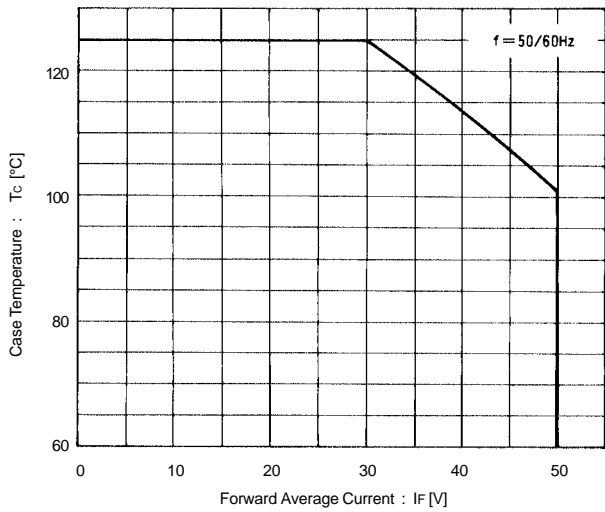

Surge Current

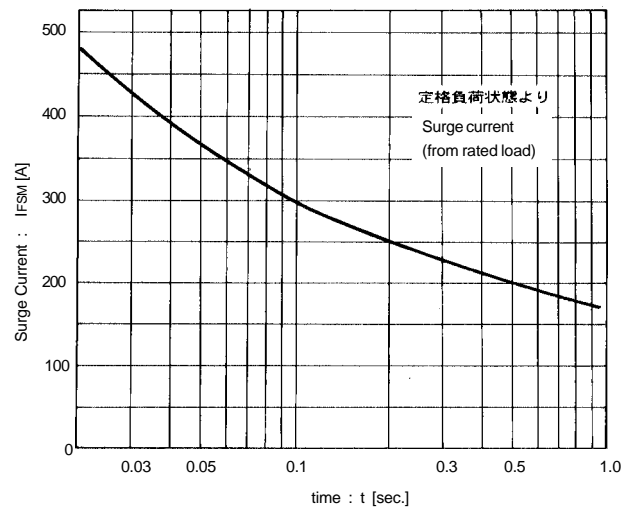

Transient Thermal Impedance

